

*Simpson*

**Simpson 260<sup>®</sup> Series 8XI  
Volt-Ohm-Milliammeter  
INSTRUCTION MANUAL**



#### About this Manual

To the best of our knowledge and at the time written, the information contained in this document is technically correct and the procedures accurate and adequate to operate this instrument in compliance with its original advertised specifications.

#### Notes and Safety Information

This Operator's Manual contains warning headings which alert the user to check for hazardous conditions. These appear throughout this manual where applicable, and are defined below. To ensure the safety of operating performance of this instrument, these instructions must be adhered to.

Warning, refer to accompanying documents.



Warning. Refer to accompanying documents



Caution, risk of electric shock.



This instrument is designed to prevent accidental shock to the operator when properly used. However, no engineering design can render safe an instrument which is used carelessly. Therefore, this manual must be read carefully and completely before making any measurements. Failure to follow directions can result in serious or fatal accident.

**Shock Hazard:** As defined in American National Standard, C39.5, Safety Requirements for Electrical and Electronic Measuring and Controlling Instrumentation, a shock hazard shall be considered to exist at any part involving a potential in excess of 30 volts RMS (sine wave) or 42.4 volts DC or peak and where a leakage current from that part to ground exceeds 0.5 milliampere, when measured with an appropriate measuring instrument defined in Section 11.6.1 of ANSI C 39.5.

#### Technical Assistance

SIMPSON ELECTRIC COMPANY offers assistance Monday through Friday 7:30 am to 5:00 pm Central Time by contacting Technical Support or Customer Service at (847) 697-2260.

Internet: <http://www.simpsonelectric.com>

#### Warranty and Returns

SIMPSON ELECTRIC COMPANY warrants each instrument and other articles manufactured by it to be free from defects in material and workmanship under normal use and service, its obligation under this warranty being limited to making good at its factory or other article of equipment which shall within one (1) year after delivery of such instrument or other article of equipment to the original purchaser be returned intact to it, or to one of its authorized service centers, with transportation charges prepaid, and which its examination shall disclose to its satisfaction to have been thus defective; this warranty being expressly in lieu of all other warranties expressed or implied and of all other obligations or liabilities on its part, and SIMPSON ELECTRIC COMPANY neither assumes nor authorizes any other persons to assume for it any other liability in connection with the sales of its products.

This warranty shall not apply to any instrument or other article of equipment which shall have been repaired or altered outside the SIMPSON ELECTRIC COMPANY factory or authorized service centers, nor which has been subject to misuse, negligence or accident, incorrect wiring by others, or installation or use not in accord with instructions furnished by the manufacturer.

260® is a Registered Trademark of the Simpson Electric Company.

**NOTES:**

# Contents

1.	INTRODUCTION .....	7
1.1	General Description .....	7
1.2	Overload Protection .....	7
1.3	Internal Batteries .....	7
1.4	Printed Circuit .....	8
1.5	Case .....	8
1.6	Adjust-A-View Handle .....	8
1.7	Test Leads .....	8
1.8	Technical Data .....	8
1.9	Definition of Accuracy .....	10
1.10	Safety Considerations .....	10
1.11	Audio Alarm .....	10
1.12	Accessories .....	10
1.13	Additional Accessories .....	11
1.13.1	Accessory DC High Voltage Probes .....	11
1.13.2	Accessory AC High Voltage Probe .....	11
1.13.3	Amp-Clamp Model 150-2 .....	11
2.	INSTALLATION .....	12
2.1	Unpacking and Inspection .....	12
2.2	Warranty .....	12
2.3	Shipping .....	12
2.4	Power Source Requirements .....	12
2.5	Operating Position .....	12
3.	CONTROLS, JACKS AND INDICATORS .....	13
3.1	Front Panel Description .....	13
4.	OPERATION .....	14
4.2	Safety Precautions .....	14
4.3	Polarity Reversing .....	16
4.4	Measurement of Unknown Voltage or Current .....	16
4.5	Test Leads .....	16
4.6	DC Voltage Measurement .....	16
4.6.1	DC Voltage Measurement 0-250 mV Range .....	16
4.6.2	DC Voltage Measurement 0-2.5 Through 0.250V Range .....	17
4.6.3	DC Voltage Measurement 0-500V Range .....	17
4.6.4	DC Voltage Measurement 0-1000V Range .....	18
4.7	AC Voltage Measurement .....	19
4.7.1	AC Voltage Measurement 0-2.5 Through 0-250V Range .....	19
4.7.2	AC Voltage Measurement 0-500V Range .....	20
4.7.3	AC Voltage Measurement 0-1000 Range .....	21
4.7	Output Voltage Measurement .....	21
4.8	Decibel Measurement (-20 to +50 dB) .....	22
4.9	Direct Current Measurement .....	23
4.9.1	Direct Current Measurement 0-50 $\mu$ A Range .....	24
4.9.2	Direct Current Measurement 0-1mA through 0-500mA Range ...	24
4.9.3	Direct Current Measurement 0-10A Range .....	25
4.10	Zero Ohms Adjustment .....	25
4.11	Measuring Resistance .....	26
4.12	Resistance Measurement of Semiconductors .....	26
4.13	Continuity Tests .....	27

## Contents, Continued

5	OPERATOR SERVICING .....	28
5.1	Battery and Fuse Replacement .....	28
5.2	Fuse Protection .....	29
5.3	Care .....	29
6	PARTS LIST AND SCHEMATIC DIAGRAM .....	30
6.1	Removing the Instrument Case. ....	30
6.2	Replacement Parts and Schematic Diagram .....	30

**NOTES:**

# 1. INTRODUCTION

---

## 1.1 General Description

---

The Simpson Volt-Ohm-Milliammeter 260 Series 8XI, (hereafter referred to as the 260 or as the Instrument) is a rugged, accurate, compact, easy-to-use instrument equipped with mirrored dial to eliminate parallax. The Instrument can be used to make accurate measurements of AC and DC voltage, direct current, resistance, decibels, and Output Voltage. The Output Voltage function is used for measuring the AC component of a mixture of AC and DC voltage. This occurs primarily in amplifier circuits.

New Features in the 260 are:

0 - 25V AC/DC Range

Continuity Test Alarm

Individual Dual Jacks for the 500V AC/DC and 1000V AC/DC Ranges

High Impact Case (Yellow)

## 1.2 Overload Protection

---

No single protective device nor even a combination of devices as found in the 260 can fully protect a multi-purpose Instrument under all overload conditions. Despite all the built-in protection provided, overloads severe enough to damage the Instrument are possible when the Instrument is misused.

The fuse in the 260 affords maximum Instrument protection under overload conditions which might occur within the measuring capabilities of the Instrument, however, the operator must exercise care to avoid severe overloads, particularly when working in high voltage circuits.

Basic overload protection is provided by a small inexpensive, and easily obtainable 3 AG type, 1 ampere, quick-blow fuse. This fuse is rated to interrupt circuit voltages up to 250 volts. For maximum protection it is important to replace the 1A fuse with the Littlefuse type 312001 only.

A supplemental high energy fuse is provided for additional protection from severe overloads. This fuse is rated for an interruption capacity of 10,000 amperes up to 600 volts. (Littlefuse Type BLS or Bussman Type BBS). If the Instrument fails to indicate a reading, the 1 Amp or the 2 Amp fuse may be burned out. (Refer to paragraph 5.2 for fuse replacement.) A 1 Amp spare fuse is furnished with each Instrument. Fuses are located in the battery and fuse compartment.

**NOTE:** The 0-10A range is not fused. The shunt connects directly to the -10A and +10A jacks.

Two diodes connected across the meter movement affords protection to the movement by circumventing excessive current around the movement in the event of an overload.

## 1.3 Internal Batteries

---

There are two batteries in the ohmmeter circuits. One is a NEDA 13F size D cell that furnishes 1.5-volts for the R X 1 and R X 100 ranges. A NEDA 1604A alkaline battery furnishes 9-volts for the R X 10,000 range. The 1.5-volt D cell is held in place with two spring clips which also serve as battery contacts. The polarity symbols for the D cell are marked near the battery contacts. The 9-volt battery is held in place with a spring clip, but contact is made with a separate connector that is polarized. Always observe correct polarity when replacing the 1.5-volt D cell.

## 1.4 Printed Circuit

---

Most of the component parts are mounted on a printed circuit board which simplifies assembly and maintenance, thus extending the useful life of the Instrument.

## 1.5 Case

---

The case has an externally accessible battery and fuse compartment. Access to the batteries and 1 amp fuse is obtained by unscrewing a single screw on the back of the case and sliding out the compartment cover.

## 1.6 Adjust-A-Vue Handle

---

A carrying handle is attached to the Instrument case. The handle may be used to support the Instrument in a convenient sloping position for easy viewing. The case can also be placed in either a vertical or horizontal position. The horizontal position is preferable for greater accuracy since the Instrument is calibrated in this position.

## 1.7 Test Leads

---

Each Instrument is furnished with one pair (Catalog No. 00125) of probe type test leads (one red and one black, each 48 inches long) for all applications of the Instrument. These test leads have elbow prods on one end to connect the leads to the recessed jacks on the Instrument front panel. The probe tips at the opposite end have threaded shoulders to accept the screw-on insulated alligator clips (furnished with the test leads) or the 5000 volt test probe(s) to extend the Instrument's AC or DC voltage range. The test leads and the insulated alligator clips are rated for the voltage and current ranges available on the 260. Maximum ratings are 1000V AC or DC or 10 DC amps. Do not exceed these ratings for the test leads in any application.

## 1.8 Technical Data

---

*Table 1-1. Technical Data*

1.	DC VOLTS:	
	Ranges:	0-1-2.5-10-25-50-250-500-1000V
	Sensitivity:	20,000V per Volt
2.	DC MILLIVOLTS:	
	Range:	0-250mV
	Sensitivity:	20,000 per Volt
3.	AC VOLTS:	
	Ranges:	0-2.5-10-25-50-250-500-1000V
	Sensitivity:	5,000V per Volt
4.	OUTPUT VOLTAGE (AC):	
	Ranges:	0-2.5-10-25-50-250 (limited to 350V DC)
5.	DC MICROAMPERES:	
	Range:	0-50 $\mu$ A
	Voltage Drop:	250mV



6. DC MILLIAMPERES:  
 Ranges: 0-1-10-100-500 mA  
 Voltage Drop  
 (Approx.): 250 mV, 255 mV, 300 mV, 500 mV
7. DC AMPERES:  
 Range: 0-10A  
 Voltage Drop  
 (Approx.): 255 mV

**NOTE:** The 10A range is **not** internally fused.

8.

Resistance	RX1	RX100	RX1000
Range	0-2000Ω	0-200,000Ω	0-20MΩ
Center Reading	12Ω	1200Ω	120,000Ω
Nominal Open Circuit Voltage	1.5V	1.5V	9V
Nominal Short Circuit Current	125mA	1.25mA	75μA

9. \*ACCURACY:  
 DC Voltage Ranges: 2% of Full Scale  
 DC Current:  
 0-50 μA Range: 1.5% of Full Scale  
 Other Ranges: 2% of Full Scale  
 \*\*AC Voltage Ranges: 3% of Full Scale  
 Frequency Response: Referenced to 100 Hz (Figures 4-4 and 4-8)  
 Resistance Ranges:  
 R X 1: 2.5° of Arc  
 R X 100: 2° of Arc  
 R X 10,000: 2° of Arc
10. DECIBELS:  
 Range: -20 to +10 dB, -8 to +22 dB, 0 to +30 dB, +6 to +36 dB, +20 to +50 dB  
 Reference Level: With zero dB power level equal to 1 mW across a 600V line.
11. BATTERIES:  
 Voltage: 1.5V, 9V  
 NEDA No.: 13F, 1604A
12. FUSE:  
 F1 1A, 250V, type 3AG, quick-acting Littlefuse Type 312001, F2 2A, 600V Littlefuse Type BLS or 2A 600V, Bussman Type BBS.
13. TEST LEADS: 1 red, 1 black, 48" long.
14. SIZE: 5 1/4" x 7" x 3 1/8" (13.34 x 17.78 x 7.94 cm)

15. WEIGHT: 2 1/2 lbs. (0.9331 kg)

16. \*\*\*RATED-CIRCUIT-

TO-GROUND VOLTAGE: 1000 V AC/DC Max.

\* Accuracies specified are for the 260 in a horizontal position.

\*\* Responds to the average value of an AC current, and is calibrated to indicate the RMS value of a pure sine wave.

\*\*\* Per ANSI C39.5 April 1974: The specified voltage with respect to ground, which may be safely and continuously applied to the circuit of an Instrument.

## 1.9 Definition of Accuracy

---

The voltage and current accuracy of this Instrument is commonly expressed as a percent of full scale. This should not be confused with accuracy of reading (indication). For example, +2% of full scale on the 10V range allows an error of  $\pm 0.20V$  at any point on the dial. This means that at full scale, the accuracy reading would be  $\pm 2\%$ , but at half scale it would be  $\pm 4\%$ . Therefore, it is advantageous to select a range which gives the closest indication to full scale.

## 1.10 Safety Considerations

---

This Operator's Manual contains cautions and warnings alerting the user to hazardous operating and service conditions. This information is flagged by CAUTION or WARNING symbols where applicable, throughout this publication, and is defined on the inside front cover of this manual under Notes and Safety Information. Adhere to these instruction in order to ensure the safety of operating and servicing personnel and to retain the operating conditions of the Instrument.

## 1.11 Audio Alarm

---

The 260 Audio Alarm transducer will emit an audio sound when the continuity of a circuit being tested is completed.



No circuit continuity tests are to be made with electrical power "ON." Turn "OFF" all electrical power.

## 1.12 Accessories

---

*Table 1-2. Items and Accessories Furnished with this Instrument*

Quantity	Description	Number
1	Test Lead Set - one red and one black (48" long) each with combination probe tip and removable rubber-sleeved alligator clip.	00125
*1	1.5 Volt, D Cell, NEDA 13F	
*1	9.0 Volt Cell, NEDA 1604A	
2	1 Amp, 250V Fuse, Littlefuse Type #312001	
1	2A, 600V Fuse, Littlefuse Type BLS (or Bussman Type BBS)	
1	Operator's Manual	6-115021

\* Batteries are standard items replaceable at local retail stores.

## 1.13 Additional Accessories

Table 1-3. Additional Accessories

Description	Catalog No.
Deluxe Case .....	00812
Vinyl Sheath Case .....	01818
Leatherette Ever-Redy Hard Case, Drop Front .....	00805
5,000 Volt AC Probe 5 k $\Omega$ /V .....	00794
5,000 Volt DC Probe 20 k $\Omega$ /V .....	00795
10,000 Volt AC Probe 5 k $\Omega$ /V .....	00036
10,000 Volt DC Probe 20 k $\Omega$ /V .....	00034
Model 150-2 Amp-Clamp .....	00541
Model 151-2 Line Splitter .....	00544



High voltage probes and test prod adapters provide a convenient and economical means of extending the voltage range of the 260. They are intended for high voltage measurements in low power, consumer type products such as TV receivers, oscilloscopes, burner ignition systems, etc. They are NOT intended for and should NOT be used for measurements in high power circuitry such as power substations or distribution centers, RF induction heaters or broadcast transmitters, x-ray equipment or other applications where an operator error may create a dangerous condition.

### 1.13.1 Accessory DC High Voltage Probes

The DC high voltage probes are designed for use with the Simpson 260 or any 20,000 ohms per volt VOM having a 2.5 volt DC range and scale graduations from 0-10 or multiple thereof for the 10 kV probe.

Accuracy: Probe Resistance 2%. DC high voltage test probes are available at local electronic parts distributors.

### 1.13.2 Accessory AC High Voltage Probe

The 10,000 volts AC accessory probe is similar to the high voltage DC probes with the following exceptions: The AC high voltage probe is designed to extend the 260-8 AC voltage range. The probe can be used with the Simpson 260, 10 volt AC range.

**NOTE:** Instructions are furnished with each high voltage probe.

### 1.13.3 Amp-Clamp Model 150-2

The Simpson Amp-Clamp Model 150-2 allows AC current measurements without breaking the circuit under test. The Amp-Clamp works as a transformer containing a split core for accommodating the conductor which carries the current being measured. The current-carrying conductor becomes the transformer primary and a coil in the Amp-Clamp serves as the secondary winding. The Amp-Clamp output voltage is proportional to the current measured and can be applied to the 260 as an AC voltage.

The Amp-Clamp has a range selector with 6 positions. Any of the following current ranges can be used with the 260: 5, 10, 25, 50, 100 or 250 amperes.

**NOTE:** Instructions are furnished with each Amp-Clamp.

## **2. INSTALLATION**

---

This section contains information and instructions for the installation and shipping of the Instrument. Included are unpacking and inspection procedures, warranty, shipping, power source requirements and operating position.

### **2.1 Unpacking and Inspection**

---

Examine the shipping carton for signs of damage. If damaged, notify the carrier and supplier and do not attempt to use the Instrument. If the Instrument appears to be in good condition, read Operator's Manual in its entirety. Become familiar with the Instrument as instructed in the manual, then check the electrical performance as soon as possible. Check that all items are included with the Instrument (Refer to Table 1-2).

A 1.5V battery and a 9V battery may be found in separate envelopes in the box with the Instrument and the test leads. Two alligator clips for the test leads are in a polyethylene bag. (See Section 5 for instructions on how to install the batteries.)

### **2.2 Warranty**

---

The Simpson Electric Company warranty policy is printed on the inside front cover of this manual. Read carefully before requesting warranty repairs.

For all assistance, contact the nearest Authorized Service Center or the factory directly. Give full details of any installation difficulties and include the Instrument model number, series number, and date of purchase. Service data or shipping instructions will be mailed promptly. If an estimate of charges for non-warranty or other service work is required, a maximum charge estimate will be quoted. This charge will not be exceeded without prior approval.

### **2.3 Shipping**

---

Pack the Instrument carefully and ship it, prepaid and insured, to the proper destination.

### **2.4 Power Source Requirements**

---

There are two batteries in the ohmmeter circuits: One is a NEDA 13F D size cell that furnishes 1.5 volts for the R X 1 and R X 100 ranges. A NEDA 1604A battery furnishes 9 volts for the R X 10,000 range. The 1.5 volt D cell is held in place with two spring clips which also serve as battery contacts. The 9-volt battery is held in place with a spring clip but contact is made with a separate connector that is polarized. (Always observe correct polarity when replacing the 1.5-volt D cell.)

### **2.5 Operating Position**

---

A handle is attached to the side of the Instrument case. The handle may be used to support the Instrument in a convenient, sloping position for easy viewing. The VOM case can also be placed either in a vertical or horizontal position. The horizontal position is preferable for greater accuracy since the Instrument is calibrated in this position.

### 3. CONTROLS, JACKS AND INDICATORS

#### 3.1 Front Panel Description

All operating and adjustment controls, jacks, and indicators for the Instrument are illustrated in this section along with a list (Table 3-1) describing their function. Become familiar with each item before operating the Instrument.

Table 3-1. Controls, Jacks and Indicators

1. Front Panel: The 260 is a large, easy-to-read 4-1/2" indicating Instrument. Below the Instrument are three controls and seven circuit jacks. Switch positions and circuit jacks are marked in black characters for easy reading.
2. Range Switch: This switch is used to select one of the twelve range positions.

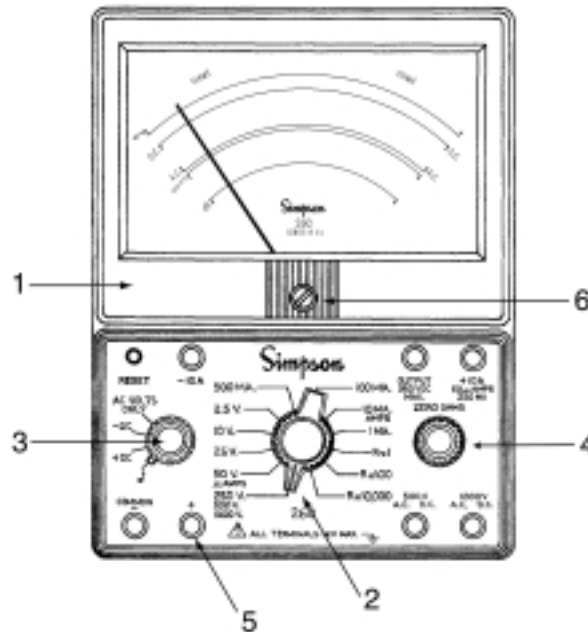

Figure 3-1. Front Panel Controls, Jacks and Indicators

3. Function Switch: The function switch has four position: ♪ (Audio), +DC, -DC, and AC Volts Only. To measure DC current or voltage, set the function switch at the -DC or +DC position, depending on the polarity of the signal applied across the test leads. To measure AC voltage, set the function switch to the AC position. For resistance measurement, the switch may be set in either the +DC or -DC position. The polarity of the internal ohmmeter battery voltage will be as marked at the jacks when the switch is in the +DC position and reversed in the -DC position. To check circuit continuity set the function switch to the “♪” position.

4. Zero Ohms: This control is used to compensate for variations in the voltage of the internal batteries when making resistance measurements.
5. Circuit Jacks: There are seven jacks on the front panel marked with the functions they represent (Figure 3-1). These jacks provide the electrical connections to the test leads. The COMMON (-) jack is used (in conjunction with the black test lead) as the reference point for the measurement of all the functions with the exception of the 10A range.
6. Pointer Adjust For Zero: With the Volt-Ohm-Milliammeter in an operating position, check that the pointer indicates zero at the left end of the scale when there is no input. If pointer is off zero, adjust the screw located in the cover below the center of the dial. Use a small screwdriver to turn the screw slowly clockwise or counterclockwise until the pointer is exactly over the zero mark at the left end of the scale. With the indicating pointer set on the zero mark, reverse the direction of the rotation of the zero adjuster slightly to introduce mechanical freedom or "play", but not enough to disturb the position of the indicating pointer. This procedure will avoid disturbances to the zero setting by subsequent changes in temperature, humidity, vibration, and other environmental conditions.

## 4. OPERATION

---

This section of the manual contains information required to use and operate the Instrument in a safe and proper manner.



Multifunction instruments (VOM's) such as the 260-8 are intended as general purpose measuring Instruments for use in low power circuitry such as found in consumer appliances, TV and radio receivers, and in general laboratory applications. Their use is not recommended in high voltage, high power circuitry where operator errors and inadequate personal protective measures could result in serious injury from arcing or explosion. Such circuitry is found in industrial or commercial applications such as induction (r-f) heaters and broadcast transmitters, power substations and distribution centers, x-ray equipment, large motor controls, etc. Working in the high voltage section of such equipment requires single-function, often specially designed instruments used by specially trained personnel using appropriate protective equipment and procedures.

### 4.2 Safety Precautions

---

The following precautions are suggestions and reminders of commonly recognized safe practices as well as specific hazards to be avoided and are not implied to be sufficient enough to ensure the safety of untrained personnel in all circumstances. Neither is this manual a substitute for technical manuals covering the equipment being measured. Always refer to the equipment manual and its spe-

cific warnings and instructions and observe them as well as those contained herein.

- a. The Instrument should only be used by personnel qualified to recognize shock hazards and who are trained in the safety precautions required to avoid possible injury.
- b. Do not connect any terminal of this Instrument to a circuit point at which a voltage exceeding 1000V AC or DC may exist with respect to earth ground. (Refer to Table 1-1, item 16.)
- c. Turn off power and discharge all capacitors in the circuit to be measured before connecting to or disconnecting from it.
- d. Before using this Instrument, check accessories (if any) and check test leads for missing, damaged, deteriorated or otherwise faulty insulating parts. Do not use, or permit the use of, equipment with faulty insulation until it has been properly repaired.
- e. Always wear safety glasses when working in electrical circuitry.
- f. Do not work alone on high voltage circuits. Make certain that someone capable of giving aid is watching nearby.
- g. Do not handle the Instrument, its test leads, or the circuitry while high voltage is being applied.
- h. Hands, shoes, floor, and workbench must be dry. Avoid making measurements under humid, damp, or other environmental conditions that could effect the dielectric withstanding voltage of the test leads or the Instrument.
- i. Do not change switch settings or test lead connections while the circuit is energized. A mistake could damage the Instrument and cause personal injury.
- j. Locate all voltage sources and accessible current paths before making connections to circuitry.



Dangerously high voltages may appear unexpectedly or in unexpected locations in faulty equipment. An open bleeder resistor, for example, may result in a capacitor retaining a dangerous charge.

- k. Make certain that the equipment being worked on is properly grounded and fuses are of the proper type and rating.
- l. Double-check switch positions and jack connections before applying power to the Instrument.
- m. Remain alert for low voltage circuits which may be floating at high voltage with respect to earth ground and for composite voltages (AC + DC) as found in r-f amplifiers. The floating voltage or composite voltage must not exceed the Instrument's rated maximum circuit-to-ground voltage.
- n. Do not make electrical measurements where the air may contain explosive concentrations of gas or dust, such as in mines, grain elevators, gasoline stations or in the presence of charging batteries until determined to be safe by qualified personnel. Note that even metallic dusts can be explosive.
- o. No General Purpose VOM is to be used to make electrical measurements on blasting circuits or blasting caps.

### 4.3 Polarity Reversing

---

The function switch provides a convenient means to reverse polarity of the internal battery to facilitate testing semiconductor devices. The +DC and -DC positions transpose internal connections to the COMMON and +jacks and therefore can also be used to reverse polarity of external voltages and currents connected to these jacks (only). Because polarity reversing momentarily interrupts the circuit, it should not be done while measuring current or voltage without first turning off the circuit power. When making measurements on the 50 $\mu$ A/250mV or 10A range, polarity can be corrected only by reversing the test leads.

### 4.4 Measurement of Unknown Voltage or Current

---

Sometimes the approximate voltage or current to be measured is known and the correct range may easily be selected. Often however, particularly when working upon faulty equipment, the voltage or current is unknown or may be much higher than normal or anticipated. When working upon unfamiliar or unknown equipment, always begin a measurement using the highest range available on the Instrument. Once it is determined that the voltage is within the limits of a lower range, change to the lower range.

### 4.5 Test Leads

---

These are provided with accessory screw-on alligator clips which may be attached to the probe tips. As well as eliminating the need to hand-hold test prods to a circuit for extended periods, the test clips reduce hand proximity to a high voltage circuit while energized. Circuit power must be turned off and any charged capacitors discharged before connecting or disconnecting clips to or from the current.

### 4.6 DC Voltage Measurement

---



Before measuring voltage, review the SAFETY PRECAUTIONS listed in paragraph 4.2. Also, when using the 260 as a millivoltmeter, care must be taken to prevent damage to the indication instrument from excessive voltage. Before using the 250 millivolt range, use the 2.5V DC range to determine that the voltage measured is not greater than 250mV (or .25V DC).

#### 4.6.1 DC Voltage Measurement 0-250 mV Range

- a. Set the function switch at +DC (Figure 4-1).
- b. Plug the black test lead in the -COMMON jack and the red test lead into the +50  $\mu$ Amps/250mV/10A jack.
- c. Set the range switch at 50  $\mu$ Amps (COMMON) position with 50V.
- d. Connect the black test lead to the negative side of the circuit being measured and the red test lead to the positive side of the circuit.
- e. Read the voltage on the black scale marked DC and use the figures marked 0-250. Read directly in millivolts.

**NOTE:** For polarity reversing see paragraph 4.3



#### 4.6.2 DC Voltage Measurement 0-2.5 Through 0.250V Range

- Set the function switch at +DC (Figure 4-1).
- Plug the black test lead into the -COMMON jack and the red test lead into the +jack.
- Set the range switch at one of the five voltage range positions marked 2.5V, 10V, 25V, 50V, or 250V.



When in doubt as to the highest voltage present, always use the highest voltage range as a protection to the Instrument. If the voltage is within a lower range, the switch may be set for the lower range to obtain a more accurate reading. Be sure power is off in the circuit being measured and all capacitors discharged.

- Connect the black test lead to the negative side of the circuit being measured and the red test lead to the positive side of the circuit.
- Turn on the power in the circuit being measured.
- Read the voltage on the black scale marked DC. For the 2.5V range, use the 0-250 figures and divide by 100. For the 10V, 50V, and 250V ranges, read the figures directly. For the 25V range, use the 0-250 figures and divide by 10.
- Turn off power to the circuit and wait until the meter indicates zero before disconnecting the test leads.

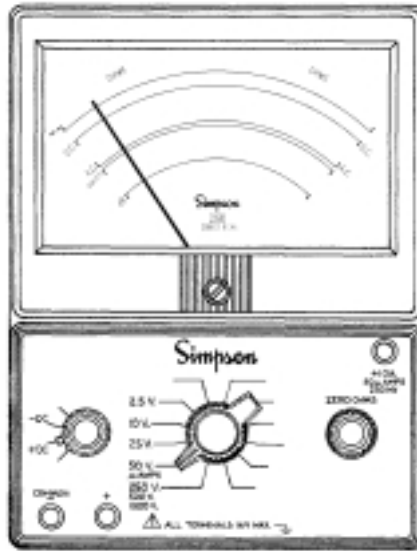

Figure 4-1. Jacks and Switch Positions for Measuring DC Voltages, 0-250V Ranges

#### 4.6.3 DC Voltage Measurement 0-500V Range



Use extreme care when working with high voltage circuits. Do not touch the Instrument or test leads while power is on in the circuit being measured. Before proceeding with the following steps, review the Safety Precautions in Paragraph 4.2.

- Set the function switch at +DC (Figure 4-2).
- Set the range switch at the 250V/500V/1000V position.
- Plug the black test lead into the -COMMON jack and the red test lead into the 500V jack
- Be sure power is off in the circuit being measured and all capacitors discharged. Connect the black test lead to the negative side of the circuit being measured and the red test lead to the positive side of the circuit.

- e. Turn on power in circuit being measured.
- f. Read the voltage using the 0-50 figures on the black scale marked DC. Multiply the reading by 10.
- g. Turn off power to the circuit and wait until the meter indicates zero before disconnecting the test leads.

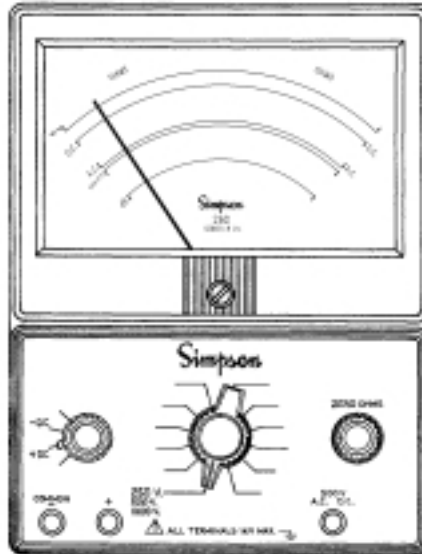

Figure 4-2. Jacks and Switch Positions for Measuring DC Voltage, 0-250 Ranges

#### 4.6.4 DC Voltage Measurement 0-1000V Range



Use extreme care when working with high voltage circuits. Do not touch the Instrument or test leads while power is on in the circuit being measured. Before proceeding with the following steps, review the Safety Precautions in Paragraph 4.2.

- a. Set the function switch at +DC (Figure 4-3).
- b. Set the range switch at the 250V/500V/1000V position.
- c. Plug the black test lead into the -COMMON jack and the red test lead into the 1000V jack.
- d. Be sure power is off in the circuit being measured and all capacitors discharged. Connect the black test lead to the negative side of the circuit being measured and the red test lead to the positive side of the circuit.
- e. Turn on power in circuit being measured.
- f. Read the voltage using the 0-10 figures on the black scale marked DC. Multiply the reading by 100.
- g. Turn off power to the circuit and wait until the meter indicates zero before disconnecting the test leads.

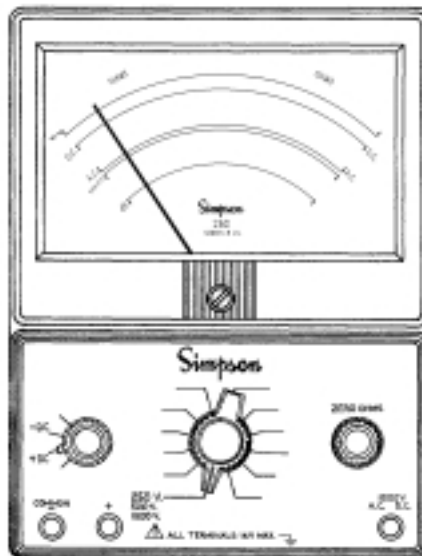

Figure 4-3. Jacks and Switch Positions for Measuring DC Voltage, 1000V Range

## 4.7 AC Voltage Measurement



Branch and distribution circuits (120/240/480V etc.) can deliver dangerous explosive power momentarily into a short circuit before the fuse/breaker opens the circuit. Make certain that the instrument switches are set properly, jacks are connected properly, and that the circuit power is turned off before making connections to such circuits. (Refer to Paragraph 4.7-d.)

The 260 responds to the average value of an AC waveform. It is calibrated in terms of the RMS value of a pure sine wave. If the waveform is nonsinusoidal and depending on its waveform, the reading may be either higher or lower than the true RMS value of the measured voltage. Therefore an error may occur if the 260 is used to measure a nonsinusoidal waveform. Also, accuracy is lessened at higher input frequencies. (Figure 4-4.)

Before proceeding with the following steps, review the Safety Precautions in Paragraph 4.2.

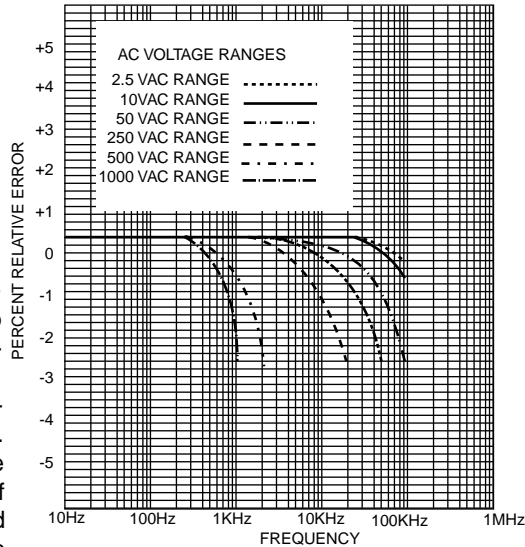

Figure 4-4. Frequency Response, AC Voltage ranges

### 4.7.1 AC Voltage Measurement 0-2.5 Through 0-250V Range

- a. Set the function switch at AC Volts Only position.

**NOTE:** The meter will not indicate if the switch is incorrectly set to a DC position.

- b. Set the range switch at one of the five voltage range positions marked 2.5V, 10V, 25V, 50V or 250V. (When in doubt as to actual voltage present, always use the highest voltage range as a protection to the Instrument. If the voltage is within a lower range, the switch may be set for

Figure 4-5. Jacks and Switch positions for measuring AC Voltages, 0-2.5 through 0-250V Ranges

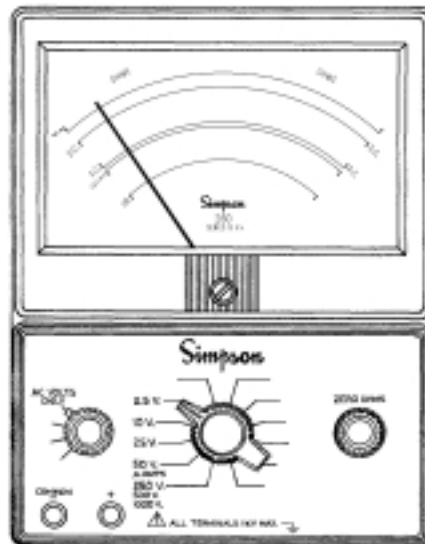

- the lower range to obtain a more accurate reading.)
- Plug the black test lead into the -COMMON jack and the red test lead into the +jack.
  - Turn off power to the circuit being measured and discharge all capacitors.
  - Connect the test leads across the circuit voltage to be measured with the black lead to the grounded side.
  - For the 2.5V range read the value directly on the scale marked 2.5 VAC. For the 10V, 25V, 50V and 250V ranges, read the red scale marked AC and use the black figure immediately above the scale.

#### 4.7.2 AC Voltage Measurement 0-500V Range



Do not attempt any voltage measurement which may exceed 1000 volts or the circuit-to-ground voltage of the instrument, 1000 volts maximum.

Be sure that the range switch is set to the 250V/500V/1000V range, function switch to AC Volts Only position, and the test leads connected to COMMON and 500V jack.

Do not touch the Instrument or test leads while the power is on the circuit being measured.

Use extreme care when working in high voltage circuits. Do not handle the Instrument or test leads while the circuit being measured is energized. Review all Safety Precautions in paragraph 4.2 and in the instruction manual for equipment being tested.

- Set the function switch at AC Volts Only position.



When making AC voltage measurements with the function switch incorrectly set to DC, the Instrument pointer will remain at or near zero, indicating a false “no voltage present” condition that could be hazardous.

- Set the range switch at 250V/500V/1000V position.
- Plug the black test lead into the -COMMON jack and the red test lead into the 500V jack.
- Be sure the power is off in the circuit being measured and that all capacitors have been discharged.
- Connect the test leads across the circuit voltage to be measured with the black lead to the grounded side, if any.
- Turn on power in the circuit being measured.
- Read the voltage on the red scale marked AC. Use the 0-50 figures and multiply by 10.

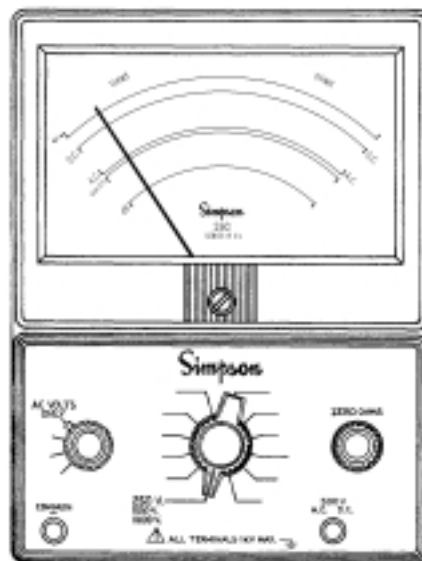

Figure 4-6. Jacks and Switch Positions for Measuring AC Voltage, 0-500V Range

### 4.7.3 AC Voltage Measurement 0-1000 Range



Use extreme care when working in high voltage circuits. Do not handle the Instrument or test leads while the circuit being measured is energized. OBSERVE ALL SAFETY PRECAUTIONS in paragraph 4.2 and in the instruction manual for the equipment being tested.

Do not attempt any voltage measurement which may exceed 1000V or the circuit-to-ground voltage of the instrument, 1000V max.

Be sure that the range switch is set to the 250V/500V/1000V range, function switch to AC Volts Only position, and test leads connected to COMMON and 1000V jack.

Do not touch the instrument or test leads while the power is on in the circuit being measured.

- a. Set the function switch at AC.
- b. Set the range switch at 250V/500V/1000V position.
- c. Plug the black test led into the -COMMON jack and the red test lead in the 1000V jack.
- d. Be sure the power is off in the circuit being measured and that all capacitors are discharged.
- e. Connect the test leads across the circuit voltage to be measured with the black lead to the grounded side.
- f. Turn on the power in the circuit being measured.
- g. Read the voltage on the red scale marked AC. Use the 0-10 figures and multiply by 100.

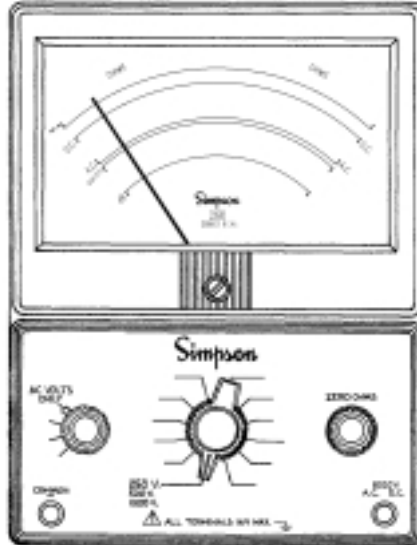

Figure 4-7. Jacks and Switch Positions for Measuring AC Voltage, 0-1000V Range

## 4.7 Output Voltage Measurement

The following steps instruct how to measure the AC component of an Output Voltage where both AC and DC voltage levels exist. This occurs primarily in amplifier circuits. A 0.1 mfd, 400V capacitor in series with the OUTPUT jack blocks the DC component of the current in the test circuit but allows the AC or desired component to pass on to the indicating instrument circuit. The blocking capacitor may alter the AC response at low frequencies but is usually ignored at audio frequencies (Figure 4-8).



Do not connect the OUTPUT jack to a circuit in which the DC voltage component exceeds 350V.

Before proceeding with the following steps, review the Safety Precautions in Paragraph 4.2.

Figure 4-8. Frequency Response Output Ranges

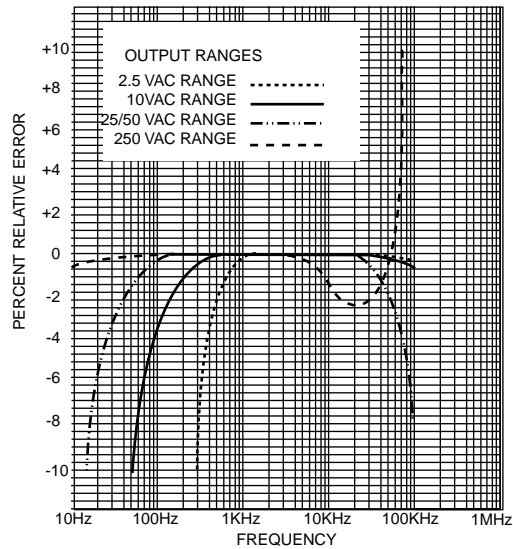

- Set the function switch at AC Volts Only position (Figure 4-9).
- Plug the black test lead into the -COMMON jack and the red test lead into the OUTPUT jack.
- Set the range switch at one of the range positions marked 2.5V, 10V, 25V, 50V, or 250V.
- Connect the test leads across the circuit being measured with the black test lead to the grounded side.
- Turn on the power in the test circuit. Read the output voltage on the appropriate AC voltage scale. For the 0-2.5V range, read the value directly on the scale marked 2.5 VAC. For the 10V, 25V, 50V, or 250V ranges, use the red scale marked AC and read the black figures immediately above the scale.

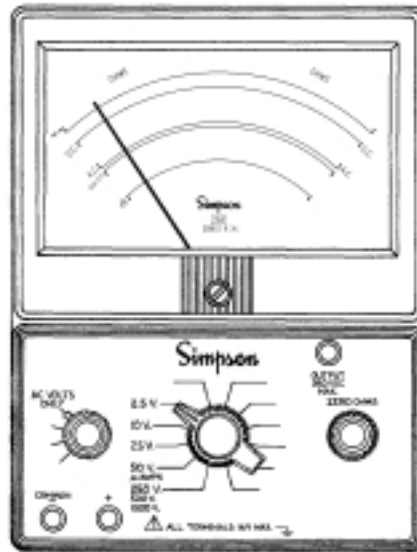

Figure 4-9. Jacks and Switch Positions for Output Measurements

#### 4.8 Decibel Measurement (-20 to +50 dB)

Certain industries measure in terms of voltage or current ratios (decibels) based on a specific reference level. The dB scale on the 260 serves this purpose and is calibrated to a reference level (zero dB) of 0.001W into 600Ω. The scale calibration of -20 to +10 dB is for the 0-2.5V range (zero dB = 0.775V). Higher ranges may be used by adding an appropriate dB value to the reading in accordance with the chart below. Before proceeding with the following steps review the Safety Precautions in Paragraph 4.2

- a. Refer to Figure 4-10 for switch settings and jack connections
- b. Use operating instructions for AC VOLTAGE MEASUREMENT, 0-2.5V/10/25V/50V/250V RANGES (Paragraph 4.10).

**NOTE:** Do not use the 500V or 1000V ranges for decibel readings.

- c. Read decibels on the bottom scale marked dB. For the 10V/25V/50V/250V ranges, add the appropriate factor from the chart below:

VoltageRange	dB Range	Reading
0-2.5V	-20 to +10	read directly
0-10V	-8 to +22	add +12 dB to reading
0-25V	0 to 30	add +20 dB to reading
0-50V	+6 to +36	add 26 dB to reading
0-250V	+20 to +50	add 40 dB to reading

**NOTE:** The maximum voltage ratio that can be measured is +50 dB on the 0-250V range.

- d. If dB measurements are being made to a 0.006W into 500Ω reference level, subtract +7 dB from the reading obtained.

Figure 4-10. Jacks and Switch Positions for Measuring Decibels

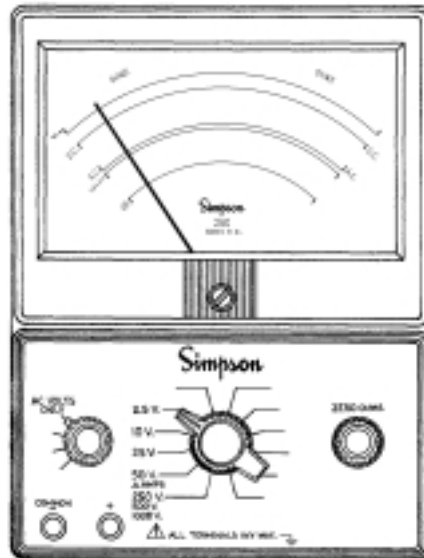

## 4.9 Direct Current Measurement



Do not change the range setting of the range or function switches while the circuit is energized.

Never disconnect test leads from the circuit under measurement while it is energized.

Always turn the power off and discharge all the capacitors before changing the

switch settings, or disconnecting the leads.

Never exceed the circuit-to-ground voltage of the instrument (1000V Max., Table 1-1. Item 16).

Always connect the instrument in series with the ground side of the circuit.

In all direct current measurements, make certain the power to the circuit being tested has been turned off before connecting and disconnecting test leads or restoring circuit continuity.

#### 4.9.1 Direct Current Measurement 0-50 $\mu$ A Range

- Set the functions switch at +DC
- Plug the black test lead into the -COMMON jack and the red test lead into the +50 $\mu$ AMPS/250mV jack.
- Set the range switch at 50 $\mu$ AMPS (dual position with 50V).
- Open the grounded side of the circuit in which the current is being measured. Connect the VOM in series with the circuit. Connect the red test lead to the positive side and the black test lead to the negative side.
- Read the current on the black DC scale. Use the 0-50 figures to read directly in microamperes.

**NOTE:** For polarity reversing see paragraph 4.3.

#### 4.9.2 Direct Current Measurement 0-1mA through 0-500mA Range

- Set the function switch at +DC (Figure 4-11).
- Plug the black test lead into the -COMMON jack and the red test lead into the +jack.
- Set the range switch at one of the four range positions marked 1 mA, 10 mA, 100 mA or 500 mA.
- Open the grounded side of the circuit in which the current is being measured. Connect the VOM in series with the circuit. Connect the red test lead to the positive side and the black test lead to the negative side.
- Turn the power on. Read the current in milliamperes on the black DC scale. For the 1 mA range, use the 0-10 figures and divide by 10. For the 10 mA range, use the 0-10 figures directly. For the 100mA range, use the 0-10 figures and multiply by 10. For the 500 mA range, use the 0-50 figures and multiply by 10.
- Turn the power off and disconnect the test leads.

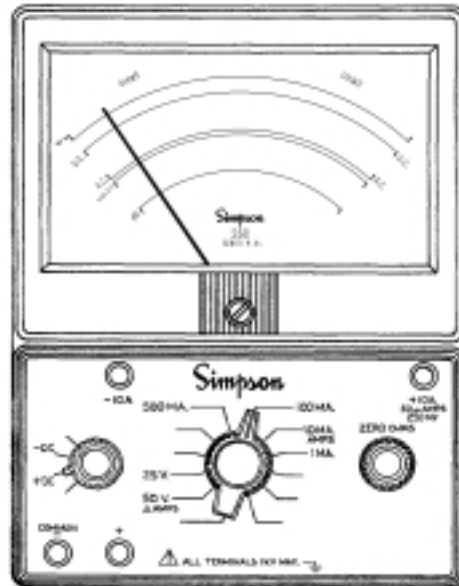

Figure 4-11. Jacks and Switch Positions for Measuring Direct Current





This range is only intended for measurements in low voltage circuits (under 25V DC) such as the primary power in vehicles or their accessories.

#### 4.9.3 Direct Current Measurement 0-10A Range

- a. Plug the black test lead into the -10A jack and the red test lead into the +10A jack.
- b. Set the range switch at 10 AMPS (dual position with 10 mA).
- c. Open the grounded side of the circuit in which the current is being measured. Connect the VOM series with the circuit, connecting the red test lead to the positive side and the black test lead to the negative side.

**NOTE:** The function switch has no effect on polarity for the 10 AMPS range.

- d. Turn the power on. Read the current directly on the black DC scale. Use the 0-10 figures to read directly in amperes.
- e. Turn the power off and disconnect the test leads.



The 10A range is not internally fused in the 260.

When using the 10A range, never disconnect a test lead from a jack or from the circuit while the circuit is energized. Doing so may damage the test jacks or leads and the arcing may be hazardous to the operator. Turn off circuit power and wait for meter reading to drop to zero.

The polarity reversing feature of the function switch does not operate on the 0-10A range. If polarity is incorrect, turn off circuit power, wait for the meter indicator to reach zero, and then interchange test lead connections to the circuit.

### 4.10 Zero Ohms Adjustment

---



Voltage applied to a resistance range will cause reading errors if low and damage to the Instrument if high. When making in-circuit measurements, make certain that the circuit is completely de-energized before making connections to it.

When making in-circuit measurements, circuit paths in parallel with the resistance being measured may cause reading errors. Check circuit diagrams for the presence of such components before assuming that the reading obtained is correct.

When resistance is measured, the INTERNAL batteries B1 and B2 furnish power for the circuit. Since batteries are subject to variation in voltage and internal resistance, the Instrument must be adjusted to zero before measuring a resistance, as follows:

- a. Turn range switch to desired ohms range.
- b. Plug the black test lead into the -COMMON jack and the red test lead into the + jack.
- c. Connect the ends of test leads together to short the VOM resistance circuit.

- d. Rotate the ZERO OHMS control until pointer indicates zero ohms. If pointer cannot be adjusted to zero, one or both of the batteries must be replaced. (For battery replacement, refer to Section 5.)
- e. Disconnect shorted test leads.

#### 4.11 Measuring Resistance

---

- a. Before measuring resistance in a circuit, make sure the power is off to the circuit being tested and all capacitors are discharged. Disconnect shunting components from the circuit before measuring its resistance.
- b. Set the range switch to one of the resistance range positions (Figure 4-12) as follows:
  1. Use R X 1 for resistance readings from 0-200Ω.
  2. Use R X 100 for resistance readings from 200 to 20,000Ω.
  3. Use R X 10,000 for resistance readings above 20,000Ω.
- c. Set the function switch at either -DC or +DC position. The results are the same in either position unless there are semiconductors in the circuit. (See paragraph 4.12) Adjust ZERO OHMS control for each resistance range.
- d. Observe the reading on the OHMS scale at the top of the dial.

*Figure 4-12. Jacks and Switch Positions for Measuring Resistance*

**NOTE:** The OHMS scale reads from right to left for increasing values of resistance.

- e. To determine the actual resistance value, multiply the reading by the factor at the switch position. (K on the OHMS scale equals one thousand.)

#### 4.12 Resistance Measurement of Semiconductors

---



Make sure that the OHMS range being used will not damage any of the semiconductors (refer to table 1-1, item 8).

If there is a “forward” and “backward” resistance such as in diodes, the resistance should be relatively low in one direction (for forward polarity) and higher in the opposite direction.

Rotate the function switch between the two DC positions to reverse polarity. This will determine if there is a difference between the resistance in the two directions. To check a semiconductor in or out of a circuit (forward and reverse bias resis-

tance measurements) consider the following before making measurement:

- a. The polarity of the battery voltage will be as marked at the jacks when the switch is in the +DC position and reversed in the -DC position.
- b. Ensure that the range selected will not damage the semiconductor. (Refer to Table 1-1, item 8, and review the specification limits of the semiconductor according to the manufacturer's ratings.)
- c. If the semiconductor is a silicon diode or conventional silicon transistor, no precautions are normally required.
- d. If the semiconductor material is germanium, check the ratings of the device and refer to Table 1-1, Item 8.

**NOTE:** The resistance of diodes will measure differently from one resistance range to another on the VOM with the function switch in a given position. For example, a diode which measures 80 ohms on the R X 1 range may measure 300 ohms on the R X 100 range. The difference in values is a result of the diode characteristics and is not indicative of any fault in the VOM.

### 4.13 Continuity Tests



Turn off all power to the circuit under test before proceeding any further.

- a. Set the FUNCTION switch to the “Ω.” Insert the black test lead into the COMMON (-) and the red test lead into the (+) jacks, (Figure 4-13).
- b. Touching the test lead probe tips together should produce sound.
- c. To test for continuity, probe the circuit or component in question. An audible sound indicates continuity.
- d. The higher the circuit's resistance, the lower the sound level. The lower the circuit's resistance, the higher the sound level.
- e. Refer to paragraph 4.20, Figure 4-12, for measurements of circuit resistance, if any, that exists.

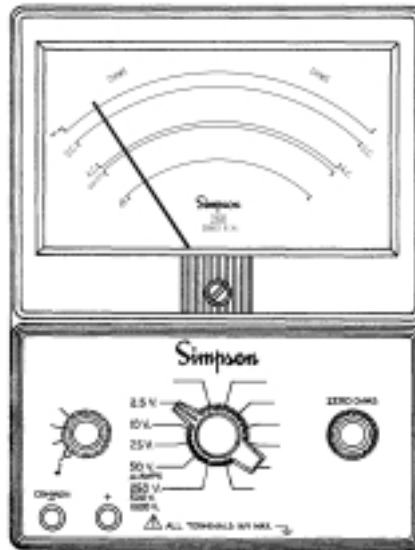

Figure 4-13. Jacks and Switch Positions for Continuity Tests

## 5 OPERATOR SERVICING

---

This Instrument has been carefully designed and constructed with high-quality components. By providing reasonable care and following the instructions in this manual, the user can expect a long service life of the Instrument.



Prior to opening the battery compartment cover, disconnect the test leads from live circuits.

### 5.1 Battery and Fuse Replacement

---

1. The batteries and 1 Amp fuse are located inside an isolated compartment at the top-rear of the Instrument case. Open the compartment as follows:
  - a. Place the Instrument face down on a soft padded surface.
  - b. Unscrew the single screw on the cover.
  - c. Remove the cover from the case and set aside. Batteries and fuse can now be replaced.

**NOTE:** If replacement of the 2 AMP high current interrupting fuse is necessary, the instrument case must be removed (see paragraph 5.3).

Battery replacement is necessary whenever the instrument cannot be adjusted to infinity ( $\infty$ ) with open test leads on the Lower Power Ohmmeter ranges or with shorted test leads on the conventional ohmmeter ranges. If these adjustments cannot be made, replace the 1.5V, D size cell. If the ohms adjustment cannot be made on the RX 10K range, replace the 9V battery.

2. Replace the D size cell as follows:
  - a. Remove the D size cell.
  - b. Grasp the battery at the center and pull directly up.
  - c. Insert the new cell, (-) end first while pushing against the (-) terminal spring clip.
  - d. Gently push the (+) side of the cell into place.
3. To remove the 9V battery:
  - a. Remove the battery with the mating connector from the compartment.
  - b. Take the connector off the old battery and connect it to the new battery.
  - c. Insert new battery into the compartment.
  - d. Place the connector leads so they rest between the cavity walls and clear the fuse terminals. The extended leads are placed between the battery holder and the top wall of the case.

**NOTE:** One ampere and two ampere fuse replacement is necessary when there is no meter deflection on any of the DC, AC Volts or Ohms ranges but the DC Amps range operates properly.

4. Replace the 1 Amp fuse is as follows:
  - a. Pull the defective fuse from its retaining spring clips.
  - b. Snap in the replacement fuse and replace cover.

**NOTE:** A spare fuse is located in a cavity next to the fuse clip. Use only if proper replacement is not available; save the internal spare for an emergency.

## 5.2 Fuse Protection

---

A 1 Amp 250V quick-acting fuse and a 2A high voltage, high interruption capacity fuse is connected in series with the input circuit as additional protection to the VOM against excessive energy fault current, such as a power line overload.

It is important to replace the 1 Amp fuse with a Littlefuse Type 312001 only to prevent the 2 Amp high interruption capacity fuse from opening on a nominally high overload.

If the Instrument fails to indicate, the 1 Amp or 2 Amp fuses may be burned out. (Refer to Paragraph 5.2 for fuse replacement.) A 1 Amp spare fuse is furnished with each instrument. (Both 1 Amp fuses are located in the battery and fuse compartment.) The 2 Amp fuse is located on the instrument panel under the printed circuit board.

## 5.3 Care

---



- a. Do not attempt to clean this instrument with test leads connected to a power source.
- b. Immediately clean all spilled materials from the instrument and wipe dry. If necessary, moisten a cloth with soap and water to clean plastic surfaces.
- c. Do not allow the battery to fully discharge. When the batteries reach the end of their useful life, they should be replaced promptly. Failure to do so may result in corrosion at the battery contacts due to battery leakage.
- d. Whenever possible, avoid prolonged exposure or usage in areas which are subject to temperature and humidity extremes, vibration, mechanical shock, dust, corrosive fumes, or strong electrical or electromagnetic interferences.
- e. Monthly care: Verify Instrument accuracy by performing operational checks using known, accurate, stable sources. If proper calibration equipment is not available, contact the nearest Authorized Service Center. (If the Instrument has not been used for 30 days, check the batteries for leakage and replace if necessary.)
- f. Annual Care: It is recommended that the Instrument be returned annually to the nearest Authorized Service Center, or the factory, for an overall check, adjustment, and calibration.
- g. Storage: When the Instrument is not in use, store it in a room free from temperature extremes, dust, corrosive fumes, and mechanical vibration or shock. If storage time is expected to exceed 30 days, remove batteries.

## 6 PARTS LIST AND SCHEMATIC DIAGRAM

---

This Instrument must be serviced by qualified personnel. To aid in troubleshooting a schematic diagram is shown on page 32. The replacement parts list (Table 6-1) describes the components and refers to Simpson part numbers. Reference Symbol numbers correlate the components shown on the schematic diagram with the parts list.



Improper or makeshift repairs and/or parts substitutions may be dangerous to the next user. Replacement parts must have mechanical and electrical characteristics identical to the original parts.

The following information is provided as an adjunct to the overall text contained in this manual and should be read and understood thoroughly before ordering replacement parts for the instrument.

### 6.1 Removing the Instrument Case.

---

To gain access to the inside of the Instrument panel disconnect the test leads and remove the cover from the battery compartment. Remove the four case- fastening screws, and lift the case from the panel.

When replacing the case, make certain that the wires leading to the battery compartment are seated in their respective slots within the compartment wall. This will prevent damage to the wire insulation.

### 6.2 Replacement Parts and Schematic Diagram

---

To obtain replacement parts, address order to the nearest Authorized Service Center. Refer to paragraph 2.3.1 for ordering instructions.

*Table 6-1. Replacement Parts*

Reference Symbol	Description	Part Number
R1	Rheostat, 150 k $\Omega$	6-111487
R1A	Resistor, 20 k $\Omega$	5-119705
R2, R22	Rheostat, 3 k $\Omega$	6-111488
R25	Rheostat, 3 k $\Omega$	6-111488
R2A	Resistor, 2.2 k $\Omega$	5-118606
R3	Resistor, .025 $\Omega$	6-111575
R4	Resistor, 45 k $\Omega$	1-114192
R5	Resistor, 150 k $\Omega$	1-113366
R6	Resistor, 300 k $\Omega$	5-116808
R7	Resistor, 500 k $\Omega$	1-114090
R8	Resistor, 4 M $\Omega$	1-113362
R9	Resistor, 11.25 M $\Omega$	6-114332
R9A	Resistor, 3.75 M $\Omega$	6-114331
R10	Resistor, 3.75M $\Omega$	1-115765
R10A	Resistor, 1.25 M $\Omega$	6-114333

Reference Symbol	Description	Part Number
R11	Resistor, 15 k $\Omega$	1-113347
R12	Resistor, 0.48 $\Omega$ , 5W (wire wound)	6-114537
R13	Resistor 2 $\Omega$ , 5W (wire wound)	5-115271
R14	Resistor, 22.5 $\Omega$ V, 3W (wire wound)	5-110194
R15	Resistor, 238 $\Omega$	1-115897
R16	Resistor, 11 $\Omega$ , 5W (wire wound)	5-119567
R17	Resistor, 1.095 k $\Omega$	6-111572
R18	Resistor, 138 $\Omega$	6-111573
R19	Resistor, 17.320 k $\Omega$	6-111570
R20	Resistor, 113.860 k $\Omega$	6-111571
R21	Potentiometer, 11.25 k $\Omega$	6-111446
R23, R24	Resistor, 4 k $\Omega$	5-114835
R26	Resistor, 7.5 k $\Omega$	1-113370
R27	Resistor, 37.5 k $\Omega$	1-113393
R28	Resistor, 75 k $\Omega$	5-116921
R29	Resistor, 125 k $\Omega$	6-114330
R30	Resistor, 1 M $\Omega$	1-113392
C1	Capacitor, 0.1 $\mu$ F, 400V	1-113733
D1, D2	Diode, Germanium	1-115970
F1	Fuse, 1A, 250V; 3AG (1-1/4" x 1/4") Quick acting (Littlefuse Type 312001)	1-112507
F2	Fuse, 2A, 600V, Littlefuse Type BLS or 2A, 500V, Bussman Type BBS. For Function Switch	1-115789
	Knobs:	
	For Zero Ohms Adjust	1-115790
	For Range Switch	10-864352
	Case Assembly, Complete (Including Handle less Battery Compartment Cover)	10-865886
	Battery Compartment Cover Assembly	10-560357
	Cover Assembly for indicating Instrument	10-560288
	Probe Tip Leads, 1 red & 1 black	00125
	Audio Transducer	6-114337

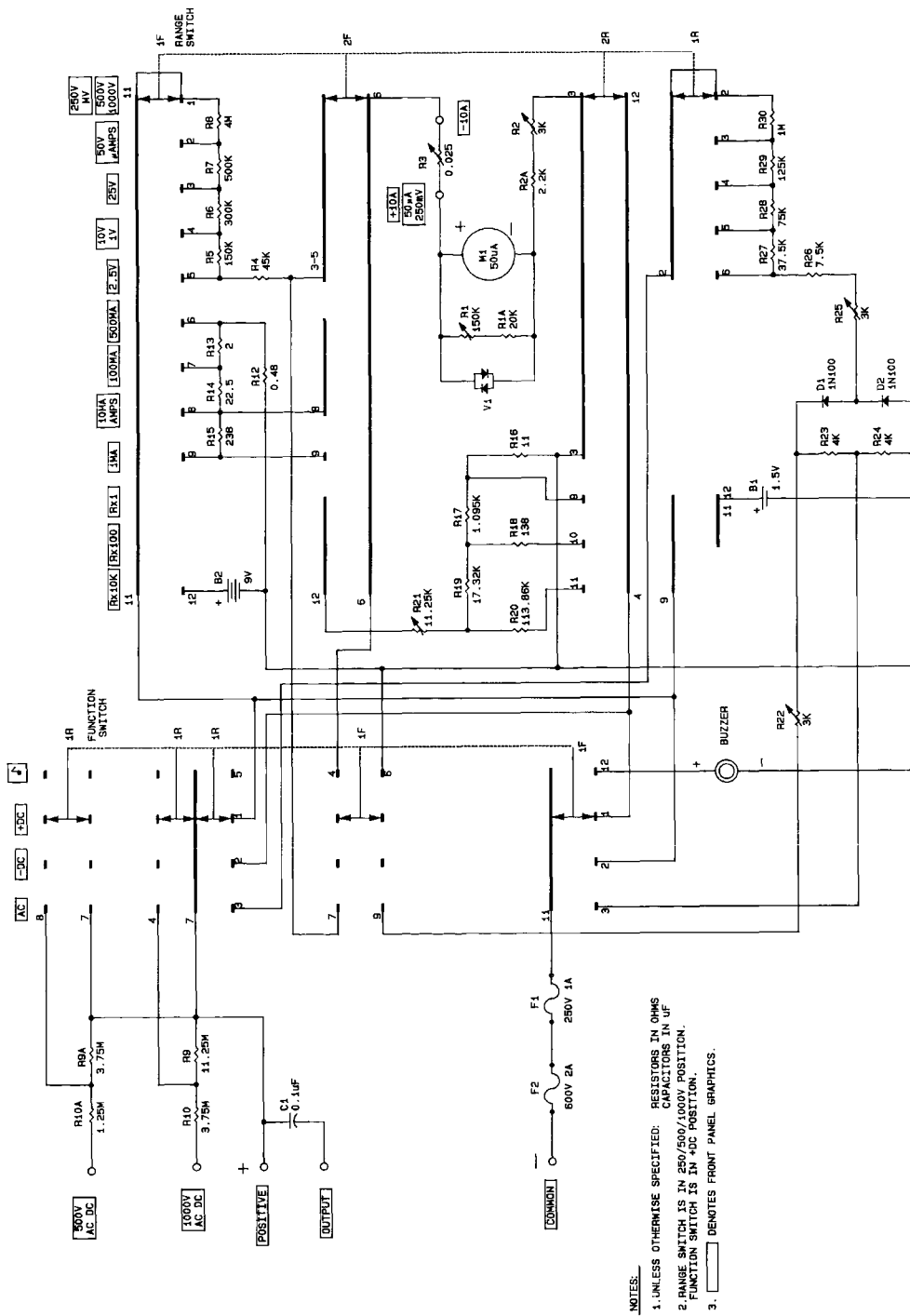

Figure 6-1. Schematic Diagram, Model 260-8XI



**NOTES:**

**NOTES:**

**NOTES:**

**SIMPSON ELECTRIC COMPANY** 853 Dundee Avenue  
Elgin, IL 60120-3090 (847) 697-2260 FAX (847) 697-2272  
Printed in U.S.A. Part No. 06-115021 Edition 5, 11/01  
Visit us on the web at: [www.simpsonelectric.com](http://www.simpsonelectric.com)