

M	CKT SIZE	①	②	③	④	⑤	DIMENSION 'A'	DIMENSION 'B'	DIMENSION 'C'	DIMENSION 'D'
		MAIN HOUSING	TPA	SIGNAL HOUSING	POWER TERMINAL	SIGNAL TERMINAL				
L	2P-12S	172510-3212	46708-3212	46709-0004	173693-****	70058-****	45.76	28.4	26.48	10.67
L	2P-18S	172510-3218	46708-3218	46709-0006	173693-****	70058-****	50.84	33.5	31.80	15.75
K	2P-24S	172510-3224	46708-3224	46709-0008	173693-****	70058-****	55.92	38.6	36.85	20.83
K	4P-12S	172510-3412	46708-3412	46709-0004	173693-****	70058-****	60.76	43.4	41.48	10.67
K	4P-18S	172510-3418	46708-3418	46709-0006	173693-****	70058-****	65.84	48.5	46.80	15.75
J	4P-24S	172510-3424	46708-3424	46709-0008	173693-****	70058-****	70.92	53.6	51.85	20.83
J	6P-12S	172510-3612	46708-3612	46709-0004	173693-****	70058-****	75.76	58.4	56.48	10.67
J	6P-18S	172510-3618	46708-3618	46709-0006	173693-****	70058-****	80.84	63.5	61.85	15.75
I	6P-24S	172510-3624	46708-3624	46709-0008	173693-****	70058-****	85.92	68.6	66.93	20.83

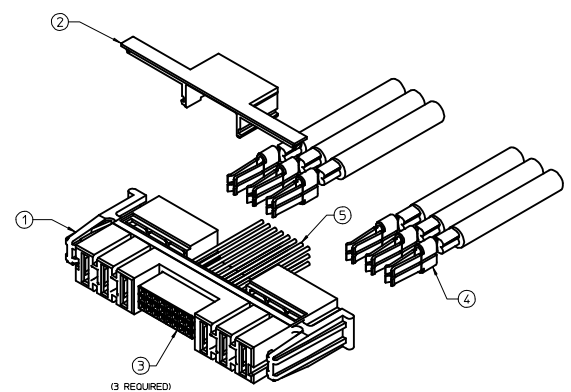

EXPLODED VIEW

MAIN HOUSING

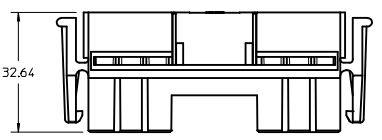

TPA

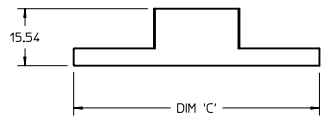

SIGNAL HOUSING

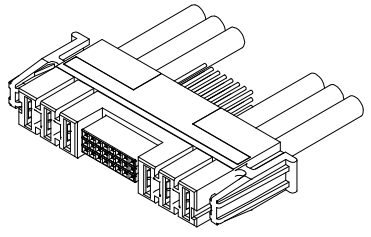
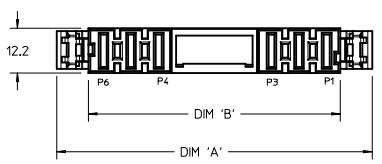
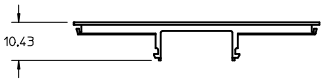
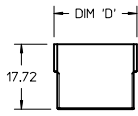

NOTES:

1. SEE CHART FOR MATERIAL DETAILS
2. PART MATES TO MOLEX PLUG SERIES 172453
3. ASSEMBLY SHOWN FOR REFERENCE ONLY. EACH ITEM HAS TO BE ORDERED SEPARATELY.
4. SEE SD-173693-001 FOR POWER TERMINAL DETAILS
5. SEE SD-70058-*** FOR SIGNAL TERMINAL DETAILS

CHG TRML P/N EEC NO: UCP2016-4071 DRAWN: JSCHAFFER 2016/04/18 CHKD: CHYD APPR: BPISZCZOR 2016/10/03	QUALITY SYMBOLS ▽=0 ▽=0 ▽=0	GENERAL TOLERANCES (UNLESS SPECIFIED) mm INCH		DIMENSION STYLE MM ONLY	SCALE 1.5:1	DESIGN UNITS METRIC	THIRD ANGLE PROJECTION
		4 PLACES ±--- ±--- 3 PLACES ±--- ±--- 2 PLACES ±0.13 ±--- 1 PLACE ±0.25 ±--- 0 PLACE ±--- ±---	DRAWN BY JSCHAFFER	DATE 2014/02/17	CHECKED BY DATE	APPROVED BY BPISZCZOR	DATE 2016/10/03
DRAFT WHERE APPLICABLE MUST REMAIN WITHIN DIMENSIONS		ANGULAR ±1/2°		MATERIAL NO. SEE CHART		DOCUMENT NO. SD-172510-001	SHEET NO. 1 OF 1

M	CKT SIZE	①	②	③	④	⑤	DIMENSION 'A'	DIMENSION 'B'	DIMENSION 'C'	DIMENSION 'D'
		MAIN HOUSING	TPA	SIGNAL HOUSING	POWER TERMINAL	SIGNAL TERMINAL				
L	2P-12S	172510-3212	46708-3212	46709-0004	173693-****	70058-****	45.76	28.4	26.48	10.67
L	2P-18S	172510-3218	46708-3218	46709-0006	173693-****	70058-****	50.84	33.5	31.80	15.75
K	2P-24S	172510-3224	46708-3224	46709-0008	173693-****	70058-****	55.92	38.6	36.85	20.83
K	4P-12S	172510-3412	46708-3412	46709-0004	173693-****	70058-****	60.76	43.4	41.48	10.67
K	4P-18S	172510-3418	46708-3418	46709-0006	173693-****	70058-****	65.84	48.5	46.80	15.75
J	4P-24S	172510-3424	46708-3424	46709-0008	173693-****	70058-****	70.92	53.6	51.85	20.83
J	6P-12S	172510-3612	46708-3612	46709-0004	173693-****	70058-****	75.76	58.4	56.48	10.67
J	6P-18S	172510-3618	46708-3618	46709-0006	173693-****	70058-****	80.84	63.5	61.85	15.75
I	6P-24S	172510-3624	46708-3624	46709-0008	173693-****	70058-****	85.92	68.6	66.93	20.83

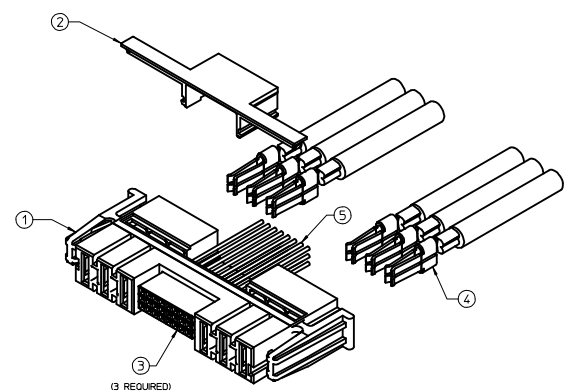

EXPLODED VIEW

MAIN HOUSING

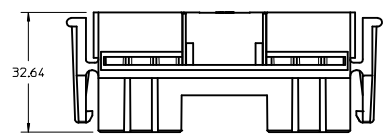

TPA

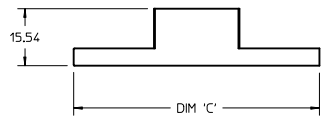

SIGNAL HOUSING

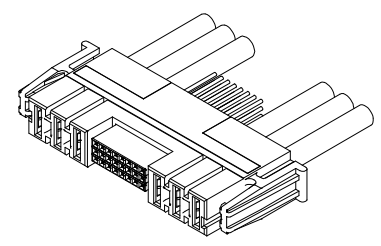
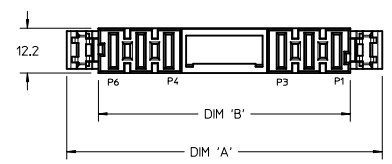
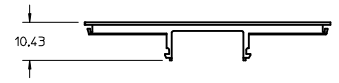
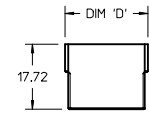

NOTES:

1. SEE CHART FOR MATERIAL DETAILS
2. PART MATES TO MOLEX PLUG SERIES 172453
3. ASSEMBLY SHOWN FOR REFERENCE ONLY. EACH ITEM HAS TO BE ORDERED SEPARATELY.
4. SEE SD-173693-001 FOR POWER TERMINAL DETAILS
5. SEE SD-70058-*** FOR SIGNAL TERMINAL DETAILS

CHG TRML P/N EEC NO: UCP2016-4071 DRAWN: JSCHAFFER 2016/04/18 CHKD: CHYD APPR: BPISZCZOR 2016/10/03	QUALITY SYMBOLS ▽=0 ▽=0 ▽=0	GENERAL TOLERANCES (UNLESS SPECIFIED)		DIMENSION STYLE MM ONLY		SCALE 1.5:1	DESIGN UNITS METRIC	THIRD ANGLE PROJECTION
		4 PLACES ±--- ±--- 3 PLACES ±--- ±--- 2 PLACES ±0.13 ±--- 1 PLACE ±0.25 ±--- 0 PLACE ±--- ±---	mm INCH	DRAWN BY JSCHAFFER	DATE 2014/02/17	CHECKED BY DATE	TITLE TEN60 WIRE TO BOARD POWER / SIGNAL MIX	MATERIAL NO. SD-172510-001
DRAFT WHERE APPLICABLE MUST REMAIN WITHIN DIMENSIONS		ANGULAR ±1/2°		SEE CHART		THIS DRAWING CONTAINS INFORMATION THAT IS PROPRIETARY TO MOLEX INCORPORATED AND SHOULD NOT BE USED WITHOUT WRITTEN PERMISSION		