

Terminals / W-Series

Overview / W-Series

D.2 - D.3

Feed-through terminals

Standard design D.4 - D.11
Compact design D.12 - D.17

PE terminals

Standard design D.18 - D.23
Compact design D.24 - D.27

Disconnect terminals

D.28 - D.31

Fuse terminals

D.32 - D.35

Installation terminals

Distribution terminals D.36 - D.39
Neutral disconnect terminals D.40 - D.43

Measuring-disconnecting terminals

D.44 - D.45

Pluggable terminals

Spade connection D.46 - D.47
Connector connection D.48 - D.49

Initiator and actuator terminals

D.50 - D.53

Mini terminals TS 15

D.54 - D.57

Terminals with spring loaded cable clamps

D.58 - D.61

Terminals for temperature measuring circuits

D.62

Terminals with electronic components

D.63 - D.67

Accessories / W-Series

Overview D.68 - D.69
Accessories D.70 - D.91

Terminals / SAK-Series

Information

D.92 - D.93

stud terminals

Overview / stud terminals

D.94 - D.97

stud terminals WF / WFF

1-stud terminals D.98 - D.101
2-stud terminals D.102 - D.103

stud terminals ST 4000

2-stud terminals D.104 - D.106

Overview

Screw connection

For a long time now, Weidmüller's screw mains terminals in the W-series have set the standard for functional perfection down to the very last detail. The combination of many advantages today remains unsurpassed and gives the W-series a unique lead on the market.

The W-series offers solutions for conductor cross-sections from 0.08 to 240 mm² and for all common electrical functions.

One unique feature is the pluggable cross-connector (ZQV) for most terminals with cross-sections 2.5 and 4 mm². It brings considerable time savings compared to all other screw terminals on the market.

Thanks to the patented design of Weidmüller's screw connection (tension clamp) it is possible for two conductors of the same cross-section to be connected in one and the same clamping point without difficulty.

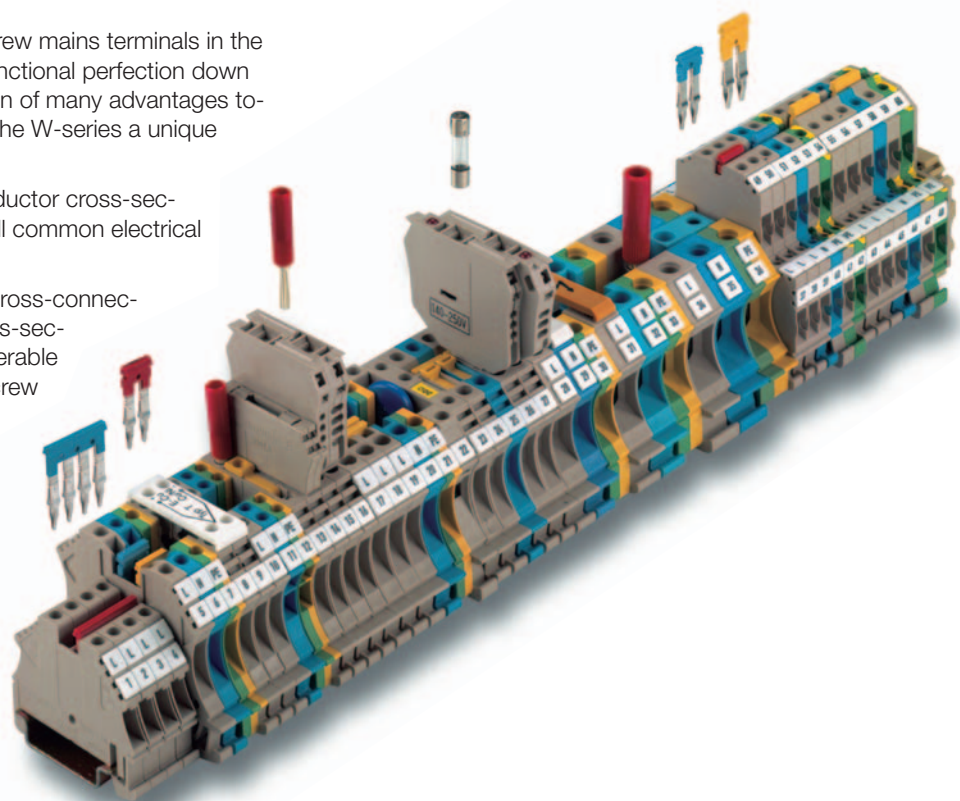

Design

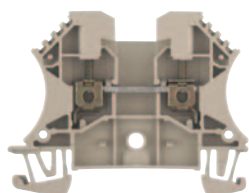

W-standard

- Same contour design from 2.5 to 10 mm²
- Conductor sizes from 0.8 to 240 mm²
- Large clamping capacity range

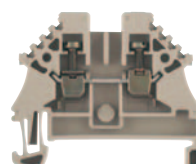

W-compact

- Smaller size
- Identified by an "N" in the type designation
- Conductor sizes from 0.08 to 150 mm²

Product overview

Rating cross-section	1.5 mm ²		2.5 mm ²		4 mm ²		6 mm ²		10 mm ²		16 mm ²		35 mm ²	
	standard	compact	standard	compact	standard	compact	standard	compact	standard	compact	standard	compact	standard	compact
Feed-through terminals														
2 connections	•	•	•	•	•	•	•		•		•	•	•	•
3 and 4 connections	•	•	•	•	•	•			•					
Protective earth terminals														
2 connections	•	•	•	•	•	•	•		•		•	•	•	•
3 and 4 connections	•		•	•	•	•		•	•					
Fuse terminals			•		•		•							
Isolating terminals	•		•		•									
Measuring and isolating terminals					•		•							
3-conductor installation terminals	•		•		•									
Isolating neutral terminals	•		•		•		•		•		•		•	
Pluggable terminals	•		•		•									
Initiator/actuator terminals	•		•		•									
Terminals with built-in components	•		•		•	•								
Miniature terminals TS 15	•													
Rating cross-section	50 mm ²		70 mm ²		95 mm ²		120 mm ²		150 mm ²		240 mm ²			
	standard	compact	standard	compact	standard	compact	standard	compact	standard	compact	standard	compact		
Feed-through terminals			•	•	•	•	•	•	•		•			
Protective earth terminals			•		•	•	•	•	•					
Isolating neutral terminals					•									

In detail

The connection

Separation of electrical and mechanical function:

- Clamping unit (tension clamp and clamping screw) of hardened steel for very high contact force
- Busbar of copper for low voltage loss. Tin-plated surface for minimum contact resistances



Cross-connections, also pluggable

- Screw-in or pluggable cross-connections
- For screw terminals, the pluggable cross-connection (ZQV) is unique, with considerable time savings
- Standard cross-connections for 2.5 and 4 mm² for up to 10 poles
- Pluggable cross-connections available for up to 50 poles for own assembly



Simple to use

- Snap on and off at right angles to the mounting rail in both directions
- Integrated idle point when loosening the terminal screws – specially important for mechanical screwdrivers
- Screwdriver guided by countersinking of clamping screws
- All parts captive in the terminal
- Many different options for labelling

Wemid insulating material

- Resistant to creep current CTI 600
- Temperature resistant to 120°C
- Combustibility class V0 to UL94
- Contains no halogen or phosphorous

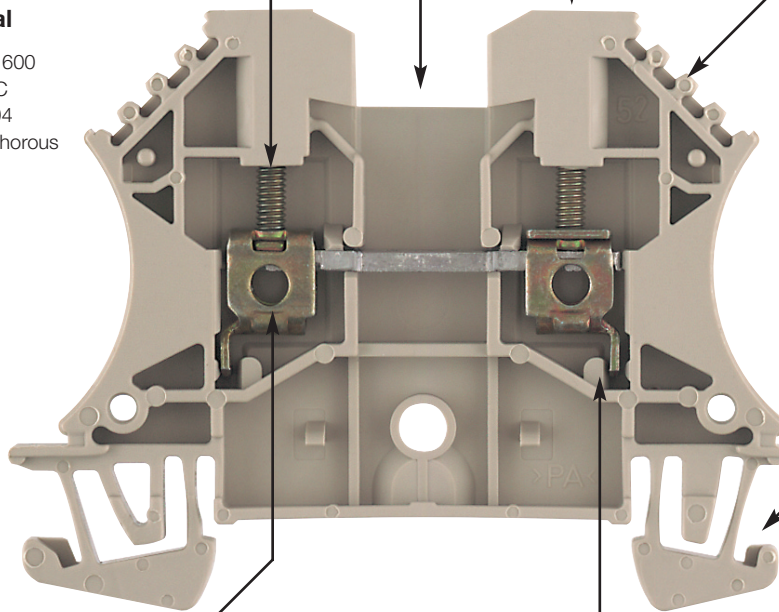

Safe contacts

- Elastic tension clamp compensates for changes in the conductors caused by fluctuations in temperature (prevents working loose)
- No maintenance: no need to retighten the clamping screw
- Vibration-proof connection: many W-terminals certified for railway use to EN 61373
- Highest contact force of all connection systems

Safe use

- Shock protection with connected conductors, even with cross-connection
- Terminals supplied with open clamping point. In addition, the misplugging safeguard prevents conductors from being inserted incorrectly (detailed photo).
- Embossing on tension clamp and busbar engage so that even the smallest conductors are reliably clamped; large conductors and also 2 conductors are gripped in the middle.

Same contours

- Identical size from 2.5 to 10 mm
- Small number of different accessory parts
- Easier project planning

Standards

The high contact safety and reliability of Weidmüller's systems is verified by:

- Type-testing to IEC 60947-7-1/-2
- National and international approvals
- Large portfolio with UL and CSA approvals
- W-series qualified to railway standards
- ATEX approval



Feed-through terminals

Standard design

Identical external profile for the 2.5mm² - 10mm² terminals enables the use of common endplates and partitions thus reducing stocking costs.

When using ATEX certified components in hazardous area applications the installation instructions and the rated data for accessories in the technical appendix must be considered.

Width/Length/Height with TS35x7.5	mm
Max. current / max. cond. cross-section	A/mm ²
Max. clamping range	mm ²

Technical data

Rated data	
Rated voltage	V
Rated current	A
Rated cross-section	mm ²
Rated impulse voltage / Pollution severity	kV/-
Plug gauge IEC 60-947-1 / flammability class acc. UL94	
Approvals	

Clampable conductors (H05V/H07V)	
Solid / stranded	mm ²
Flexible / flexible w. wire end ferrule	mm ²
Tightening torque range (clamping screw)	Nm
Stripping length / blade size	mm / -

2 clampable conductors of equal cross-section	
Solid / stranded	mm ²
Flexible / flexible w. wire end ferrule	mm ²

Information

Ordering data

Version	
	dark beige Wemid
	blue Wemid

Information

Accessories

Cross-connection, pluggable	
	2-pole
	3-pole
	4-pole
	10-pole
	41-/50-pole

Cross-connection, screwable	
	2-pole
	3-pole
	4-pole
	10-pole

End plate / partition	
<i>End plate</i>	dark beige Wemid
	blue Wemid
<i>Partition</i>	dark beige Wemid
	blue Wemid

End bracket	
	dark beige

Testing	
<i>For testing of wired terminal strips</i>	Standard version
	With spigot

Cover	
	With elec. shock warn. symbol
	neutral

Marking systems (see large assortment in chapter M)	
	Tags

For detailed information on additional accessories and usage instructions see chapter accessories.

WDU 1.5/ZZ

1.5 mm²

Additional connection right and left

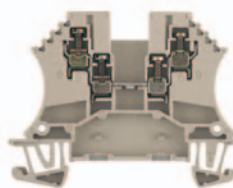

5.1 x 60 x 47
23 / 2.5
0.13 ... 2.5

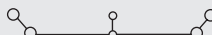

IEC 60947-7-1 EEx e II  T II 2 G D

IEC	UL	CSA	EN 50019
800	300	300	550
17.5	10	10	15
1.5	AWG 22 ...12	AWG 26...14	1.5
8 / 3			
A1 / V-0			

 KEMA 98ATEX1685 U

Rated connection	Additional connection
0.5...2.5 / 1.5...2.5	
0.5...1.5 / 0.5...1.5	
0.4...0.6 (M 2.5)	
7 / 3.5 x 0.6	

Mind the max. current of the terminal (23A) when using the cross-connection WQV!

Type	Qty.	Order No.
WDU 1.5/ZZ	100	1031400000
WDU 1.5/ZZ BL	100	1031480000

Type	Current [A]	Qty.	Order No.

Current [A]			
WQV 2.5/2	32	50	1053660000
WQV 2.5/3	32	50	1053760000
WQV 2.5/4	32	50	1053860000
WQV 2.5/10	32	20	1054460000

Width [mm]			
WAP 2.5-10	1.5	50	1050000000
WAP 2.5-10 BL	1.5	50	1050080000
WAP 16+35 WTW 2.5-10	1.5	20	1050100000
WAP 16+35 WTW 2.5-10 BL	1.5	20	1050180000

Width [mm]			
WEW-35/2	8	100	1061200000

Testing			
WTA 2 WDU2.5-10	25		1632320000
WTA 2/ZA WDU2.5-10	25		1632330000

Cover			
WAD 4 GE BED	50		1072000000
WAD 4 WS	50		1072100000

Marking systems			
WS 12/5 / DEK 5			

Test plug and socket see section Accessories W-series

WDU 2.5/1.5/ZR

2.5 mm²

Additional connection right

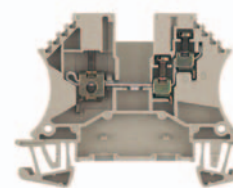

5.1 x 60 x 47
32 / 4
0.13 ... 4

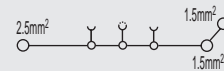

IEC 60947-7-1 EEx e II  T II 2 G D

IEC	UL	CSA	EN 50019
800	300	300	550
24	20	20	21
2.5	AWG 22 ...12	AWG 26...12	2.5
8 / 3			
A3 / A1 / V-0			

 KEMA 98ATEX1685 U

Rated connection	Additional connection
0.5...4 / 1.5...4	0.5...2.5 / 1.5...2.5
0.5...4 / 0.5...2.5	0.5...1.5 / 0.5...1.5
0.4...0.8 (M 2.5)	0.4...0.6 (M 2.5)
10 / 3.5 x 0.6	7 / 3.5 x 0.6

Additional connection	
0.5...1.5	0.5...1
0.5...1.5 / 0.5...1.5	0.5...1 / 0.5...0.75

Rated voltage 400V when using cross-connection ZQV

Type	Qty.	Order No.
WDU 2.5/1.5/ZR	100	1024700000
WDU 2.5/1.5/ZR BL	100	1024780000

Further connection (right 1.5 mm²): UL / CSA 15A and CSA AWG 14

Type	Current [A]	Qty.	Order No.
ZQV 2.5N/2 GE	24	60	1693800000
ZQV 2.5N/3 GE	24	60	1693810000
ZQV 2.5N/4 GE	24	60	1693820000
ZQV 2.5N/10 GE	24	20	1693880000
ZQV 2.5N/50 GE	24	10	1693890000

Current [A]			
WQV 2.5/2	32	50	1053660000
WQV 2.5/3	32	50	1053760000
WQV 2.5/4	32	50	1053860000
WQV 2.5/10	32	20	1054460000

Width [mm]			
WAP 2.5-10	1.5	50	1050000000
WAP 2.5-10 BL	1.5	50	1050080000
WAP 16+35 WTW 2.5-10	1.5	20	1050100000
WAP 16+35 WTW 2.5-10 BL	1.5	20	1050180000

Width [mm]			
WEW-35/2	8	100	1061200000

Testing			
WTA 2 WDU2.5-10	25		1632320000
WTA 2/ZA WDU2.5-10	25		1632330000

Cover			
WAD 5 MIT BLITZZEICHEN	50		1053460000
WAD 5 NEUTRAL	50		1056060000

Marking systems			
WS 12/5 / DEK 5			

Conductor 2.5 mm² with wire end ferrule with plastic collar only with diameter optimised collar (Order No. 1333100000, Qty. 500)

Feed-through terminals

WDU 2.5

2.5 mm²

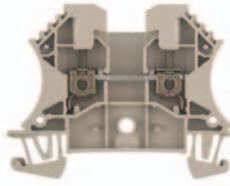

5.1 x 60 x 47
32 / 4
0.13 ... 4

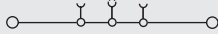

IEC 60947-7-1

EEx e II T II 2 G D

IEC	UL	CSA	EN 50019
800	600	600	550
24	25	20	21
2.5	AWG 22 ...12	AWG 26...12	2.5
8 / 3			
A3 / V-0			

KEMA 98ATEX1683 U

Rated connection	Additional connection
0.5...4 / 1.5...4	
0.5...4 / 0.5...2.5	
0.4...0.6 (M 2.5)	
10 / 3.5 x 0.6	

0.5...1.5
0.5...1.5 / 0.5...1.5

Conductor 2.5 mm² with wire end ferrule with plastic collar only with diameter optimised collar (Order No. 1333100000, Qty. 500)

Type	Qty.	Order No.
WDU 2.5	100	1020000000
WDU 2.5 BL	100	1020080000

Rated voltage 400V when using cross-connection ZQV
Colour-versions see section Accessories W-Series.

Type	Current [A]	Qty.	Order No.
ZQV 2.5N/2 GE	24	60	1693800000
ZQV 2.5N/3 GE	24	60	1693810000
ZQV 2.5N/4 GE	24	60	1693820000
ZQV 2.5N/10 GE	24	20	1693880000
ZQV 2.5N/50 GE	24	10	1693890000

Current [A]

WQV 2.5/2	32	50	1053660000
WQV 2.5/3	32	50	1053760000
WQV 2.5/4	32	50	1053860000
WQV 2.5/10	32	20	1054460000

Width [mm]

WAP 2.5-10	1.5	50	1050000000
WAP 2.5-10 BL	1.5	50	1050080000
WAP 16+35 WTW 2.5-10	1.5	20	1050100000
WAP 16+35 WTW 2.5-10 BL	1.5	20	1050180000

Width [mm]

WEW-35/2	8	100	1061200000
----------	---	-----	------------

WTA 2 WDU2.5-10	25	1632320000
WTA 2/ZA WDU2.5-10	25	1632330000

WAD 5 MIT BLITZZEICHEN	50	1053460000
WAD 5 NEUTRAL	50	1056060000

WS 12/5 / DEK 5

Test plug and socket see section Accessories W-series

WDK 2.5 ZQV

2.5 mm²

Pluggable cross-connection

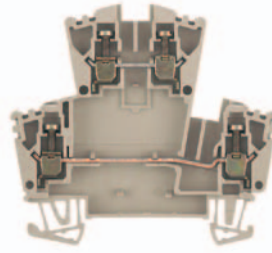

5.1 x 65.4 x 63
32 / 4
0.13 ... 4

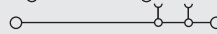

IEC 60947-7-1

IEC	UL	CSA	EN 50019
400	300	300	
24	20	25	
2.5	AWG 22 ...12	AWG 26...12	
6 / 3			
A3 / V-0			

KEMA 98ATEX1687 U

Rated connection	Additional connection
0.5...4 / 1.5...4	
0.5...4 / 0.5...2.5	
0.4...0.6 (M 2.5)	
10 / 3.5 x 0.6	

0.5...1.5
0.5...1.5 / 0.5...1.5

Conductor 2.5 mm² with wire end ferrule with plastic collar only with diameter optimised collar (Order No. 1333100000, Qty. 500)

Type	Qty.	Order No.
WDK 2.5 ZQV	100	1041100000
WDK 2.5 ZQV BL	100	1041180000

Rated voltage 400V when using cross-connection ZQV
Colour-versions see section Accessories W-Series.

Type	Current [A]	Qty.	Order No.
ZQV 2.5N/2 GE	24	60	1693800000
ZQV 2.5N/3 GE	24	60	1693810000
ZQV 2.5N/4 GE	24	60	1693820000
ZQV 2.5N/10 GE	24	20	1693880000
ZQV 2.5N/50 GE	24	10	1693890000

Current [A]

WQV 2.5/2	32	50	1053660000
WQV 2.5/3	32	50	1053760000
WQV 2.5/4	32	50	1053860000
WQV 2.5/10	32	20	1054460000

Width [mm]

WAP WDK2.5	1.5	20	1059100000
WAP WDK2.5 BL	1.5	20	1059180000
WTW EN	1.5	20	1058800000

Width [mm]

WEW-35/2	8	100	1061200000
----------	---	-----	------------

WAD 4 GE BED	50	1072000000
WAD 4 WS	50	1072100000

WS 8/5 / DEK 5

Test plug and socket see section Accessories W-series

WDK 2.5

2.5 mm²

Screwable cross-connection

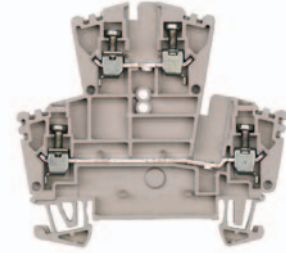

5.1 x 69 x 63
32 / 4
0.13 ... 4

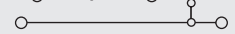

IEC 60947-7-1

IEC	UL	CSA	EN 50019
400	300	300	275
24	20	10	21
2.5	AWG 22 ...12	AWG 26...12	2.5
6 / 3			
A3 / V-0			

KEMA 98ATEX1687 U

Rated connection	Additional connection
0.5...4 / 1.5...4	
0.5...4 / 0.5...2.5	
0.4...0.6 (M 2.5)	
10 / 3.5 x 0.6	

0.5...1.5
0.5...1.5 / 0.5...1.5

Conductor 2.5 mm² with wire end ferrule with plastic collar only with diameter optimised collar (Order No. 1333100000, Qty. 500)

Type	Qty.	Order No.
WDK 2.5	100	1021500000
WDK 2.5 BL	100	1021580000

Colour versions see section Accessories W-series Specific functions

Type	Current [A]	Qty.	Order No.
ZQV 2.5N/2 GE	24	60	1693800000
ZQV 2.5N/3 GE	24	60	1693810000
ZQV 2.5N/4 GE	24	60	1693820000
ZQV 2.5N/10 GE	24	20	1693880000
ZQV 2.5N/50 GE	24	10	1693890000

Current [A]

WQV 2.5/2	32	50	1053660000
WQV 2.5/3	32	50	1053760000
WQV 2.5/4	32	50	1053860000
WQV 2.5/10	32	20	1054460000

Width [mm]

WAP WDK2.5	1.5	20	1059100000
WAP WDK2.5 BL	1.5	20	1059180000
WTW EN	1.5	20	1058800000

Width [mm]

WEW-35/2	8	100	1061200000
----------	---	-----	------------

WAD 4 GE BED	50	1072000000
WAD 4 WS	50	1072100000

WS 8/5 / DEK 5

Test plug and socket see section Accessories W-series

Feed-through terminals

Standard design

Identical external profile for the 2.5mm² - 10mm² terminals enables the use of common endplates and partitions thus reducing stocking costs.

When using ATEX certified components in hazardous area applications the installation instructions and the rated data for accessories in the technical appendix must be considered.

Width/Length/Height with TS35x7.5	mm
Max. current / max. cond. cross-section	A/mm ²
Max. clamping range	mm ²

Technical data

Rated data	
Rated voltage	V
Rated current	A
Rated cross-section	mm ²
Rated impulse voltage / Pollution severity	kV/-
Plug gauge IEC 60-947-1 / flammability class acc. UL94	
Approvals	

Clampable conductors (H05V/H07V)	
Solid / stranded	mm ²
Flexible / flexible w. wire end ferrule	mm ²
Tightening torque range (clamping screw)	Nm
Stripping length / blade size	mm / -

2 clampable conductors of equal cross-section	
Solid / stranded	mm ²
Flexible / flexible w. wire end ferrule	mm ²

Information
Conductor 2.5 mm ² with wire end ferrule with plastic collar only with diameter optimised collar (Order No. 1333100000, Qty. 500)

Ordering data

Version	Type	Qty.	Order No.
dark beige Wemid	WDK 2.5V	100	1022300000
blue Wemid	WDK 2.5V BL	100	1022380000

Information
Colour versions see section Accessories W-series Specific functions

Accessories

Cross-connection, pluggable	
	(ZQV 2.5N/4)
	2-pole
	3-pole
	4-pole
	10-pole
	41-/50-pole

Cross-connection, screwable	
	(WQV 2.5-3)
	2-pole
	3-pole
	4-pole
	10-pole

End plate / partition	
End plate	dark beige Wemid
	blue Wemid
Partition	dark beige Wemid
	blue Wemid

End bracket	
	dark beige

Testing	
For testing of wired terminal strips	Standard version
	With spigot

Cover	
	With elec. shock warn. symbol
	neutral

Marking systems (see large assortment in chapter M)	
	Tags

For detailed information on additional accessories and usage instructions see chapter accessories.

WDK 2.5 V

2.5 mm²

Both levels on one potential



5.1 x 69 x 63	
32 / 4	
0.13 ... 4	

IEC 60947-7-1 EEx e II  T II 2 G D

IEC	UL	CSA	EN 50019
400	300	300	275
24	20	10	21
2.5	AWG 22 ...12	AWG 26...12	2.5
6 / 3			
A3 / V-0			

 KEMA 98ATEX1687 U

Rated connection	Additional connection
0.5...4 / 1.5...4	
0.5...4 / 0.5...2.5	
0.4...0.6 (M 2.5)	
10 / 3.5 x 0.6	

0.5...1.5	
0.5...1.5 / 0.5...1.5	

Conductor 2.5 mm² with wire end ferrule with plastic collar only with diameter optimised collar (Order No. 1333100000, Qty. 500)

WDK 2.5 DU-PE

2.5 mm²

Lower level earthed on mounting rail

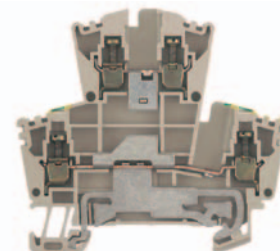

5.1 x 69 x 63	
32 / 4	
0.13 ... 4	

IEC 60947-7-1 (-7-2) EEx e II  T II 2 G D

IEC	UL	CSA	EN 50019
400	300	300	275
24	20	10	21
2.5	AWG 22 ...12	AWG 26...12	2.5
6 / 3			
A3 / V-0			

 KEMA 98ATEX1687 U

Rated connection	Additional connection
0.5...4 / 1.5...4	
0.5...4 / 0.5...2.5	
0.4...0.6 (M 2.5)	
10 / 3.5 x 0.6	

0.5...1.5	
0.5...1.5 / 0.5...1.5	

Conductor 2.5 mm² with wire end ferrule with plastic collar only with diameter optimised collar (Order No. 1333100000, Qty. 500)

Type	Qty.	Order No.
WDK 2.5DU-PE	100	1036400000

Colour versions see section Accessories W-series Specific functions

Type	Current [A]	Qty.	Order No.

Current [A]	
WQV 2.5/2	32 50 1053660000
WQV 2.5/3	32 50 1053760000
WQV 2.5/4	32 50 1053860000
WQV 2.5/10	32 20 1054460000

Width [mm]	
WAP WDK2.5	1.5 20 1059100000
WAP WDK2.5 BL	1.5 20 1059180000
WTW EN	1.5 20 1058800000

Width [mm]	
WEW-35/2	8 100 1061200000

WAD 4 GE BED	50 1072000000
WAD 4 WS	50 1072100000

WS 8/5 / DEK 5	
----------------	--

Test plug and socket see section Accessories W-series

Type	Current [A]	Qty.	Order No.

Current [A]	
WQV 2.5/2	32 50 1053660000
WQV 2.5/3	32 50 1053760000
WQV 2.5/4	32 50 1053860000
WQV 2.5/10	32 20 1054460000

Width [mm]	
WAP WDK2.5	1.5 20 1059100000
WAP WDK2.5 BL	1.5 20 1059180000
WTW EN	1.5 20 1058800000

Width [mm]	
WEW-35/2	8 100 1061200000

WAD 4 GE BED	50 1072000000
WAD 4 WS	50 1072100000

WS 8/5 / DEK 5	
----------------	--

Test plug and socket see section Accessories W-series

Feed-through terminals

WDK 2.5 EX

2.5 mm²

Rated voltage 800V

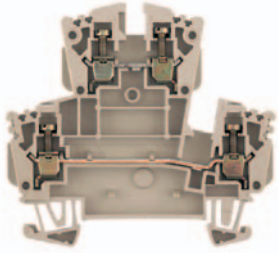

6.1 x 69 x 63
32 / 4
0.13 ... 4

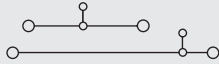

IEC 60947-7-1

IEC	UL	CSA	EN 50019
800			
24			
2.5			
8 / 3			
A3 / V-0			



Rated connection	Additional connection
0.5...4 / 1.5...4	
0.5...4 / 0.5...2.5	
0.4...0.6 (M 2.5)	
10 / 3.5 x 0.6	

0.5...1.5
0.5...1.5 / 0.5...1.5

Type	Qty.	Order No.
WDK 2.5/EX	100	1029100000

Type	Current [A]	Qty.	Order No.

Current [A]			
Q 2 AKZ4SS	24	50	0369000000
Q 3 AKZ4SS	24	50	0369100000
Q 4 AKZ4SS	24	50	0369200000
Q 10 AKZ4SS	24	20	0369300000

Width [mm]			
WAP WDK2.5	1.5	20	1059100000
WAP WDK2.5 BL	1.5	20	1059180000
WAP 16+35 WTW 2.5-10	1.5	20	1050100000

Width [mm]			
WEW-35/2	8	100	1061200000

WAD 4 GE BED	50	1072000000
WAD 4 WS	50	1072100000

WS 8/5 / DEK 6

WDU 4

4 mm²

Rated voltage 800V

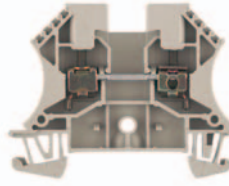

6.1 x 60 x 47
41 / 6
0.13 ... 6

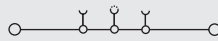

IEC 60947-7-1

IEC	UL	CSA	EN 50019
800	600	600	750
32	35	35	28
4	AWG 22 ...10	AWG 26...10	4
8 / 3			
A4 / V-0			



EEx e II T II 2 G D

KEMA 98ATEX1683 U

Rated connection	Additional connection
0.5...6 / 1.5...6	
0.5...6 / 0.5...4	
0.5...1.0 (M 3)	
10 / 3.5 x 0.6	

0.5...2.5
0.5...1.5 / 0.5...1.5

Mind the max. current of the terminal (41A) when using the cross-connection WQV!

Type	Qty.	Order No.
WDU 4	100	1020100000
WDU 4 BL	100	1020180000

Rated voltage 400V when using cross-connection ZQV
Colour-versions see section Accessories W-Series.

Type	Current [A]	Qty.	Order No.
ZQV 4N/2	32	60	1758250000
ZQV 4N/3	32	60	1762630000
ZQV 4N/4	32	60	1762620000
ZQV 4N/10	32	20	1758260000
ZQV 4N/41	32	10	1758270000

Current [A]			
WQV 4/2	41	50	1051960000
WQV 4/3	41	50	1054560000
WQV 4/4	41	50	1054660000
WQV 4/10	41	20	1052060000

Width [mm]			
WAP 2.5-10	1.5	50	1050000000
WAP 2.5-10 BL	1.5	50	1050080000
WAP 16+35 WTW 2.5-10	1.5	20	1050100000
WAP 16+35 WTW 2.5-10 BL	1.5	20	1050180000

Width [mm]			
WEW-35/2	8	100	1061200000

WTA 3 WDU4	25	1632350000
WTA 3/ZA WDU4	25	1632360000

WAD 5 MIT BLITZZEICHEN	50	1053460000
WAD 5 NEUTRAL	50	1056060000

DEK 6 / WS 12/6

Test plug and socket see section Accessories W-series

WDU 6

6 mm²

Rated voltage 800V

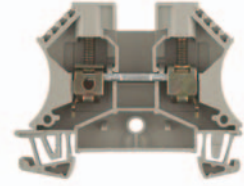

7.9 x 60 x 47
57 / 10
0.33 ... 10

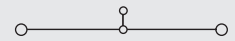

IEC 60947-7-1

IEC	UL	CSA	EN 50019
800	600	600	550
41	50	45	36
6	AWG 22 ...8	AWG 20...8	6
8 / 3			
A5 / V-0			



EEx e II T II 2 G D

KEMA 98ATEX1683 U

Rated connection	Additional connection
0.5...10 / 1.5...10	
0.5...10 / 0.5...6	
0.8...1.6 (M 3.5)	
12 / 4.0 x 0.8	

0.5...2.5
0.5...2.5 / 0.5...2.5

Mind the max. current of the terminal (57A) when using the cross-connection WQV!

Type	Qty.	Order No.
WDU 6	100	1020200000
WDU 6 BL	100	1020280000

Colour versions see section Accessories W-series Specific functions

Type	Current [A]	Qty.	Order No.

Current [A]			
WQV 6/2	57	50	1052360000
WQV 6/3	57	50	1054760000
WQV 6/4	57	50	1054860000
WQV 6/10	57	20	1052260000

Width [mm]			
WAP 2.5-10	1.5	50	1050000000
WAP 2.5-10 BL	1.5	50	1050080000
WAP 16+35 WTW 2.5-10	1.5	20	1050100000
WAP 16+35 WTW 2.5-10 BL	1.5	20	1050180000

Width [mm]			
WEW-35/2	8	100	1061200000

WTA 5/1	25	1051260000
---------	----	------------

WAD 8 MIT BLITZZEICHEN	50	1053560000
WAD 8 NEUTRAL	50	1056160000

DEK 8 / WS 12/6,5

Test plug and socket see section Accessories W-series

Feed-through terminals

Standard design

Identical external profile for the 2.5mm² - 10mm² terminals enables the use of common endplates and partitions thus reducing stocking costs.

When using ATEX certified components in hazardous area applications the installation instructions and the rated data for accessories in the technical appendix must be considered.

Width/Length/Height with TS35x7.5	mm
Max. current / max. cond. cross-section	A/mm ²
Max. clamping range	mm ²

Technical data

Rated data	
Rated voltage	V
Rated current	A
Rated cross-section	mm ²
Rated impulse voltage / Pollution severity	kV/-
Plug gauge IEC 60-947-1 / flammability class acc. UL94	
Approvals	

Clampable conductors (H05V/H07V)	
Solid / stranded	mm ²
Flexible / flexible w. wire end ferrule	mm ²
Tightening torque range (clamping screw)	Nm
Stripping length / blade size	mm / -

2 clampable conductors of equal cross-section	
Solid / stranded	mm ²
Flexible / flexible w. wire end ferrule	mm ²

Information

Ordering data

Version	
dark beige Wemid	
blue Wemid	

Information

Accessories

Cross-connection, pluggable	
	(ZQV 2.5N/4)
	2-pole
	3-pole
	4-pole
	10-pole
	41-/50-pole

Cross-connection, screwable	
	(WQV 2.5-3)
	2-pole
	3-pole
	4-pole
	10-pole

End plate / partition	
End plate	dark beige Wemid blue Wemid
Partition	dark beige Wemid blue Wemid

End bracket	
	dark beige

Testing	
For testing of wired terminal strips	Standard version With spigot

Cover	
	With elec. shock warn. symbol neutral

Marking systems (see large assortment in chapter M)	
	Tags

For detailed information on additional accessories and usage instructions see chapter accessories.

WDU 10



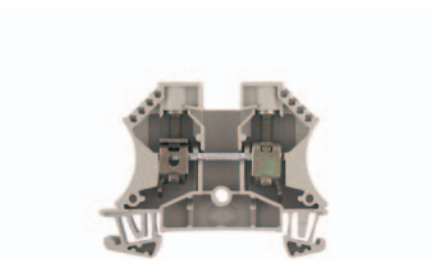

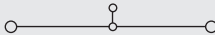

10 mm²



9.9 x 60 x 47	
76 / 16	
0.82 ... 16	

IEC 60947-7-1 EEx e II  T II 2 G D

IEC	UL	CSA	EN 50019
1000	600	600	550
57	65	65	50
10	AWG 18 ...6	AWG 16...6	10
8 / 3			
B6 / V-0			

       KEMA 98ATEX1683 U

Rated connection	Additional connection
1.5...16 / 1.5...16	
1.5...16 / 1.5...16	
1.2...2.4 (M 4)	
12 / 5.5 x 1.0	

1...6	
1...6 / 1...6	

Mind the max. current of the terminal (76A) when using the cross-connection WQV!

Type	Qty.	Order No.
WDU 10	50	1020300000
WDU 10 BL	50	1020380000

Colour versions see section Accessories W-series

Type	Current [A]	Qty.	Order No.

Current [A]			
WQV 10/2	76	50	1052560000
WQV 10/3	63	50	1054960000
WQV 10/4	63	50	1055060000
WQV 10/10	63	20	1052460000

Width [mm]			
WAP 2.5-10	1.5	50	1050000000
WAP 2.5-10 BL	1.5	50	1050080000
WAP 16+35 WTW 2.5-10	1.5	20	1050100000
WAP 16+35 WTW 2.5-10 BL	1.5	20	1050180000

Width [mm]			
WEW-35/2	8	100	1061200000
WTA 5/1		25	1051260000

WAD 8 MIT BLITZZEICHEN	50	1053560000
WAD 8 NEUTRAL	50	1056160000

WS 12/6,5 / DEK 5	
-------------------	--

Test plug and socket see section Accessories W-series

WDU 10/ZR

10 mm²



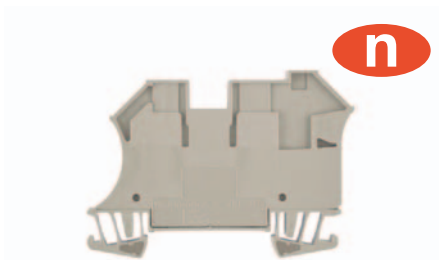



Supplementary connection, right (4mm²)



9.9 x 70 x 49.5	
76 / 16	
1.31 ... 16	

IEC 60947-7-1

IEC	UL	CSA	EN 50019
800	600	600	
57	65	65	
10	AWG 16 ...6	AWG 16...6	
8 / 3			
B6 / A4 / V-0			

Rated connection	Additional connection
1.5...16 / 1.5...16	0.5...6 / 1.5...4
1.5...16 / 1.5...16	0.5...4 / 0.5...4
1.2...2.4 (M 4)	0.6...0.8 (M 3)
12 / 5.5 x 1.0	9 / 3.5 x 0.6

1...6	0.5...1.5
1...6 / 1...6	0.5...1.5 / 0.5...1.5

Mind the max. current of the terminal (76A) when using the cross-connection WQV! Supplementary connection on top right (4mm²)

Type	Qty.	Order No.
WDU 10/ZR	50	1042400000
WDU 10/ZR BL	50	1042480000

Rated data refer to the 10mm² connection. ATEX-approval in preparation.

Type	Current [A]	Qty.	Order No.

Current [A]			
WQV 10/2	76	50	1052560000
WQV 10/3	63	50	1054960000
WQV 10/4	63	50	1055060000
WQV 10/10	63	20	1052460000

Width [mm]			
WAP 16+35 WTW 2.5-10	1.5	20	1050100000
WAP 16+35 WTW 2.5-10 BL	1.5	20	1050180000

Width [mm]			
WEW-35/2	8	100	1061200000
WTA 5/1		25	1051260000

WS 12/6,5 / DEK 5	
-------------------	--

WS 12/6,5 / DEK 5	
-------------------	--

Test plug and socket see section Accessories W-series

Feed-through terminals

WDU 16

16 mm²

With spigot for higher interconnection-stability

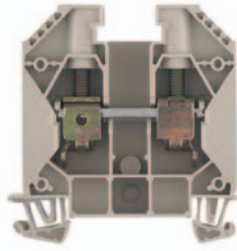

11.9 x 60 x 63
101 / 25
0.82 ... 25

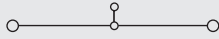

IEC 60947-7-1 EEx e II T II 2 G D

IEC	UL	CSA	EN 50019
1000	600	600	750
76	85	65	66
16	AWG 18 ...6	AWG 14...6	16
8 / 3			
B7 / V-0			

KEMA 98ATEX1683 U

Rated connection **Additional connection**

1.5...16 / 1.5...25
1.5...25 / 1.5...16
2.0...4.0 (M 5)
16 / 5.5 x 1.0

1.5...6
1.5...6 / 1.5...6

Type	Qty.	Order No.
WDU 16/ZA	50	1028900000
WDU 16/ZA BL	50	1028980000

Order No. 1020400000 and 1020480000 (blue) versions without spigot (Qty. 50)

WDU 35

35 mm²

Clamping screw / spigot (intercon.-stability)

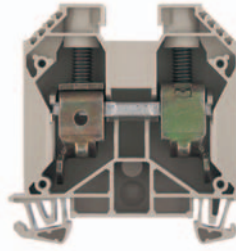

16 x 60 x 63
150 / 50
2.5 ... 50

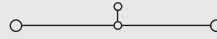

IEC 60947-7-1 EEx e II T II 2 G D

IEC	UL	CSA	EN 50019
1000	600	600	750
125	115	120	109
35	AWG 12 ...2	AWG 12...2	35
8 / 3			
B8 / V-0			

KEMA 98ATEX1683 U

Rated connection **Additional connection**

2.5...16 / 2.5...50
2.5...35 / 2.5...35
2.5...5.0 (M 6)
18 / 6.5 x 1.2

2.5...10 / 16...16
2.5...16 / 2.5...16

50mm² stranded conductor has to be connected with 4Nm

Type	Qty.	Order No.
WDU 35/ZA	40	1028800000
WDU 35/ZA BL	40	1028880000

Order No. 1020500000 and 1020580000 (blue) versions without spigot (Qty. 40)

WDU 35 IK

35 mm²

Hex. socket screw / spigot (intercon.-stab.)

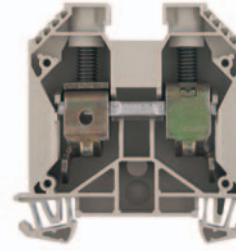

16 x 60 x 63
150 / 50
2.5 ... 50

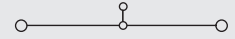

IEC 60947-7-1

IEC	UL	CSA	EN 50019
1000	600	600	
125	115	120	
35	AWG 12 ...2	AWG 12...2	
8 / 3			
B8 / V-0			

Rated connection **Additional connection**

2.5...16 / 2.5...50
2.5...35 / 2.5...35
3.0...6.0 (hexagon) (M 6)
18 / S6 (DIN 6911)

2.5...10 / 16...16
2.5...16 / 2.5...16

Type	Qty.	Order No.
WDU 35/IK/ZA	25	1029000000
WDU 35/IK/ZA BL	25	1029080000

Order No. 1020600000 and 1020680000 (blue) versions without spigot (Qty. 25)

Type	Current [A]	Qty.	Order No.

Current [A]			
WQV 16/2	101	50	1053260000
WQV 16/3	76	50	1055160000
WQV 16/4	76	50	1055260000
WQV 16/10	76	10	1053360000

Width [mm]			

WAP 16+35 WTW 2.5-10	1.5	20	1050100000
WAP 16+35 WTW 2.5-10 BL	1.5	20	1050180000

Width [mm]			
WEW 35/1	12.2	50	1059000000

WAD 12 M. BLITZZEICHEN	50	1055960000
WAD 12 NEUTRAL	50	1056260000

WS 12/6,5 / DEK 5

Test plug and socket see section Accessories W-series

Type	Current [A]	Qty.	Order No.

Current [A]			
WQV 35/2	138	50	1053060000
WQV 35/3	112	50	1055360000
WQV 35/4	112	50	1055460000
WQV 35/10	112	10	1053160000

Width [mm]			

WAP 16+35 WTW 2.5-10	1.5	20	1050100000
WAP 16+35 WTW 2.5-10 BL	1.5	20	1050180000

Width [mm]			
WEW 35/1	12.2	50	1059000000

WAD 12 M. BLITZZEICHEN	50	1055960000
WAD 12 NEUTRAL	50	1056260000

WS 12/6,5 / DEK 5

Test plug and socket see section Accessories W-series

Type	Current [A]	Qty.	Order No.

Current [A]			
WQV 35/2	138	50	1053060000
WQV 35/3	112	50	1055360000
WQV 35/4	112	50	1055460000
WQV 35/10	112	10	1053160000

Width [mm]			

WAP 16+35 WTW 2.5-10	1.5	20	1050100000
WAP 16+35 WTW 2.5-10 BL	1.5	20	1050180000

Width [mm]			
WEW 35/1	12.2	50	1059000000

WAD 12 M. BLITZZEICHEN	50	1055960000
WAD 12 NEUTRAL	50	1056260000

WS 12/6,5 / DEK 5

Test plug and socket see section Accessories W-series

Feed-through terminals

Standard design

Identical external profile for the 2.5mm² - 10mm² terminals enables the use of common endplates and partitions thus reducing stocking costs.

When using ATEX certified components in hazardous area applications the installation instructions and the rated data for accessories in the technical appendix must be considered.

Width/Length/Height with TS35x7.5	mm
Max. current / max. cond. cross-section	A/mm ²
Max. clamping range	mm ²

Technical data

Rated data	
Rated voltage	V
Rated current	A
Rated cross-section	mm ²
Rated impulse voltage / Pollution severity	kV/-
Plug gauge IEC 60-947-1 / flammability class acc. UL94	
Approvals	

Clampable conductors (H05V/H07V)	
Solid / stranded	mm ²
Flexible / flexible w. wire end ferrule	mm ²
Tightening torque range (clamping screw)	Nm
Stripping length / blade size	mm / -

2 clampable conductors of equal cross-section	
Solid / stranded	mm ²
Flexible / flexible w. wire end ferrule	mm ²

Information
95 and 120mm ² have to be connected with at least 10Nm.

Ordering data

Version	
dark beige Wemid	
blue Wemid	

Information
For details on the connection of the conductor and on direct mounting see section Accessories W-Series

Accessories

Cross-connection, pluggable	
	2-pole 3-pole 4-pole 10-pole 41-/50-pole

Cross-connection, screwable	
	2-pole 3-pole 4-pole 10-pole

End plate / partition	
End plate	dark beige Wemid blue Wemid
Partition	dark beige Wemid blue Wemid

End bracket	
	dark beige

Testing	
For testing of wired terminal strips	Standard version With spigot

Cover	
	With elec. shock warn. symbol neutral

Marking systems (see large assortment in chapter M)	
	Tags

For detailed information on additional accessories and usage instructions see chapter accessories.

WDU 70/95

95 mm²

Conductor insertable from above

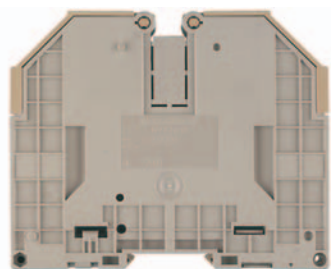

27 x 132 x 108	
232 / 120	
13.3 ... 120	

IEC 60947-7-1 EEx e II  T II 2 G D

IEC	UL	CSA	EN 50019
1000	600	600	750
232	175	205	202
95	AWG 6 ...2/0	AWG 6...2/0	95
8 / 3			
B12 / V-0			

 KEMA 98ATEX1686 U

Rated connection	Additional connection
16...16 / 16...120	
16...95 / 16...95	
6.0...12 (hexagon) (M 8)	
30 / S6 (DIN 6911)	

16...16 / 16...35
16...35 / 16...35

Information
95 and 120mm ² have to be connected with at least 10Nm.

Type	Qty.	Order No.
WDU 70/95	10	1024600000
WDU 70/95 BL	10	1024680000



For details on the connection of the conductor and on direct mounting see section Accessories W-Series

WDU 120/150

150 mm²

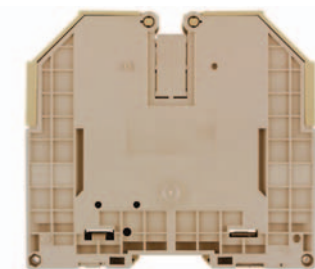
Conductor insertable from above



32 x 132 x 118	
309 / 150	
33.62 ... 150	

IEC 60947-7-1 EEx e II  T II 2 G D

IEC	UL	CSA	EN 50019
1000	600	600	1100
309	225	285	234
150	AWG 2 ...250 kcmil	AWG 2...250 kcmil	150
8 / 3			
B13 / V-0			

 KEMA 98ATEX1686 U

Rated connection	Additional connection
/ 35...150	
35...150 / 35...95	
10...20 (hexagon) (M 10)	
35 / S6 (DIN 6911)	

/ 35...70
35...70 / 35...70

Information
95 and 120mm ² have to be connected with at least 10Nm.

Type	Qty.	Order No.
WDU 120/150	10	1024500000
WDU 120/150/ BL	10	1024580000

For details on the connection of the conductor and on direct mounting see section Accessories W-Series

Type	Current [A]	Qty.	Order No.

Current [A]			
WQV 70/95/2	232	5	1063500000
WQV 70/95/3	232	5	1063600000

Width [mm]			

Width [mm]			
WEW 35/1	12.2	50	1059000000

WAD 27 M. BLITZZEICHEN	10	1062860000
WAD 27 NEUTRAL	10	1062960000

Width [mm]			
WS 12/6,5 / DEK 5			

Auxiliary connection for additional conductor WZAD 70 Order no. **1066000000** (up to 4mm², 32A). Test plug see accessories.

Type	Current [A]	Qty.	Order No.

Current [A]			
WQV 120/2	292	5	1063300000
WQV 120/3	292	5	1063400000

Width [mm]			

Width [mm]			
WEW 35/1	12.2	50	1059000000

WAD 27 M. BLITZZEICHEN	10	1062860000
WAD 27 NEUTRAL	10	1062960000

Width [mm]			
WS 12/6,5 / DEK 5			

Auxiliary connection for additional conductor WZAD 120 Order no. **1066100000** (up to 4mm², 32A). Test plug see accessories.

Feed-through terminals

WDU 240

240 mm²



36 x 100 x 131.5
415 / 240
70 ... 240

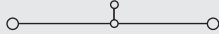

IEC 60947-7-1

EEx e II T II 2 G D

IEC	UL	CSA	EN 50019
1000	600	600	750
415	380	400	300
240	...500 MCM	1/0...500 MCM	240
8 / 3			
B15 / V-0			



KEMA 01ATEX2186 U

Rated connection	Additional connection
/ 70...240	
70...240 / 70...185	
10...20 (hexagon) (M 10)	
40 / S8 (DIN 6911)	

/ 35...95	
50...95 / 35...50	

Type	Qty.	Order No.
WDU 240	2	1802780000
WDU 240 BL	2	1822210000

Type	Current [A]	Qty.	Order No.
Current [A]			
WQB 240/2	320	5	1802790000
WQB 240/3	320	5	1802800000
Width [mm]			
Width [mm]			
WEW 35/1	12.2	50	1059000000

DEK 5/5 / WS 12/6,5

Auxiliary connection for additional conductor WZAD 240 Order 1802810000 (up to 10mm², 57A). Test plug see accessories.

Articles with coloured order number are kept permanently in stock at the central warehouse in Germany. Delivery times see page X.2

Feed-through terminals

Compact design

The compact design of these protective conductor terminals makes them the obvious choice in confined spaces.

When using ATEX certified components in hazardous area applications the installation instructions and the rated data for accessories in the technical appendix must be considered.

Width/Length/Height with TS35x7.5	mm
Max. current / max. cond. cross-section	A/mm ²
Max. clamping range	mm ²

Technical data

Rated data	
Rated voltage	V
Rated current	A
Rated cross-section	mm ²
Rated impulse voltage / Pollution severity	kV/-
Plug gauge IEC 60-947-1 / flammability class acc. UL94	
Approvals	

Clampable conductors (H05V/H07V)	
Solid / stranded	mm ²
Flexible / flexible w. wire end ferrule	mm ²
Tightening torque range (clamping screw)	Nm
Stripping length / blade size	mm / -

2 clampable conductors of equal cross-section	
Solid / stranded	mm ²
Flexible / flexible w. wire end ferrule	mm ²

Information	
Conductor 2.5 mm ² with wire end ferrule with plastic collar only with diameter optimised collar (Order No. 1333100000, Qty. 500)	

Ordering data

Version	
dark beige Wemid	
blue Wemid	

Information	
Colour versions see section Accessories W-series Specific functions	

Accessories

Cross-connection, pluggable	
	2-pole
	3-pole
	4-pole
	10-pole
	41-/50-pole

Cross-connection, screwable	
	2-pole
	3-pole
	4-pole
	10-pole

End plate / partition	
End plate	dark beige Wemid blue Wemid
Partition	dark beige Wemid blue Wemid

End bracket	
	dark beige

Testing	
For testing of wired terminal strips	Standard version With spigot

Cover	
	With elec. shock warn. symbol neutral

Marking systems (see large assortment in chapter M)	
	Tags

For detailed information on additional accessories and usage instructions see chapter accessories.

WDU 2.5N

2.5 mm²

With screwable cross-connection

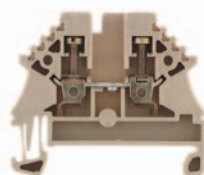

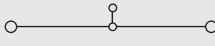
5.1 x 44 x 37.5	
32 / 4	
0.13 ... 4	

IEC 60947-7-1 EEx e II  T II 2 G D

IEC	UL	CSA	EN 50019
500	300	300	420
24	10	10	21
2.5	AWG 22 ...12	AWG 26...12	2.5
6 / 3			
A3 / V-0			

 KEMA 98ATEX1683 U

Rated connection	Additional connection
0.5...4 / 1.5...4	
0.5...4 / 0.5...2.5	
0.4...0.6 (M 2.5)	
10 / 3.5 x 0.6	

0.5...1.5	
0.5...1.5 / 0.5...1.5	

Conductor 2.5 mm² with wire end ferrule with plastic collar only with diameter optimised collar (Order No. 1333100000, Qty. 500)

Type	Qty.	Order No.
WDU 2.5N	100	1023700000
WDU 2.5N BL	100	1023780000

Colour versions see section Accessories W-series Specific functions

Type	Current [A]	Qty.	Order No.

Current [A]			
WQV 2.5/2	32	50	1053660000
WQV 2.5/3	32	50	1053760000
WQV 2.5/4	32	50	1053860000
WQV 2.5/10	32	20	1054460000

Width [mm]			
WAP WDU2.5N/4N	1.5	50	1060000000
WAP WDU2.5N/4N BL	1.5	50	1060080000

Width [mm]			
EW 35	8.5	50	0383560000

WTA 1 WDU1.5	25	1632290000
WTA 1/ZA WDU1.5	25	1632300000

WAD 4 GE BED	50	1072000000
WAD 4 WS	50	1072100000

WS 12/5 / DEK 5
Socket, test plug and screen plug see chapter accessories

WDU 2.5N/ZQV

2.5 mm²

With pluggable cross-connection

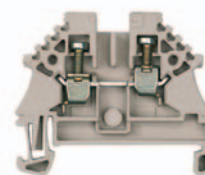

5.1 x 44 x 37.5	
32 / 4	
0.13 ... 4	

IEC 60947-7-1

IEC	UL	CSA	EN 50019
500	300	300	
24	20	20	
2.5	AWG 22 ...12	AWG 26...12	
6 / 3			
A3 / V-0			



Rated connection	Additional connection
0.5...4 / 1.5...4	
0.5...4 / 0.5...2.5	
0.4...0.6 (M 2.5)	
10 / 3.5 x 0.6	

0.5...1.5	
0.5...1.5 / 0.5...1.5	

Conductor 2.5 mm² with wire end ferrule with plastic collar only with diameter optimised collar (Order No. 1333100000, Qty. 500)

Type	Qty.	Order No.
WDU 2.5N ZQV	100	1040800000
WDU 2.5N ZQV BL	100	1040880000

When using the cross-connection ZQV, the rated voltage is reduced to 400V.

Type	Current [A]	Qty.	Order No.
ZQV 2.5N/2 GE	24	60	1693800000
ZQV 2.5N/3 GE	24	60	1693810000
ZQV 2.5N/4 GE	24	60	1693820000
ZQV 2.5N/10 GE	24	20	1693880000
ZQV 2.5N/50 GE	24	10	1693890000

Current [A]			

Width [mm]			
WAP WDU2.5N/4N	1.5	50	1060000000
WAP WDU2.5N/4N BL	1.5	50	1060080000

Width [mm]			
EW 35	8.5	50	0383560000

WTA 1 WDU1.5	25	1632290000
WTA 1/ZA WDU1.5	25	1632300000

WAD 4 GE BED	50	1072000000
WAD 4 WS	50	1072100000

WS 12/5 / DEK 5

Feed-through terminals

WDU 2.5N/600 UL

2.5 mm²

600V UL/CSA

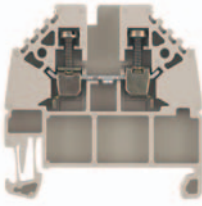

5.1 x 44 x 43.5
32 / 4
0.13 ... 4

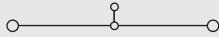

IEC 60947-7-1

IEC	UL	CSA	EN 50019
800	600	600	
24	25	20	
2.5	AWG 22 ...12	AWG 26...12	
8 / 3			
A3 / V-0			



Rated connection	Additional connection
0.5...4 / 1.5...4	
0.5...4 / 0.5...2.5	
0.4...0.6 (M 2.5)	
10 / 3.5 x 0.6	

0.5...1.5
0.5...1.5 / 0.5...1.5

Conductor 2.5 mm² with wire end ferrule with plastic collar only with diameter optimised collar (Order No. 1333100000, Qty. 500)

Type	Qty.	Order No.
WDU 2.5N/600UL	100	1730940000

WDK 2.5N

2.5 mm²

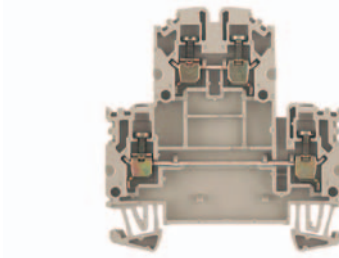

5.1 x 60.7 x 62.5
28 / 4
0.13 ... 4

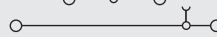

IEC 60947-7-1

EEx e II T II 2 G D

IEC	UL	CSA	EN 50019
800	600	300	550
24	20	20	21
2.5	AWG 26 ...12	AWG 26...12	2.5
8 / 3			
A3 / V-0			



KEMA 00ATEX2061 U

Rated connection	Additional connection
0.5...4 / 1.5...4	
0.5...4 / 0.5...2.5	
0.4...0.6 (M 2.5)	
8 / 3.5 x 0.6	

0.5...1.5
0.5...1.5 / 0.5...1.5

When using the cross-connection ZQV 2.5N, the rated voltage is reduced to 400V.

Type	Qty.	Order No.
WDK 2.5N	100	1041600000
WDK 2.5N BL	100	1041680000

WDK 2.5N V

2.5 mm²

Both levels on one potential

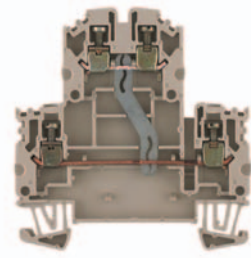

5.1 x 60.7 x 62.5
28 / 4
0.13 ... 4

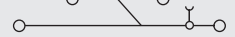

IEC 60947-7-1

EEx e II T II 2 G D

IEC	UL	CSA	EN 50019
800	600	300	550
24	20	20	21
2.5	AWG 26 ...12	AWG 26...12	2.5
8 / 3			
A3 / V-0			



KEMA 00ATEX2061 U

Rated connection	Additional connection
0.5...4 / 1.5...4	
0.5...4 / 0.5...2.5	
0.4...0.6 (M 2.5)	
8 / 3.5 x 0.6	

0.5...1.5
0.5...1.5 / 0.5...1.5

When using the cross-connection ZQV, the rated voltage is reduced to 400V.

Type	Qty.	Order No.
WDK 2.5N V	100	1041610000

Type	Current [A]	Qty.	Order No.
WQV 2.5/2	32	50	1053660000
WQV 2.5/3	32	50	1053760000
WQV 2.5/4	32	50	1053860000
WQV 2.5/10	32	20	1054460000

Current [A]			
WQV 2.5/2	32	50	1053660000
WQV 2.5/3	32	50	1053760000
WQV 2.5/4	32	50	1053860000
WQV 2.5/10	32	20	1054460000

Width [mm]			
WAP 16+35 WTW 2.5-10	1.5	20	1050100000
WAP 16+35 WTW 2.5-10 BL	1.5	20	1050180000

Width [mm]			
EW 35	8.5	50	0383560000
WTA 1 WDU1.5	25		1632290000
WTA 1/ZA WDU1.5	25		1632300000

WAD 4 GE BED	50		1072000000
WAD 4 WS	50		1072100000

WS 12/5 / DEK 5

Socket and test plug see chapter accessories

Type	Current [A]	Qty.	Order No.
ZQV 2.5N/2 GE	24	60	1693800000
ZQV 2.5N/3 GE	24	60	1693810000
ZQV 2.5N/4 GE	24	60	1693820000
ZQV 2.5N/10 GE	24	20	1693880000
ZQV 2.5N/50 GE	24	10	1693890000

Current [A]			
ZQV 2.5N/2 GE	24	60	1693800000
ZQV 2.5N/3 GE	24	60	1693810000
ZQV 2.5N/4 GE	24	60	1693820000
ZQV 2.5N/10 GE	24	20	1693880000
ZQV 2.5N/50 GE	24	10	1693890000

Width [mm]			
WAP WDK2.5/4 N	1.5	20	1084000000
WTW EN	1.5	20	1058800000

Width [mm]			
WEW-35/2	8	100	1061200000

DEK 5 / WS 8/5

Type	Current [A]	Qty.	Order No.
ZQV 2.5N/2 GE	24	60	1693800000
ZQV 2.5N/3 GE	24	60	1693810000
ZQV 2.5N/4 GE	24	60	1693820000
ZQV 2.5N/10 GE	24	20	1693880000
ZQV 2.5N/50 GE	24	10	1693890000

Current [A]			
ZQV 2.5N/2 GE	24	60	1693800000
ZQV 2.5N/3 GE	24	60	1693810000
ZQV 2.5N/4 GE	24	60	1693820000
ZQV 2.5N/10 GE	24	20	1693880000
ZQV 2.5N/50 GE	24	10	1693890000

Width [mm]			
WAP WDK2.5/4 N	1.5	20	1084000000
WTW EN	1.5	20	1058800000

Width [mm]			
WEW-35/2	8	100	1061200000

DEK 5 / WS 8/5

Feed-through terminals

Compact design

The compact design of these protective conductor terminals makes them the obvious choice in confined spaces.

When using ATEX certified components in hazardous area applications the installation instructions and the rated data for accessories in the technical appendix must be considered.

Width/Length/Height with TS35x7.5	mm
Max. current / max. cond. cross-section	A/mm ²
Max. clamping range	mm ²

Technical data

Rated data	
Rated voltage	V
Rated current	A
Rated cross-section	mm ²
Rated impulse voltage / Pollution severity	kV/-
Plug gauge IEC 60-947-1 / flammability class acc. UL94	
Approvals	

Clampable conductors (H05V/H07V)	
Solid / stranded	mm ²
Flexible / flexible w. wire end ferrule	mm ²
Tightening torque range (clamping screw)	Nm
Stripping length / blade size	mm / -

2 clampable conductors of equal cross-section	
Solid / stranded	mm ²
Flexible / flexible w. wire end ferrule	mm ²

Information	
When using the cross-connection ZQV, the rated voltage is reduced to 400V.	

Ordering data

Version	
dark beige Wemid	
blue Wemid	

Information	

Accessories

Cross-connection, pluggable	
	(ZQV 2.5N/4)
	2-pole
	3-pole
	4-pole
	10-pole
	41-/50-pole

Cross-connection, screwable	
	(WQV 2.5-3)
	2-pole
	3-pole
	4-pole
	10-pole

End plate / partition	
End plate	dark beige Wemid blue Wemid
Partition	dark beige Wemid blue Wemid

End bracket	
	dark beige

Testing	
For testing of wired terminal strips	Standard version With spigot

Cover	
	With elec. shock warn. symbol neutral

Marking systems (see large assortment in chapter M)	
	Tags

For detailed information on additional accessories and usage instructions see chapter accessories.

WDK 2.5N DU-PE

2.5 mm²

Lower level earthed on mounting rail

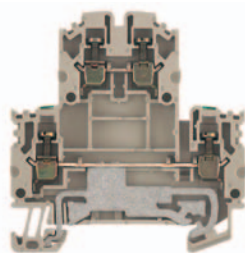

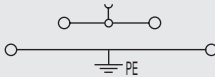
5.1 x 60.7 x 62.5	
28 / 4	
0.13 ... 4	

IEC 60947-7-1 (-7-2) EEx e II T II 2 G D

IEC	UL	CSA	EN 50019
800	600	300	550
24	20	20	21
2.5	AWG 26 ...12	AWG 26...12	2.5
8 / 3			
A3 / V-0			

 KEMA 00ATEX2061 U

Rated connection	Additional connection
0.5...4 / 1.5...4	
0.5...4 / 0.5...2.5	
0.4...0.6 (M 2.5)	
8 / 3.5 x 0.6	

2 clampable conductors of equal cross-section	
Solid / stranded	0.5...1.5
Flexible / flexible w. wire end ferrule	0.5...1.5 / 0.5...1.5

When using the cross-connection ZQV, the rated voltage is reduced to 400V.

Type	Qty.	Order No.
WDK 2.5N DU-PE	100	1041650000

Information		

WDU 4N

4 mm²

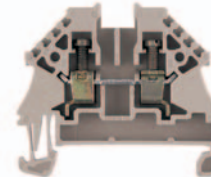

6.1 x 44 x 38.5	
39 / 6	
0.13 ... 6	

IEC 60947-7-1

IEC	UL	CSA	EN 50019
500	300	300	
32	10	10	
4	AWG 26 ...12	AWG 26...10	
6 / 3			
A4 / V-0			



Rated connection	Additional connection
0.5...6 / 1.5...6	
0.5...4 / 0.5...4	
0.5...1.0 (M 3)	
10 / 3.5 x 0.6	

2 clampable conductors of equal cross-section	
Solid / stranded	0.5...1.5
Flexible / flexible w. wire end ferrule	0.5...1.5 / 0.5...1.5

Approval cURus. 2 conductors 1.5mm² solid have to be connected at 0.6 Nm.

Type	Qty.	Order No.
WDU 4N	100	1042600000
WDU 4N BL	100	1042680000

Information		

Type	Current [A]	Qty.	Order No.
ZQV 4N/2	32	60	1758250000
ZQV 4N/3	32	60	1762630000
ZQV 4N/4	32	60	1762620000
ZQV 4N/10	32	20	1758260000
ZQV 4N/41	32	10	1758270000

Current [A]			

Width [mm]			
WAP WDU2.5N/4N	1.5	50	1060000000
WAP WDU2.5N/4N BL	1.5	50	1060080000

Width [mm]			
EW 35	8.5	50	0383560000
WTA 1 WDU1.5		25	1632290000
WTA 1/ZA WDU1.5		25	1632300000

WAD 4 GE BED	50	1072000000
WAD 4 WS	50	1072100000

WS 12/6 / DEK 6		
-----------------	--	--

Feed-through terminals

WDK 4N

4 mm²

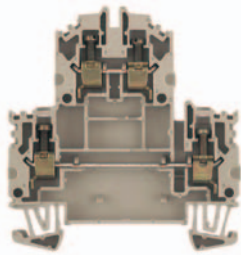

6.1 x 60.7 x 64.1
35 / 6
0.13 ... 6

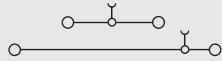

IEC 60947-7-1

EEx e II T II 2 G D

IEC	UL	CSA	EN 50019
800	600	300	550
32	35	30	28
4	AWG 26 ...10	AWG 26...10	4
8 / 3			
A4 / V-0			

KEMA 00ATEX2061 U

Rated connection **Additional connection**

0.5...6 / 1.5...6

0.5...4 / 0.5...4

0.5...1.0 (M3)

8 / 3.5 x 0.6

0.5...1.5

0.5...1.5 / 0.5...1.5

Rated voltage 400V when using cross-connection ZQV
2 conductors 1.5mm² solid have to be connected at 0.6 Nm.

Type	Qty.	Order No.
WDK 4N	100	1041900000
WDK 4N BL	100	1041980000

Type	Current [A]	Qty.	Order No.
ZQV 4N/2	32	60	1758250000
ZQV 4N/3	32	60	1762630000
ZQV 4N/4	32	60	1762620000
ZQV 4N/10	32	20	1758260000
ZQV 4N/41	32	10	1758270000

Current [A]

Width [mm]

WAP WDK2.5/4 N 1.5 20 1084000000

WTW EN 1.5 20 1058800000

Width [mm]

WEW-35/2 8 100 1061200000

DEK 6 / WS 8/5

WDK 4N V

4 mm²

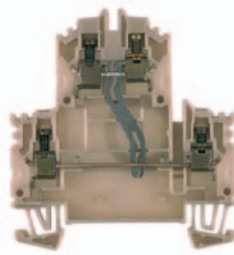

6.1 x 60.7 x 64.1
35 / 6
0.13 ... 6

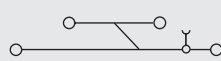

IEC 60947-7-1

EEx e II T II 2 G D

IEC	UL	CSA	EN 50019
800	600	300	550
32	35	30	28
4	AWG 26 ...10	AWG 26...10	4
8 / 3			
A4 / V-0			

KEMA 00ATEX2061 U

Rated connection **Additional connection**

0.5...6 / 1.5...6

0.5...4 / 0.5...4

0.5...1.0 (M3)

8 / 3.5 x 0.6

0.5...1.5

0.5...1.5 / 0.5...1.5

Rated voltage 400V when using cross-connection ZQV
2 conductors 1.5mm² solid have to be connected at 0.6 Nm.

Type	Qty.	Order No.
WDK 4N V	100	1041910000

Type	Current [A]	Qty.	Order No.
ZQV 4N/2	32	60	1758250000
ZQV 4N/3	32	60	1762630000
ZQV 4N/4	32	60	1762620000
ZQV 4N/10	32	20	1758260000
ZQV 4N/41	32	10	1758270000

Current [A]

Width [mm]

WAP WDK2.5/4 N 1.5 20 1084000000

WTW EN 1.5 20 1058800000

Width [mm]

WEW-35/2 8 100 1061200000

DEK 6 / WS 8/5

WDK 4N DU-PE

4 mm²

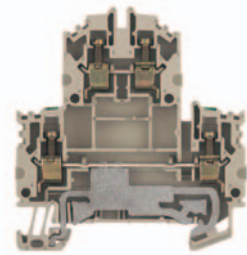

6.1 x 60.7 x 64.1
35 / 6
0.13 ... 6



IEC 60947-7-1 (-7-2)

EEx e II T II 2 G D

IEC	UL	CSA	EN 50019
800	600	300	550
32	35	30	28
4	AWG 26 ...10	AWG 26...10	4
8 / 3			
A4 / V-0			

KEMA 00ATEX2061 U

Rated connection **Additional connection**

0.5...6 / 1.5...6

0.5...4 / 0.5...4

0.5...1.0 (M3)

8 / 3.5 x 0.6

0.5...1.5

0.5...1.5 / 0.5...1.5

Rated voltage 400V when using cross-connection ZQV
2 conductors 1.5mm² solid have to be connected at 0.6 Nm.

Type	Qty.	Order No.
WDK 4N DU-PE	100	1041950000

Type	Current [A]	Qty.	Order No.
ZQV 4N/2	32	60	1758250000
ZQV 4N/3	32	60	1762630000
ZQV 4N/4	32	60	1762620000
ZQV 4N/10	32	20	1758260000
ZQV 4N/41	32	10	1758270000

Current [A]

Width [mm]

WAP WDK2.5/4 N 1.5 20 1084000000

WTW EN 1.5 20 1058800000

Width [mm]

WEW-35/2 8 100 1061200000

DEK 6 / WS 8/5

Feed-through terminals

Compact design

The compact design of these protective conductor terminals makes them the obvious choice in confined spaces.

When using ATEX certified components in hazardous area applications the installation instructions and the rated data for accessories in the technical appendix must be considered.

Width/Length/Height with TS35x7.5	mm
Max. current / max. cond. cross-section	A/mm ²
Max. clamping range	mm ²

Technical data

Rated data	
Rated voltage	V
Rated current	A
Rated cross-section	mm ²
Rated impulse voltage / Pollution severity	kV/-
Plug gauge IEC 60-947-1 / flammability class acc. UL94 Approvals	

Clampable conductors (H05V/H07V)	
Solid / stranded	mm ²
Flexible / flexible w. wire end ferrule	mm ²
Tightening torque range (clamping screw)	Nm
Stripping length / blade size	mm / -

2 clampable conductors of equal cross-section	
Solid / stranded	mm ²
Flexible / flexible w. wire end ferrule	mm ²

Information

Ordering data

Version	
	dark beige Wemid
	blue Wemid

Information

Accessories

Cross-connection, pluggable	
	(ZQV 2.5N/4)
	2-pole
	3-pole
	4-pole
	10-pole
	41-/50-pole

Cross-connection, screwable	
	(WQV 2.5-3)
	2-pole
	3-pole
	4-pole
	10-pole

End plate / partition	
End plate	dark beige Wemid blue Wemid
Partition	dark beige Wemid blue Wemid

End bracket	
	dark beige

Testing	
For testing of wired terminal strips	Standard version With spigot

Cover	
	With elec. shock warn. symbol neutral

Marking systems (see large assortment in chapter M)	
	Tags

For detailed information on additional accessories and usage instructions see chapter accessories.

WDU 16N

16 mm²

Suitable for power distribution

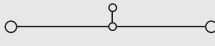

12 x 60 x 47	
101 / 25	
1.5 ... 25	

IEC 60947-7-1

IEC	UL	CSA	EN 50019
690	300	300	
76	70	70	
16	AWG 14 ...6	AWG 14...6	
8 / 3			
B7 / V-0			



Rated connection	Additional connection
1.5...16 / 1.5...25	
1.5...16 / 1.5...16	
1.2...2.4 (M 4)	
12 / 5.5 x 1.0	

2 clampable conductors of equal cross-section	
Solid / stranded	1.5...4
Flexible / flexible w. wire end ferrule	1.5...4 / 1.5...4

25mm² stranded, have to be connected at 2.2 Nm.

Type	Qty.	Order No.
WDU 16N	50	1036100000
WDU 16N BL	50	1036180000

Information

Type	Current [A]	Qty.	Order No.

Current [A]			
WQV 16N/2	76	50	1636560000
WQV 16N/3	57	50	1636570000
WQV 16N/4	57	50	1636580000

Width [mm]			
WTW EN	1.5	20	1058800000

Width [mm]			
WEW-35/2	8	100	1061200000

Width [mm]			
WTA 2 WDU2.5-10		25	1632320000

WAD 12 M. BLITZZEICHEN	50	1055960000	
WAD 12 NEUTRAL	50	1056260000	

WS 12/6,5 / DEK 5

WDU 35N

35 mm²

Suitable for power distribution



16 x 66 x 51	
150 / 50	
2.5 ... 50	

IEC 60947-7-1

IEC	UL	CSA	EN 50019
500	300	300	
125	10	10	
35	AWG 12 ...1	AWG 12...2	
6 / 3			
B8 / V-0			



Rated connection	Additional connection
2.5...16 / 2.5...50	
2.5...35 / 2.5...35	
2.5...5.0 (M 6)	
18 / 6.5 x 1.2	

2 clampable conductors of equal cross-section	
Solid / stranded	2.5...10 / 16...16
Flexible / flexible w. wire end ferrule	2.5...16 / 2.5...16

Type	Qty.	Order No.
WDU 35N	20	1040400000
WDU 35N BL	20	1040480000

Information

Type	Current [A]	Qty.	Order No.

Current [A]			
WQV 35N/2	115	20	1079200000
WQV 35N/3	100	20	1079300000
WQV 35N/4	100	20	1079400000

Width [mm]			
WTW EN	1.5	20	1058800000

Width [mm]			
WEW-35/2	8	100	1061200000

WAD 16N GE BED			1083600000
WAD 16N WS			1083500000

WS 12/6,5 / DEK 5

Feed-through terminals

WDU 50N

50 mm²

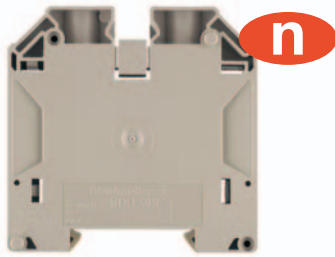

18.5 x 70 x 70
192 / 70
5.26 ... 70

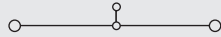

IEC 60947-7-1

IEC	UL	CSA	EN 50019
1000	600		
150	150		
50	AWG 10 ...1/0		
8 / 3			
B10 / V-0			

Rated connection	Additional connection
10...16 / 10...70	
10...50 / 10...50	
3.5...6.0 (hexagon) (M 6)	
24 / S4 (DIN 6911)	

10...16 / 16...16

CSA- and ATEX-approval in preparation.

Type	Qty.	Order No.
WDU 50N	10	1820840000
WDU 50N BL	10	1820850000

Type	Current [A]	Qty.	Order No.
Current [A]			
WQV 50N/2	150	5	1834060000
WQV 50N/3	150	5	1834070000
WQV 50N/4	150	5	1834080000

Width [mm]

Type	Width [mm]	Qty.	Order No.
WEW 35/1	12.2	50	1059000000

WAD 20 GE	10	9512260000
WAD 20 WS	10	9512270000

WS 12/6,5 / DEK 5

Additional auxiliary connection (WZAD) see section accessories W-series Specific functions.

WDU 70N

70 mm²

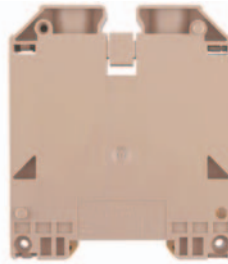

20.5 x 75 x 86
232 / 95
10 ... 95

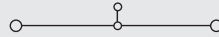

IEC 60947-7-1

EEx e II T II 2 G D

IEC	UL	CSA	EN 50019
1000	600	600	750
192	175	205	167
70	AWG 6 ...2/0		70
8 / 3			
B11 / V-0			



KEMA 98ATEX1683 U

Rated connection	Additional connection
10...16 / 10...95	
10...70 / 10...70	
6.0...10 (hexagon) (M 8)	
22 / S6 (DIN 6911)	

/ 16...16

16...16 / 16...16

Type	Qty.	Order No.
WDU 70N/35	10	9512190000
WDU 70N/35 BL	10	9512420000

Type	Current [A]	Qty.	Order No.
Current [A]			
WQV 70N/2	232	5	9512240000
WQV 70N/3	232	5	9512250000
WQV 70N/4	232	5	9531290000

Width [mm]

Type	Width [mm]	Qty.	Order No.
WEW 35/1	12.2	50	1059000000

WAD 20 GE	10	9512260000
WAD 20 WS	10	9512270000

WS 12/6,5 / DEK 5

Additional auxiliary connection (WZAD) and test plug (PS) see section accessories W-series.

WDU 95N/120N

120 mm²



27 x 91 x 90
290 / 150
16 ... 150

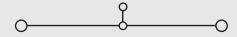

IEC 60947-7-1

IEC	UL	CSA	EN 50019
1000			
269			
120			
8 / 3			
B13 / V-0			

Rated connection	Additional connection
16...16 / 16...150	
16...120 / 16...95	
10...20 (hexagon) (M 10)	
27 / S6 (DIN 6911)	

UL, CSA- and ATEX-approval in preparation.

Type	Qty.	Order No.
WDU 95N/120N	5	1820550000
WDU 95N/120N BL	5	1820560000

Type	Current [A]	Qty.	Order No.
Current [A]			
WQV 95N/120N-2	269	5	1826890000
WQV 95N/120N-3	269	5	1826900000
WQV 95N/120N-4	269	5	1826910000

Width [mm]

Type	Width [mm]	Qty.	Order No.
WEW 35/1	12.2	50	1059000000

WAD 20 GE	10	9512260000
WAD 20 WS	10	9512270000

DEK 5 / WS 12/6,5

Additional auxiliary connection (WZAD) and test plug (PS) see section accessories W-series.

Articles with coloured order number are kept permanently in stock at the central warehouse in Germany. Delivery times see page X.2

PE terminals

Standard design

Identical external profile for the 2.5mm² - 10mm² terminals enables the use of common endplates and partitions thus reducing stocking costs.

When using ATEX certified components in hazardous area applications the installation instructions and the rated data for accessories in the technical appendix must be considered.

Width/Length/Height with TS35x7.5	mm
Max. current / max. cond. cross-section	A/mm ²
Max. clamping range	mm ²

Technical data

Rated data	
Rated cross-section	mm ²
Rated voltage for adjacent terminal	V
Rated impulse voltage for adjacent terminal	kV
Short-time current resistant	A
Pollution severity	
Plug gauge IEC 60-947-1 / flammability class acc. UL94	
Approvals	

Clampable conductors (H05V/H07V)	
Solid / stranded	mm ²
Flexible / flexible w. wire end ferrule	mm ²
Tightening torque range (clamping screw)	Nm
Tightening torque range (fixing screw)	Nm
Stripping length / blade size	mm / -

2 clampable conductors of equal cross-section	
Solid / stranded	mm ²
Flexible / flexible w. wire end ferrule	mm ²

Information

Ordering data

Version	
	green/yellow Wernid

Information

Accessories

End plate	
	dark beige Wernid

End bracket	
	dark beige / beige

Test adapter	
For testing of wired terminal strips	Standard version With spigot

Screwdriver	
	w. cutting device "swifty set" Standard version



Reducing sleeves	
	for conductors < 0.5 mm ² / < AWG 20 for conductors < 1.0 mm ² / < AWG 18

PEN-bridge	
	Insertable in distributor TN-S net between N- and PE-terminal

Marking systems	(see large assortment in chapter M)
	Tags

For detailed information on additional accessories and usage instructions see chapter accessories.

WPE 1.5/ZZ

1.5 mm²

Supplementary connection left and right

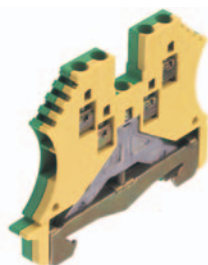

5.1 x 60 x 47
/ 2.5
0.13 ... 2.5

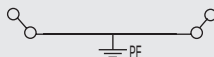

IEC 60947-7-2

EEx e II T II 2 G D

IEC	UL	CSA	EN 50019
1.5	AWG 22 ...14	AWG 26...14	1.5
800			
8			
180 A (1.5mm ²)			
3			
A1 / V-0			



KEMA 98ATEX1685 U

Rated connection	Additional connection
0.5...2.5 / 1.5...2.5	
0.5...1.5 / 0.5...1.5	
0.4...0.6 (M 2.5)	
0.4...0.8 (M 2.5)	
7 / 3.5 x 0.6	

0.5...1	
0.5...1 / 0.5...0.75	

Type	Qty.	Order No.
WPE 1.5/ZZ	100	1016500000

Information

Type	Width [mm]	Qty.	Order No.
WAP 2.5-10	1.5	50	1050000000

	Width [mm]		
WEW-35/2	8	100	1061200000

SD 0.6X3.5X100	10	9008330000
----------------	----	------------

WS 12/5 / DEK 5

Rail support for insulated installation of the mounting rail SH 2 order no. 0494920000 (Qty: 10)

WPE 2.5/1.5/ZR

2.5 mm²

Supplementary connection, right (1.5mm²)



5.1 x 60 x 47
/ 4
0.13 ... 4

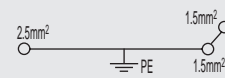

IEC 60947-7-2

EEx e II T II 2 G D

IEC	UL	CSA	EN 50019
2.5	AWG 22 ...12	AWG 26...12	2.5
800			
8			
300 A (2.5 mm ²)			
3			
A3 / V-0			



KEMA 98ATEX1685 U

Rated connection	Additional connection
0.5...4 / 1.5...4	0.5...2.5 / 1.5...2.5
0.5...4 / 0.5...2.5	0.5...1.5 / 0.5...1.5
0.4...0.8 (M 2.5)	0.4...0.6 (M 2.5)
0.4...0.8 (M 2.5)	
10 / 3.5 x 0.6	7 / 3.5 x 0.6

0.5...1.5	0.5...1
0.5...1.5 / 0.5...1.5	0.5...1 / 0.5...0.75

Conductor 2.5 mm² with wire end ferrule with plastic collar only with diameter optimised collar (Order No. 1333100000, Qty. 500)

Type	Qty.	Order No.
WPE 2.5/1.5/ZR	100	1016400000

Information
Technical data for supplementary connection, right (1.5mm ²)

Type	Width [mm]	Qty.	Order No.
WAP 2.5-10	1.5	50	1050000000

	Width [mm]		
WEW-35/2	8	100	1061200000

SD 0.6X3.5X100	10	9008330000
----------------	----	------------

WS 12/5 / DEK 5

Rail support for insulated installation of the mounting rail SH 2 order no. 0494920000 (Qty: 10)

PE terminals

WPE 2.5

2.5 mm²



5.1 x 60 x 47

/ 4

0.13 ... 4

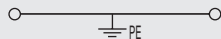

IEC 60947-7-2

EEx e II T II 2 G D

IEC	UL	CSA	EN 50019
2.5	AWG 22 ...12	AWG 26...12	2.5
800			
8			
300 A (2.5 mm ²)			
3			
A3 / V-0			



KEMA 98ATEX1683 U

Rated connection

Additional connection

0.5...4 / 1.5...4

0.5...4 / 0.5...2.5

0.4...0.8 (M 2.5)

0.4...0.8 (M 2.5)

10 / 3.5 x 0.6

0.5...1.5

0.5...1.5 / 0.5...1.5

Conductor 2.5 mm² with wire end ferrule with plastic collar only with diameter optimised collar (Order No. 1333100000, Qty. 500)

WDK 2.5 PE

2.5 mm²

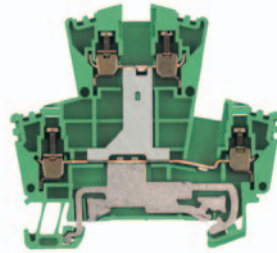

5.1 x 69.5 x 63

/ 4

0.13 ... 4

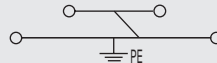

IEC 60947-7-2

EEx e II T II 2 G D

IEC	UL	CSA	EN 50019
2.5	AWG 22 ...12	AWG 26...12	2.5
400			
6			
300 A (2.5 mm ²)			
3			
A3 / V-0			



KEMA 98ATEX1687 U

Rated connection

Additional connection

0.5...4 / 1.5...4

0.5...4 / 0.5...2.5

0.4...0.6 (M 2.5)

10 / 3.5 x 0.6

0.5...1.5

0.5...1.5 / 0.5...1.5

Conductor 2.5 mm² with wire end ferrule with plastic collar only with diameter optimised collar (Order No. 1333100000, Qty. 500)

Type	Qty.	Order No.
WPE 2.5	100	101000000

Type	Qty.	Order No.
WDK 2.5PE	100	1036300000

Type	Width [mm]	Qty.	Order No.
WAP 2.5-10	1.5	50	105000000

Type	Width [mm]	Qty.	Order No.
WAP WDK2.5	1.5	20	1059100000

Width [mm]			
WEW-35/2	8	100	1061200000

Width [mm]			
WEW-35/2	8	100	1061200000

SD 0.6X3.5X100	10	9008330000
----------------	----	------------

SD 0.6X3.5X100	10	9008330000
----------------	----	------------

WS 12/5 / DEK 5

Rail support for insulated installation of the mounting rail SH 2 order no. 0494920000 (Qty. 10)

WS 8/5 / DEK 5

Rail support for insulated installation of the mounting rail SH 2 order no. 0494920000 (Qty. 10)

Articles with coloured order number are kept permanently in stock at the central warehouse in Germany. Delivery times see page X.2

PE terminals

Standard design

Identical external profile for the 2.5mm² - 10mm² terminals enables the use of common endplates and partitions thus reducing stocking costs.

When using ATEX certified components in hazardous area applications the installation instructions and the rated data for accessories in the technical appendix must be considered.

Width/Length/Height with TS35x7.5	mm
Max. current / max. cond. cross-section	A/mm ²
Max. clamping range	mm ²

Technical data

Rated data	
Rated cross-section	mm ²
Rated voltage for adjacent terminal	V
Rated impulse voltage for adjacent terminal	kV
Short-time current resistant	A
Pollution severity	
Plug gauge IEC 60-947-1 / flammability class acc. UL94	
Approvals	

Clampable conductors (H05V/H07V)	
Solid / stranded	mm ²
Flexible / flexible w. wire end ferrule	mm ²
Tightening torque range (clamping screw)	Nm
Tightening torque range (fixing screw)	Nm
Stripping length / blade size	mm / -

2 clampable conductors of equal cross-section	
Solid / stranded	mm ²
Flexible / flexible w. wire end ferrule	mm ²

Information

Ordering data

Version	
	green/yellow Wernid

Information

Accessories

End plate	
	dark beige Wernid

End bracket	
	dark beige / beige

Test adapter	
For testing of wired terminal strips	Standard version With spigot

Screwdriver	
	w. cutting device "swifty set" Standard version



Reducing sleeves	
	for conductors < 0.5 mm ² / < AWG 20 for conductors < 1.0 mm ² / < AWG 18

PEN-bridge	
	Insertable in distributor TN-S net between N- and PE-terminal

Marking systems (see large assortment in chapter M)	
	Tags

For detailed information on additional accessories and usage instructions see chapter accessories.

WPE 4

4 mm²



6.1 x 60 x 47	
/ 6	
0.13 ... 6	

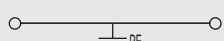

IEC 60947-7-2 EEx e II T II 2 G D

IEC	UL	CSA	EN 50019
4	AWG 22 ...10	AWG 26...10	4
1000			
8			
480 A (4 mm ²)			
3			
A4 / V-0			

KEMA 98ATEX1683 U

Rated connection	Additional connection
0.5...6 / 1.5...6	
0.5...6 / 0.5...4	
0.5...1.0 (M 3)	
0.5...0.8 (M 3)	
10 / 3.5 x 0.6	

0.5...2.5	
0.5...1.5 / 0.5...1.5	

Information

Type	Qty.	Order No.
WPE 4	100	1010100000

Information

Type	Width [mm]	Qty.	Order No.

	Width [mm]		
WEW-35/2	8	100	1061200000

--	--	--	--

SD 0.6X3.5X100		10	9008330000
----------------	--	----	-------------------

--	--	--	--

--	--	--	--

--	--	--	--

Marking systems (see large assortment in chapter M)	
	Tags

Rail support for insulated installation of the mounting rail SH 2 order no. 0494920000 (Qty: 10)

WPE 6

6 mm²



7.9 x 60 x 47	
/ 10	
0.33 ... 10	

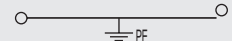

IEC 60947-7-2 EEx e II T II 2 G D

IEC	UL	CSA	EN 50019
6	AWG 22 ...8	AWG 20...8	6
1000			
8			
720 A (6 mm ²)			
3			
A5 / V-0			

KEMA 98ATEX1683 U

Rated connection	Additional connection
0.5...10 / 1.5...10	
0.5...10 / 0.5...6	
0.8...1.6 (M 3.5)	
0.5...1.0 (M 3)	
12 / 4.0 x 0.8	

0.5...2.5	
0.5...2.5 / 0.5...2.5	

Information

Type	Qty.	Order No.
WPE 6	50	1010200000

Information

Type	Width [mm]	Qty.	Order No.

	Width [mm]		
WEW-35/2	8	100	1061200000

--	--	--	--

SD 0.8X4.0X100		10	9008340000
----------------	--	----	-------------------

--	--	--	--

--	--	--	--

--	--	--	--

Marking systems (see large assortment in chapter M)	
	Tags

Rail support for insulated installation of the mounting rail SH 2 order no. 0494920000 (Qty: 10)

PE terminals

WPE 10

10 mm²



9.9 x 60 x 47
/ 16
1.31 ... 16

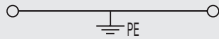

IEC 60947-7-2

EEx e II T II 2 G D

IEC	UL	CSA	EN 50019
10	AWG 16 ...8	AWG 16...6	10
800			
8			
1200 A (10 mm ²)			
3			
B6 / V-0			



KEMA 98ATEX1683 U

Rated connection	Additional connection
1.5...16 / 1.5...16	
1.5...16 / 1.5...16	
1.2...2.4 (M 4)	
0.5...1.0 (M 3)	
12 / 5.5 x 1.0	
1...6	
1...6 / 1...6	

WPE 10/ZR

10 mm²

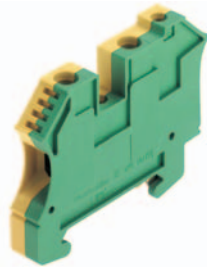

n

9.9 x 70 x 49.5
/ 16
1.31 ... 16

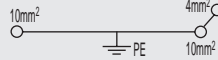

IEC 60947-7-2

IEC	UL	CSA	EN 50019
10	AWG 16 ...6	AWG 14...6	
800			
8			
1200 A (10 mm ²)			
3			
B6 / A4 / V-0			



Rated connection	Additional connection
1.5...16 / 1.5...16	0.5...6 / 1.5...4
1.5...16 / 1.5...16	0.5...4 / 0.5...4
1.2...2.4 (M 4)	0.6...0.8 (M 3)
0.5...1.0 (M 3)	
12 / 5.5 x 1.0	9 / 3.5 x 0.6
1...6	0.5...1.5
1...6 / 1...6	0.5...1.5 / 0.5...1.5

Max. cross-connections refer to 10mm² connections.

Type	Qty.	Order No.
WPE 10	50	1010300000

Type	Qty.	Order No.
WPE 10/ZR	50	1042500000

Type	Width [mm]	Qty.	Order No.
Width [mm]			
WEW-35/2	8	100	1061200000
SD 1.0X5.5X150		10	9008350000
WQB-PEN 10		10	1060300000
WS 12/6,5 / DEK 5			

Rail support for insulated installation of the mounting rail SH 2 order no. 0494920000 (VPE 10)

Type	Width [mm]	Qty.	Order No.
Width [mm]			
WEW-35/2	8	100	1061200000
SD 0.6X3.5X100		10	9008330000
WQB-PEN 10		10	1060300000
WS 12/6,5 / DEK 5			

Rail support for insulated installation of the mounting rail SH 2 order no. 0494920000 (VPE 10)

Articles with coloured order number are kept permanently in stock at the central warehouse in Germany. Delivery times see page X.2

PE terminals

Standard design

Identical external profile for the 2.5mm² - 10mm² terminals enables the use of common endplates and partitions thus reducing stocking costs.

When using ATEX certified components in hazardous area applications the installation instructions and the rated data for accessories in the technical appendix must be considered.

Width/Length/Height with TS35x7.5	mm
Max. current / max. cond. cross-section	A/mm ²
Max. clamping range	mm ²

Technical data

Rated data	
Rated cross-section	mm ²
Rated voltage for adjacent terminal	V
Rated impulse voltage for adjacent terminal	kV
Short-time current resistant	A
Pollution severity	
Plug gauge IEC 60-947-1 / flammability class acc. UL94	
Approvals	

Clampable conductors (H05V/H07V)	
Solid / stranded	mm ²
Flexible / flexible w. wire end ferrule	mm ²
Tightening torque range (clamping screw)	Nm
Tightening torque range (fixing screw)	Nm
Stripping length / blade size	mm / -

2 clampable conductors of equal cross-section	
Solid / stranded	mm ²
Flexible / flexible w. wire end ferrule	mm ²

Information
TS 35x15 (steel, thickness 1.5mm) has to be used for cross-connections of 25 mm ² (see chapter F).

Ordering data

Version
green/yellow Wernid

Information

Accessories

End plate
dark beige Wernid

End bracket
dark beige / beige

Test adapter
For testing of wired terminal strips
Standard version
With spigot

Screwdriver
w. cutting device "swifty set"
Standard version



Reducing sleeves
for conductors < 0.5 mm ² / < AWG 20
for conductors < 1.0 mm ² / < AWG 18

PEN-bridge
Insertable in distributor TN-S net between N- and PE-terminal

Marking systems (see large assortment in chapter M)
Tags

For detailed information on additional accessories and usage instructions see chapter accessories.

WPE 16

16 mm²

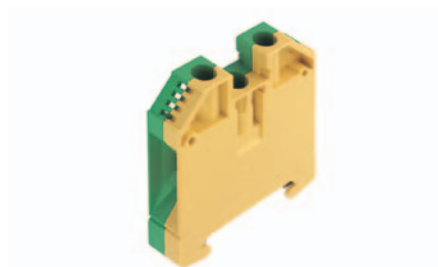

11.9 x 60 x 63
/ 25
1.5 ... 25

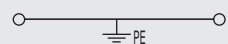

IEC 60947-7-2 EEx e II Ex T II 2 G D

IEC	UL	CSA	EN 50019
16	AWG 14 ...6	AWG 14...6	16
1000			
8			
1920 A (16mm ²)			
3			
B7 / V-0			

KEMA 98ATEX1683 U

Rated connection	Additional connection
1.5...16 / 1.5...25	
1.5...25 / 1.5...16	
2.0...4.0 (M 5)	
1.2...2.4 (M 4)	
16 / 5.5 x 1.0	

1.5...6
1.5...6 / 1.5...6

TS 35x15 (steel, thickness 1.5mm) has to be used for cross-connections of 25 mm² (see chapter F).

Type	Qty.	Order No.
WPE 16	50	1010400000

Information

Type	Width [mm]	Qty.	Order No.

Type	Width [mm]	Qty.	Order No.
WEW 35/1	12.2	50	1059000000

Type	Qty.	Order No.

Type	Qty.	Order No.
SD 1.0X5.5X150	10	9008350000

Type	Qty.	Order No.

Type	Qty.	Order No.
WQB-PEN 16	10	1060200000

Type	Qty.	Order No.
WS 12/6,5 / DEK 5		

Rail support for insulated installation of the mounting rail SH 2 order no. 0494920000 (Qty: 10)

WPE 35

35 mm²

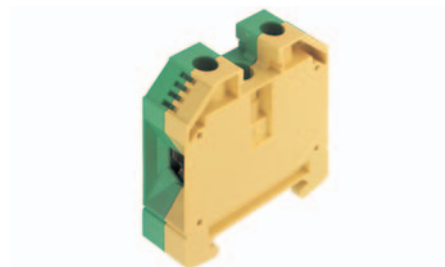

16 x 60 x 63
/ 35
2.5 ... 35

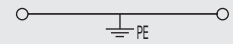

IEC 60947-7-2 EEx e II Ex

IEC	UL	CSA	EN 50019
35	AWG 12 ...2	AWG 12...2	35
800			
8			
4200 A (35mm ²)			
3			
B8 / V-0			

KEMA 98ATEX1683 U

Rated connection	Additional connection
2.5...16 / 2.5...50	
2.5...35 / 2.5...35	
2.5...5.0 (M 6)	
1.2...2.4 (M 4)	
18 / 6.5 x 1.2	

2.5...10 / 16...16
2.5...16 / 2.5...16

TS 35x15 (steel, thickness 1.5mm) has to be used for 35 mm². TS 35x15 (steel, thickness 2.3 mm) has to be used for 50 mm². (see chapter F).

Type	Qty.	Order No.
WPE 35	25	1010500000

Information
Conductor 50mm ² , stranded, must be connected with 4Nm

Type	Width [mm]	Qty.	Order No.

Type	Width [mm]	Qty.	Order No.
WEW 35/1	12.2	50	1059000000

Type	Qty.	Order No.

Type	Qty.	Order No.
SD 1.2x6.5x150	10	9009010000

Type	Qty.	Order No.

Type	Qty.	Order No.
WQB-PEN 35	10	1060100000

Type	Qty.	Order No.
WS 12/6,5 / DEK 5		

Rail support for insulated installation of the mounting rail SH 2 order no. 0494920000 (Qty: 10)

PE terminals

WPE 70/95

95 mm²

WPE 120/150

120 mm²

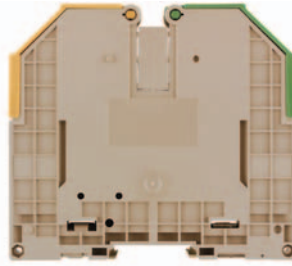
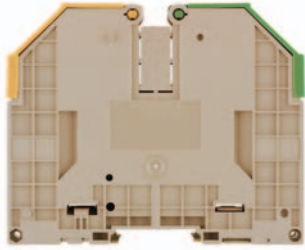

27 x 132 x 108
/ 120
13.3 ... 120

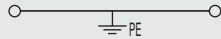

32 x 132 x 118
/ 150
33.62 ... 150

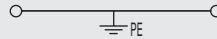

IEC 60947-7-2 EEx e II T II 2 G D

IEC 60947-7-2 EEx e II T II 2 G D

IEC	UL	CSA	EN 50019
95	AWG 6 ...2/0	AWG 6...2/0	95
1000			
8			
11400 A (95mm ²)			
3			
B12 / V-0			

IEC	UL	CSA	EN 50019
120	AWG 2 ...250 kcmil	AWG 2...250 kcmil	120
1000			
8			
14400 A (120mm ²)			
3			
B13 / V-0			

KEMA 98ATEX1686 U

KEMA 98ATEX1686 U

Rated connection	Additional connection
16...16 / 16...120	
16...95 / 16...95	
6.0...12 (hexagon) (M 8)	
3.0...6.0 (M 6)	
30 / S6 (DIN 6911)	

Rated connection	Additional connection
/ 35...150	
35...150 / 35...95	
10...20 (hexagon) (M 10)	
3.0...6.0 (M 6)	
35 / S6 (DIN 6911)	

16...16 / 16...35
16...35 / 16...35

/ 35...70
35...70 / 35...70

TS 35x15 (copper, thickness 2.3mm) has to be used for cross-connections of 70-150 mm² (see chapter F).

TS 35x15 (copper, thickness 2.3mm) has to be used for cross-connections of 70-150 mm².

Type	Qty.	Order No.
WPE 70/95	10	1037300000

Type	Qty.	Order No.
WPE 120	10	1019700000

95 and 120mm² must be connected with at least 10Nm

Type	Width [mm]	Qty.	Order No.
Width [mm]			
WEW 35/1	12.2	50	1059000000
WQV 70/95-PEN		5	1072300000

Type	Width [mm]	Qty.	Order No.
Width [mm]			
WEW 35/1	12.2	50	1059000000
WQV 120-PEN		5	1072400000

WS 12/6,5 / DEK 5

WS 12/6,5 / DEK 5

Rail support for insulated installation of the mounting rail SH 2 order no. 0494920000 (Qty. 10)

Rail support for insulated installation of the mounting rail SH 2 order no. 0494920000 (Qty. 10)

Articles with coloured order number are kept permanently in stock at the central warehouse in Germany. Delivery times see page X.2

PE terminals

Compact design

The compact design of these protective conductor terminals makes them the obvious choice in confined spaces.

When using ATEX certified components in hazardous area applications the installation instructions and the rated data for accessories in the technical appendix must be considered.

Width/Length/Height with TS35x7.5	mm
Max. current / max. cond. cross-section	A/mm ²
Max. clamping range	mm ²

Technical data

Rated data	
Rated cross-section	mm ²
Rated voltage for adjacent terminal	V
Rated impulse voltage for adjacent terminal	kV
Short-time current resistant	A
Pollution severity	
Plug gauge IEC 60-947-1 / flammability class acc. UL94	
Approvals	

Clampable conductors (H05V/H07V)	
Solid / stranded	mm ²
Flexible / flexible w. wire end ferrule	mm ²
Tightening torque range (clamping screw)	Nm
Tightening torque range (fixing screw)	Nm
Stripping length / blade size	mm / -

2 clampable conductors of equal cross-section	
Solid / stranded	mm ²
Flexible / flexible w. wire end ferrule	mm ²

Information
Conductor 2.5 mm ² with wire end ferrule with plastic collar only with diameter optimised collar (Order No. 1333100000, Qty. 500)

Ordering data

Version
green/yellow Wernid

Information

Accessories

End plate
dark beige Wernid

End bracket
dark beige / beige

Test adapter
For testing of wired terminal strips
Standard version
With spigot

Screwdriver
w. cutting device "swifty set"
Standard version

Reducing sleeves
for conductors < 0.5 mm ² / < AWG 20
for conductors < 1.0 mm ² / < AWG 18

PEN-bridge
Insertable in distributor TN-S net between N- and PE-terminal

Marking systems (see large assortment in chapter M)
Tags

For detailed information on additional accessories and usage instructions see chapter accessories.

WPE 2.5N

2.5 mm²



5.1 x 44 x 37.5
/ 4
0.13 ... 4

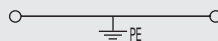

IEC 60947-7-2 EEx e II T II 2 G D

IEC	UL	CSA	EN 50019
2.5	AWG 26 ...12	AWG 26...12	2.5
		500	
		6	
		300 A (2.5 mm ²)	
		3	
	A3 / V-0		

KEMA 98ATEX1683 U

Rated connection	Additional connection
0.5...4 / 1.5...4	
0.5...4 / 0.5...2.5	
0.4...0.6 (M 2.5)	
0.4...0.8 (M 2.5)	
10 / 3.5 x 0.6	

0.5...1.5
0.5...1.5 / 0.5...1.5

Conductor 2.5 mm² with wire end ferrule with plastic collar only with diameter optimised collar (Order No. 1333100000, Qty. 500)

WDK 2.5N PE

2.5 mm²

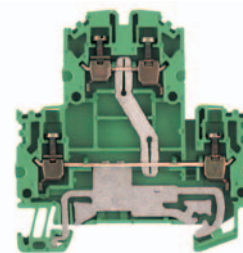

5.1 x 60.7 x 62.5
/ 4
0.13 ... 4

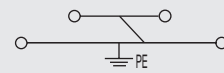

IEC 60947-7-2 EEx e II T II 2 G D

IEC	UL	CSA	EN 50019
2.5	AWG 26 ...12	AWG 26...12	2.5
		800	
		8	
		300 A (2.5 mm ²)	
		3	
	A3 / V-0		

KEMA 00ATEX2061 U

Rated connection	Additional connection
0.5...4 / 1.5...4	
0.5...4 / 0.5...2.5	
0.4...0.6 (M 2.5)	
8 / 3.5 x 0.6	

0.5...1.5
0.5...1.5 / 0.5...1.5

Conductor 2.5 mm² with wire end ferrule with plastic collar only with diameter optimised collar (Order No. 1333100000, Qty. 500)

Type	Qty.	Order No.
WPE 2.5N	100	1016200000

Type	Qty.	Order No.
WDK 2.5N PE	100	1041620000

Type	Width [mm]	Qty.	Order No.
WAP WDU2.5N/4N	1.5	50	1060000000

Type	Width [mm]	Qty.	Order No.
WAP WDK2.5/4 N	1.5	20	1084000000

Type	Width [mm]	Qty.	Order No.
EW 35	8.5	50	0383560000

Type	Width [mm]	Qty.	Order No.
WEW-35/2	8	100	1061200000

Type	Width [mm]	Qty.	Order No.
SD 0.6X3.5X100		10	9008330000

Type	Width [mm]	Qty.	Order No.
SD 0.6X3.5X100		10	9008330000

Type	Width [mm]	Qty.	Order No.
SD 0.6X3.5X100		10	9008330000

Rail support for insulated installation of the mounting rail SH 2 order no. 0494920000 (Qty. 10)

PE terminals

WPE 4N

4 mm²

WDK 4N PE

4 mm²

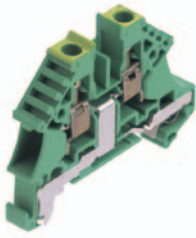

n

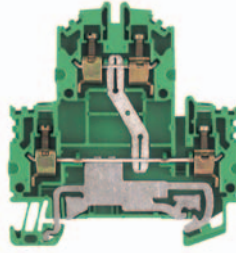

6.1 x 44 x 38.5
/ 6
0.13 ... 6

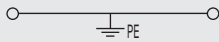

6.1 x 60.7 x 64.1
/ 6
0.13 ... 6

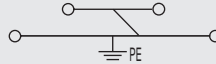

IEC 60947-7-2

IEC	UL	CSA	EN 50019
4	AWG 26 ...10	AWG 26...10	
		500	
		6	
		480 A (4 mm ²)	
		3	
		A3 / V-0	

UL

Rated connection	Additional connection
0.5...6 / 1.5...6	
0.5...4 / 0.5...4	
0.5...1.0 (M3)	

10 / 3.5 x 0.6

0.5...1.5

0.5...1.5 / 0.5...1.5

IEC 60947-7-2

EEx e II T II 2 G D

IEC	UL	CSA	EN 50019
4	AWG 26 ...10	AWG 26...10	4
		800	
		8	
		480 A (4 mm ²)	
		3	
		A3 / V-0	

UL

KEMA 00ATEX2061 U

Rated connection	Additional connection
0.5...6 / 1.5...6	
0.5...4 / 0.5...4	
0.5...1.0 (M3)	

8 / 3.5 x 0.6

0.5...1.5

0.5...1.5 / 0.5...1.5

Type	Qty.	Order No.
WPE 4N	100	1042700000

Type	Qty.	Order No.
WDK 4N PE	100	1041920000

Type	Width [mm]	Qty.	Order No.
WAP WDU2.5N/4N	1.5	50	1060000000

Type	Width [mm]	Qty.	Order No.
WAP WDK2.5/4 N	1.5	20	1084000000

Type	Width [mm]	Qty.	Order No.
EW 35	8.5	50	0383560000

Type	Width [mm]	Qty.	Order No.
WEW-35/2	8	100	1061200000

SD 0.6X3.5X100	10	9008330000
----------------	----	------------

SD 0.6X3.5X100	10	9008330000
----------------	----	------------

DEK 6 / WS 12/6

Rail support for insulated installation of the mounting rail SH 2 order no. 0494920000 (Qty:1)

DEK 6 / WS 8/5

Rail support for insulated installation of the mounting rail SH 2 order no. 0494920000 (Qty: 10)

Articles with coloured order number are kept permanently in stock at the central warehouse in Germany. Delivery times see page X.2

PE terminals

Compact design

The compact design of these protective conductor terminals makes them the obvious choice in confined spaces.

When using ATEX certified components in hazardous area applications the installation instructions and the rated data for accessories in the technical appendix must be considered.

Width/Length/Height with TS35x7.5	mm
Max. current / max. cond. cross-section	A/mm ²
Max. clamping range	mm ²

Technical data

Rated data

Rated cross-section	mm ²
Rated voltage for adjacent terminal	V
Rated impulse voltage for adjacent terminal	kV
Short-time current resistant	A
Pollution severity	
Plug gauge IEC 60-947-1 / flammability class acc. UL94	
Approvals	

Clampable conductors (H05V/H07V)

Solid / stranded	mm ²
Flexible / flexible w. wire end ferrule	mm ²
Tightening torque range (clamping screw)	Nm
Tightening torque range (fixing screw)	Nm
Stripping length / blade size	mm / -

2 clampable conductors of equal cross-section

Solid / stranded	mm ²
Flexible / flexible w. wire end ferrule	mm ²

Information

Ordering data

Version	green/yellow Wernid
----------------	---------------------

Information

Accessories

End plate	dark beige Wernid
------------------	-------------------

End bracket	dark beige / beige
--------------------	--------------------

Test adapter

For testing of wired terminal strips	Standard version
	With spigot

Screwdriver

w. cutting device "swifty set"	
	Standard version

Reducing sleeves

for conductors < 0.5 mm² / < AWG 20
for conductors < 1.0 mm² / < AWG 18

PEN-bridge

Insertable in distributor TN-S net between N- and PE-terminal

Marking systems (see large assortment in chapter M)

Tags

For detailed information on additional accessories and usage instructions see chapter accessories.

WPE 16N

16 mm²



12 x 60 x 47
/ 25
1.5 ... 25

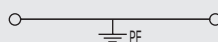

IEC 60947-7-2

IEC	UL	CSA	EN 50019
16	AWG 14 ...6	AWG 14...6	
		400	
		6	
		1920 A (16mm ²)	
		3	
		B7 / V-0	



Rated connection

1.5...16 / 1.5...25
1.5...16 / 1.5...16
1.2...2.4 (M 4)
0.5...1.0 (M 3)
12 / 5.5 x 1.0

Additional connection

1.5...4
1.5...4 / 1.5...4

25mm² stranded, have to be connected at 2.2 Nm.

WPE 35N

35 mm²



16 x 66 x 51
/ 50
2.5 ... 50

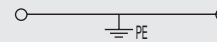

IEC 60947-7-2

IEC	UL	CSA	EN 50019
35			
		400	
		6	
		4200 A (35mm ²)	
		3	
		B8 / V-0	



Rated connection

2.5...16 / 2.5...50
2.5...35 / 2.5...35
2.5...5.0 (M 6)
1.2...2.4 (M 4)
18 / 6.5 x 1.2

Additional connection

2.5...10 / 16...16
2.5...16 / 2.5...16

TS 35x15 (steel, thickness 1.5mm) has to be used for 35 mm². TS 35x15 (steel, thickness 2.3 mm) has to be used for 50 mm².

Type	Qty.	Order No.
WPE 16N	50	1019100000

--	--	--

Type	Width [mm]	Qty.	Order No.

Width [mm]			
WEW-35/2	8	100	1061200000

--	--	--	--

--	--	--	--

SD 1.0X5.5X150	10	9008350000
----------------	----	------------

--	--	--

--	--	--

WQV 16N-PEN GN	10	1071350000
----------------	----	------------

WS 12/6,5 / DEK 5		
-------------------	--	--

Rail support for insulated installation of the mounting rail SH 2 order no. 0494920000 (Qty: 10)

Type	Qty.	Order No.
WPE 35N	20	1717740000

--	--	--

Type	Width [mm]	Qty.	Order No.

Width [mm]			
WEW-35/2	8	100	1061200000

--	--	--	--

--	--	--	--

SD 1.2x6.5x150	10	9009010000
----------------	----	------------

--	--	--

WQV 16N-PEN BL	10	1071360000
----------------	----	------------

DEK 8 / WS 12/6,5		
-------------------	--	--

Rail support for insulated installation of the mounting rail SH 2 order no. 0494920000 (Qty: 10)

PE terminals

WPE 50N

50 mm²

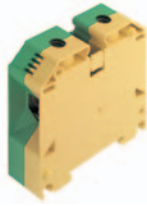

18.5 x 70 x 70
/ 70
10 ... 70

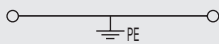

IEC 60947-7-2

IEC	UL	CSA	EN 50019
50			
	1000		
	8		
	6000 A (50mm ²)		
	3		
	B10 / V-0		

Rated connection	Additional connection
10...16 / 10...70	
10...50 / 10...50	
3.5...6.0 (hexagon) (M 6)	
2.0...4.0 (M 5)	
24 / S4 (DIN 6911)	

10...16 / 16...16

TS 35x15 (copper, thickness 2.3 mm) has to be used for cross sections over 50 mm².

Type	Qty.	Order No.
WPE 50N	10	1846040000

UL, CSA- and ATEX-approval in preparation.

WPE 70N/35

70 mm²

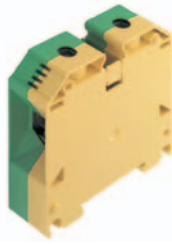

20.5 x 75 x 86
/ 95
10 ... 95

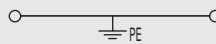

IEC 60947-7-2

EEx e II T II 2 G D

IEC	UL	CSA	EN 50019
70	AWG 6 ...2/0	AWG 6...2/0	70
	1000		
	8		
	8400 A (70mm ²)		
	3		
	B11 / V-0		



KEMA 98ATEX1683 U

Rated connection	Additional connection
10...16 / 10...95	
10...70 / 10...70	
6.0...10 (hexagon) (M 8)	
2.0...4.0 (M 5)	
22 / S6 (DIN 6911)	

/ 16...16
16...16 / 16...16

TS 35x15 (copper, thickness 2.3mm) has to be used for cross sections of 70-150 mm².

Type	Qty.	Order No.
WPE 70N/35	10	9512200000

UL, CSA- and ATEX-approval in preparation.

WPE 95N/120N

95 mm²



27 x 91 x 90
/ 150
16 ... 150

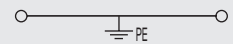

IEC 60947-7-2

IEC	UL	CSA	EN 50019
95			
	1000		
	8		
	11400 A (95mm ²)		
	3		
	B13 / V-0		

Rated connection	Additional connection
16...16 / 16...150	
16...120 / 16...95	
10...20 (hexagon) (M 10)	
2.0...4.0 (M 5)	
27 / S6 (DIN 6911)	

16...16 / 16...16

TS 35x15 (copper, thickness 2.3mm) has to be used for cross sections of 70-150 mm².

Type	Qty.	Order No.
WPE 95N/120N	5	1846030000

UL, CSA- and ATEX-approval in preparation.

Type	Width [mm]	Qty.	Order No.
Width [mm]			
WEW 35/1	12.2	50	1059000000

WS 12/6,5 / DEK 5

Rail support for insulated installation of the mounting rail SH 2 order no. 0494920000 (Qty. 10)

Type	Width [mm]	Qty.	Order No.
Width [mm]			
WEW 35/1	12.2	50	1059000000
WQV 70N-PEN		5	9525840000

WS 12/6,5 / DEK 8

Rail support for insulated installation of the mounting rail SH 2 order no. 0494920000 (Qty. 10). Aux. connection (WZAD) see section accessories.

Type	Width [mm]	Qty.	Order No.
Width [mm]			
WEW 35/1	12.2	50	1059000000

WS 12/6,5 / DEK 5

Rail support for insulated installation of the mounting rail SH 2 order no. 0494920000 (Qty. 10)

Articles with coloured order number are kept permanently in stock at the central warehouse in Germany. Delivery times see page X.2

Disconnect terminals

Disconnect terminals

With disconnect terminals the current can quickly and safely be cut to carry our essential maintenance.

When using ATEX certified components in hazardous area applications the installation instructions and the rated data for accessories in the technical appendix must be considered.

Width/Length/Height with TS35x7.5	mm
Max. current / max. cond. cross-section	A/mm ²
Max. clamping range	mm ²

Technical data

Rated data	
Rated voltage feed through terminal	V
Rated current	A
Rated cross-section	mm ²
Rated impulse voltage / Pollution severity	kV/-
Plug gauge IEC 60-947-1 / flammability class acc. UL94	
Approvals	

Clampable conductors (H05V/H07V)

Solid / stranded	mm ²
Flexible / flexible w. wire end ferrule	mm ²
Tightening torque range (clamping screw)	Nm
Stripping length / blade size	mm / -

2 clampable conductors of equal cross-section

Solid / stranded	mm ²
Flexible / flexible w. wire end ferrule	mm ²

Information

Ordering data

Version	
	dark beige Wernid
	blue Wernid
	Without disconnecter, dark beige Wernid

Information

Accessories

Cross-connection, pluggable

	2-pole
	3-pole
	4-pole
	10-pole

(ZQV 2.5N/4)

End plate / partition

End plate	dark beige Wernid
	blue Wernid
Partition	dark beige Wernid

End bracket

	dark beige / beige
--	--------------------

Screwdriver

	w. cutting device "swifty set"
	Standard version

Holder for fuse cartridges 5 x 20mm

	400V ac/dc. without LED
	10 - 36V ac/dc. red LED
	140 - 250V ac/dc. red LED

Diode plug (up to 250V)

	Polarity when insert on terminal	+ -
	(WSD 2.5) Without special components	- +

Marking systems (see large assortment in chapter M)

	Tags
--	------

For detailed information on additional accessories and usage instructions see chapter accessories.

WTR 2.5

2.5 mm²

With clamping screw

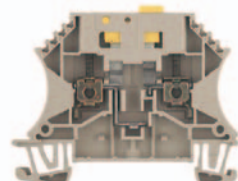

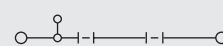
5.1 x 60 x 49	
14 / 4	
0.13 ... 4	

IEC 60947-7-1 / VDE 0100-537

IEC	UL	CSA	EN 50019
800	300	300	
14	10	10	
2.5	AWG 22 ...12	AWG 26...12	
		8 / 3	
		A3 / V-0	



Rated connection

0.5...4 / 1.5...4
0.5...4 / 0.5...2.5
0.4...0.6 (M 2.5)
10 / 3.5 x 0.6

0.5...1.5
0.5...1.5 / 0.5...1.5

500V as disconnect terminal. Conductor 2.5 mm² with wire end ferrule with plastic collar only with Order No. 1333100000, Qty. 500

Type	Qty.	Order No.
WTR 2.5	100	1011100000
WTR 2.5 BL	100	1011180000
WTR 2.5/D/O.TNHE	100	1012900000

Versions with socket 2.0 on request. Colour versions see section Accessories W-series Specific functions

Type	Current [A]	Qty.	Order No.

Width [mm]			
WAP 2.5-10	1.5	50	1050000000
WAP 2.5-10 BL	1.5	50	1050080000
WAP 16+35 WTW 2.5-10	1.5	20	1050100000

Width [mm]			
WEW-35/2	8	100	1061200000

SD 0.6X3.5X100	10	9008330000
----------------	----	------------

SIHA 1/G20	25	9537550000
SIHA 1/G20 10-36V	25	9537560000
SIHA 1/G20 140-250V	25	9537590000

WSD 2.5/D+/- WTR2.5	25	1058460000
WSD 2.5/D-/+ WTR2.5	25	1058560000
WSD 2.5/SCAN WTR2.5	25	1058760000

WS 12/5 / DEK 5

Special cross-connections see section accessories W-series

WTR 2.5 StB

2.5 mm²

With socket

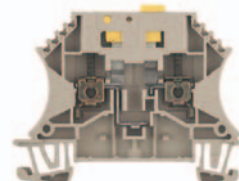

5.1 x 60 x 49	
14 / 4	
0.13 ... 4	

IEC 60947-7-1 / VDE 0100-537

IEC	UL	CSA	EN 50019
800	300	300	
14	10	10	
2.5	AWG 22 ...12	AWG 26...12	
		8 / 3	
		A3 / V-0	



Rated connection

0.5...4 / 1.5...4
0.5...4 / 0.5...2.5
0.5...0.6 (M 2.5)
10 / 3.5 x 0.6

0.5...1.5
0.5...1.5 / 0.5...1.5

500V as isolating terminal. Conductor 2.5 mm² with wire end ferrule with plastic collar only with Order No. 1333100000, Qty. 500

Type	Qty.	Order No.
WTR 2.5 STB2.3	100	1011200000
WTR 2.5 STB2.3 BL	100	1011280000
WTR 2.5/O.TNHE STB2.3	100	1012800000

Versions with socket 2.0 on request

Type	Current [A]	Qty.	Order No.

Width [mm]			
WAP 2.5-10	1.5	50	1050000000
WAP 2.5-10 BL	1.5	50	1050080000
WAP 16+35 WTW 2.5-10	1.5	20	1050100000

Width [mm]			
WEW-35/2	8	100	1061200000

SD 0.6X3.5X100	10	9008330000
----------------	----	------------

SIHA 1/G20	25	9537550000
SIHA 1/G20 10-36V	25	9537560000
SIHA 1/G20 140-250V	25	9537590000

WSD 2.5/D+/- WTR2.5	25	1058460000
WSD 2.5/D-/+ WTR2.5	25	1058560000
WSD 2.5/SCAN WTR2.5	25	1058760000

DEK 5 / WS 12/5

Special cross-connections see section accessories W-series

Disconnect terminals

WTR 2.5 D

2.5 mm²

With diode plug

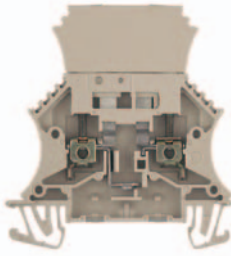

5.1 x 60 x 64.7
14 / 4
0.13 ... 4

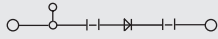

IEC 60947-7-1 / VDE 0100-537

IEC	UL	CSA	EN 50019
500	300	300	
14	10	10	
2.5	AWG 22 ...12	AWG 26...12	
6 / 3			
A3 / V-0			



Rated connection

0.5...4 / 1.5...4
0.5...4 / 0.5...2.5
0.4...0.6 (M 2.5)
10 / 3.5 x 0.6

0.5...1.5
0.5...1.5 / 0.5...1.5

Conductor 2.5 mm² with wire end ferrule with plastic collar only with diameter optimised collar (Order No. 1333100000, Qty. 500)

Type	Qty.	Order No.
WTR 2.5/D+	25	1013500000

Order No. 1013600000 WTR 2.5D-/+; Version with socket Order No. 1013200000 (+/-) and 1013300000 (-/+)

Type	Current [A]	Qty.	Order No.

Width [mm]			
WAP 2.5-10	1.5	50	1050000000
WAP 2.5-10 BL	1.5	50	1050080000
WAP 16+35 WTW 2.5-10	1.5	20	1050100000

Width [mm]			
WEW-35/2	8	100	1061200000

SD 0.6X3.5X100	10	9008330000
----------------	----	------------

SIHA 1/G20	25	9537550000
SIHA 1/G20 10-36V	25	9537560000
SIHA 1/G20 140-250V	25	9537590000

WSD 2.5/D+/- WTR2.5	25	1058460000
WSD 2.5/D-/+ WTR2.5	25	1058560000
WSD 2.5/SCAN WTR2.5	25	1058760000

WS 12/5 / DEK 5

Special cross-connections see section accessories W-series

WTR 2.5/ZZ

2.5 mm²

Supplementary connection left and right

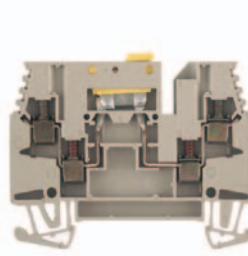

5.1 x 60 x 49
14 / 4
0.13 ... 4

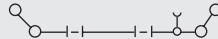

IEC 60947-7-1 / VDE 0100-537

IEC	UL	CSA	EN 50019
400	300	300	
14	10	10	
2.5	AWG 26 ...12	AWG 26...12	
6 / 3			
A3 / V-0			



Rated connection

0.5...4 / 1.5...4
0.5...4 / 0.5...2.5
0.5...0.6 (M 3)
7 / 3.5 x 0.6

0.5...1.5
0.5...1.5 / 0.5...1.5

Type	Qty.	Order No.
WTR 2.5/ZZ	100	1039900000
WTR 2.5/ZZ BL	100	1039980000

Conductor 2.5 mm² with wire end ferrule with plastic collar only with diameter optimised collar (Order No. 1333100000, Qty. 500)

Type	Current [A]	Qty.	Order No.
ZQV 2.5/2	24	60	1608860000
ZQV 2.5/3	24	60	1608870000
ZQV 2.5/4	24	60	1608880000
ZQV 2.5/10	24	20	1608940000

Width [mm]			
WAP WTR2.5/ZZ	1.5	20	1074600000
WAP WTR2.5/ZZ BL	1.5	20	1074680000

Width [mm]			
WEW-35/2	8	100	1061200000

SD 0.6X3.5X100	10	9008330000
----------------	----	------------

SIHA 1/G20	25	9537550000
SIHA 1/G20 10-36V	25	9537560000
SIHA 1/G20 140-250V	25	9537590000

WSD 2.5/D+/- WTR2.5	25	1058460000
WSD 2.5/D-/+ WTR2.5	25	1058560000
WSD 2.5/SCAN WTR2.5	25	1058760000

DEK 5 / WS 12/5

WDTR 2.5

2.5 mm²

Double-terminal



6.2 x 94 x 69
14 / 4
0.13 ... 4

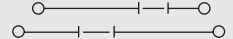

IEC 60947-7-1 / VDE 0100-537

IEC	UL	CSA	EN 50019
400			
10			
2.5			
4 / 3			
A3 / V-0			



Rated connection

0.5...4 / 1.5...4
0.5...2.5 / 0.5...2.5
0.5...0.6 (M 3)
8 / 3.5 x 0.6

0.5...1.5
0.5...1.5 / 0.5...1.5

Type	Qty.	Order No.
WDTR 2.5	25	9528070000
WDTR 2.5 BL	25	9528080000

Order No. 9528090000 and 9528100000 (blue) all connections on one potential; Connections: 2x left, 1x right

Type	Current [A]	Qty.	Order No.

Width [mm]			

Width [mm]			
WEW-35/2	8	100	1061200000

SD 0.6X3.5X100	10	9008330000
----------------	----	------------

--	--	--	--

WSD 2.5/D+/- WTR2.5	25	1058460000
WSD 2.5/D-/+ WTR2.5	25	1058560000
WSD 2.5/SCAN WTR2.5	25	1058760000

DEK 6 / WS 8/5

Cross-connection only possible on the outside (on request)

Disconnect terminals

Disconnect terminals

With disconnect terminals the current can quickly and safely be cut to carry our essential maintenance.

When using ATEX certified components in hazardous area applications the installation instructions and the rated data for accessories in the technical appendix must be considered.

Width/Length/Height with TS35x7.5	mm
Max. current / max. cond. cross-section	A/mm ²
Max. clamping range	mm ²

Technical data

Rated data	
Rated voltage feed through terminal	V
Rated current	A
Rated cross-section	mm ²
Rated impulse voltage / Pollution severity	kV/-
Plug gauge IEC 60-947-1 / flammability class acc. UL94	
Approvals	

Clampable conductors (H05V/H07V)	
Solid / stranded	mm ²
Flexible / flexible w. wire end ferrule	mm ²
Tightening torque range (clamping screw)	Nm
Stripping length / blade size	mm / -

2 clampable conductors of equal cross-section	
Solid / stranded	mm ²
Flexible / flexible w. wire end ferrule	mm ²

Information

Ordering data

Version	
dark beige Wernid	
blue Wernid	
Without disconnecter, dark beige Wernid	

Information

Accessories

Cross-connection, pluggable	
	2-pole
	3-pole
	4-pole
	10-pole

End plate / partition	
End plate	dark beige Wernid
	blue Wernid
Partition	dark beige Wernid

End bracket	
	dark beige / beige

Screwdriver	
	w. cutting device "swifty set"
	Standard version

Holder for fuse cartridges 5 x 20mm	
	400V ac/dc. without LED
	10 - 36V ac/dc. red LED
	140 - 250V ac/dc. red LED

Diode plug (up to 250V)	
	Polarity when insert on terminal
	+ -
	- +
	(WSD 2.5) Without special components

Marking systems (see large assortment in chapter M)	
	Tags

For detailed information on additional accessories and usage instructions see chapter accessories.

WTR 4

4 mm²

With clamping screw

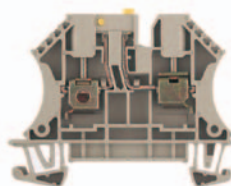

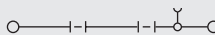
6.1 x 60 x 48.6	
32 / 6	
0.33 ... 6	

IEC 60947-7-1 / VDE 0100-537

IEC	UL	CSA	EN 50019
400	300	300	
32	10	10	
4	AWG 22 ...10	AWG 22...10	
		6 / 3	
		A4 / V-0	



Rated connection	
0.5...6 / 1.5...6	
0.5...4 / 0.5...4	
0.5...1.0 (M3)	
13 / 3.5 x 0.6	

2 clampable conductors of equal cross-section	
0.5...2.5	
0.5...1.5 / 0.5...1.5	

Type	Qty.	Order No.
WTR 4	50	7910180000
WTR 4 BL	50	7910190000

Information

Type	Current [A]	Qty.	Order No.
ZQV 4N/2	32	60	1758250000
ZQV 4N/3	32	60	1762630000
ZQV 4N/4	32	60	1762620000
ZQV 4N/10	32	20	1758260000

Width [mm]	
WAP 2.5-10	1.5 50 1050000000
WAP 2.5-10 BL	1.5 50 1050080000
WAP 16+35 WTW 2.5-10	1.5 20 1050100000

Width [mm]	
WEW-35/2	8 100 1061200000

SD 0.6X3.5X100	
	10 9008330000

SIHA 1/G20	
	25 9537550000
	25 9537560000
	25 9537590000

WS 12/6 / DEK 6

WTR 4 StB

4 mm²

With socket

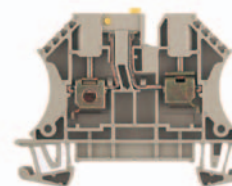

6.1 x 60 x 48.6	
32 / 6	
0.33 ... 6	

IEC 60947-7-1 / VDE 0100-537

IEC	UL	CSA	EN 50019
400	300	300	
32	10	10	
4	AWG 22 ...10	AWG 22...10	
		6 / 3	
		A4 / V-0	



Rated connection	
0.5...6 / 1.5...6	
0.5...4 / 0.5...4	
0.5...0.6 (M3)	
13 / 3.5 x 0.6	

2 clampable conductors of equal cross-section	
0.5...2.5	
0.5...1.5 / 0.5...1.5	

Type	Qty.	Order No.
WTR 4 STB	50	7910210000
WTR 4 STB BL	50	7910220000

Information

Type	Current [A]	Qty.	Order No.
ZQV 4N/2	32	60	1758250000
ZQV 4N/3	32	60	1762630000
ZQV 4N/4	32	60	1762620000
ZQV 4N/10	32	20	1758260000

Width [mm]	
WAP 2.5-10	1.5 50 1050000000
WAP 2.5-10 BL	1.5 50 1050080000
WAP 16+35 WTW 2.5-10	1.5 20 1050100000

Width [mm]	
WEW-35/2	8 100 1061200000

SD 0.6X3.5X100	
	10 9008330000

SIHA 1/G20	
	25 9537550000
	25 9537560000
	25 9537590000

WS 12/6 / DEK 6

Disconnect terminals

WDT 1.5/1

1.5 mm²

Disconnection lower level

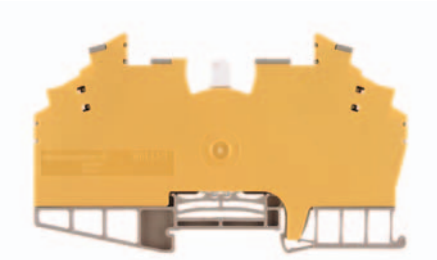

6.4 x 112 x 66.7
10 / 2.5
0.13 ... 2.5

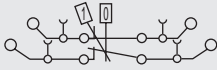

IEC 60947-7-1 / VDE 0100-537

IEC	UL	CSA	EN 50019
250	300	300	
10	10	10	
1.5	AWG 22 ...14	AWG 26...14	
		4 / 3	
		A2 / V-0	



Rated connection

0.5...2.5 / 1.5...2.5
0.5...1.5 / 0.5...1.5
0.4...0.6 (M 2.5)
10 / 3.5 x 0.6

WDT 1.5/2

1.5 mm²

Disconnection both levels

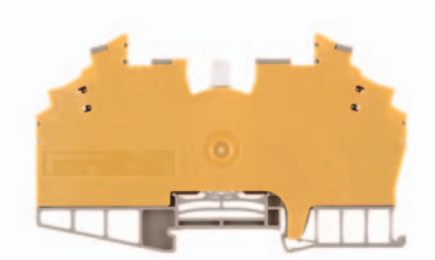

6.4 x 112 x 66.7
10 / 2.5
0.13 ... 2.5

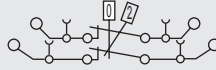

IEC 60947-7-1 / VDE 0100-537

IEC	UL	CSA	EN 50019
250	300	300	
10	10	10	
1.5	AWG 22 ...14	AWG 26...14	
		4 / 3	
		A2 / V-0	



Rated connection

0.5...2.5 / 1.5...2.5
0.5...1.5 / 0.5...1.5
0.4...0.6 (M 2.5)
10 / 3.5 x 0.6

WDT 1.5/3

1.5 mm²

Disconnection lower level or both levels

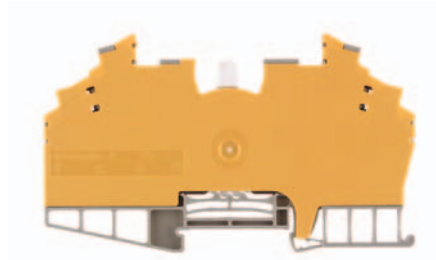

6.4 x 112 x 66.7
10 / 2.5
0.13 ... 2.5



IEC 60947-7-1 / VDE 0100-537

IEC	UL	CSA	EN 50019
250	300	300	
10	10	10	
1.5	AWG 22 ...14	AWG 26...14	
		4 / 3	
		A2 / V-0	



Rated connection

0.5...2.5 / 1.5...2.5
0.5...1.5 / 0.5...1.5
0.4...0.6 (M 2.5)
10 / 3.5 x 0.6

Type	Qty.	Order No.
WDT 1.5/1 DB/GE	25	1015800000

Type	Qty.	Order No.
WDT 1.5/2 DB/GE	25	1015900000

Type	Qty.	Order No.
WDT 1.5/3 DB/GE	25	1016000000
WDT 1.5/3 BL/HB	25	1016160000

Type	Current [A]	Qty.	Order No.

Width [mm]	Qty.	Order No.

Width [mm]	Qty.	Order No.
WEW-35/2	8 100	1061200000

Width [mm]	Qty.	Order No.
SD 0.6X3.5X100	10	9008330000

DEK 6,5 / WS 8/5

Type	Current [A]	Qty.	Order No.

Width [mm]	Qty.	Order No.

Width [mm]	Qty.	Order No.
WEW-35/2	8 100	1061200000

Width [mm]	Qty.	Order No.
SD 0.6X3.5X100	10	9008330000

DEK 6,5 / WS 8/5

Type	Current [A]	Qty.	Order No.

Width [mm]	Qty.	Order No.

Width [mm]	Qty.	Order No.
WEW-35/2	8 100	1061200000

Width [mm]	Qty.	Order No.
SD 0.6X3.5X100	10	9008330000

DEK 6,5 / WS 8/5

Articles with coloured order number are kept permanently in stock at the central warehouse in Germany. Delivery times see page X.2

Fuse terminals

Fuse terminals

When using ATEX certified components in hazardous area applications the installation instructions and the rated data for accessories in the technical appendix must be considered.

Width/Length/Height with TS35x7.5	mm
Max. current / max. cond. cross-section	A/mm ²
Max. clamping range	mm ²

Technical data

Rated data	
Rated voltage for adjacent terminal	V
Rated current	A
Rated cross-section	mm ²
Rated impulse voltage / Pollution severity	kV/-
Plug gauge IEC 60-947-1 / flammability class acc. UL94	
Approvals	

Clampable conductors (H05V/H07V)	
Solid / stranded	mm ²
Flexible / flexible w. wire end ferrule	mm ²
Tightening torque range (clamping screw)	Nm
Stripping length / blade size	mm / -

2 clampable conductors of equal cross-section	
Solid / stranded	mm ²
Flexible / flexible w. wire end ferrule	mm ²

Information	
Conductor 2.5 mm ² with wire end ferrule with plastic collar only with diameter optimised collar (Order No. 1333100000, Qty. 500)	

Ordering data

Version	
dark beige Wemid	400V ac/dc. without LED
	10-36V ac/dc. with LED
	30-70V ac/dc. with LED
	60-150V ac/dc. with LED
	140-250V ac/dc. with LED

Information	
UL/CSA specified for fuse cartridge 400V; otherwise the specified voltage range also applies to UL/CSA	

Accessories

Cross-connection, pluggable	
	2-pole
	3-pole
	4-pole
	10-pole

End plate / partition (behind last terminal)	
	End plate, dark beige Wemid
	Partition, dark beige Wemid

Screwdriver	
	w. cutting device "swifty set"
	Standard version

G-fuse cartridge 5 x 20mm (IEC 60127-2)	
Rated voltage 250V	0.25A quick
Rated switch-off capacity 1500A (at 250V / 50Hz / cos j = 0.7)	0.5A quick
	1A quick
	2A quick

G25 with indicator / Inch fuse	
G25 (DIN 41 576 / 250V)	0.5A medium-slow
Rated voltage 250V	1A medium-slow
Inch fuse 1/4 x 1 1/4	2A quick
Rated voltage 440V	4A quick

Marking systems (see large assortment in chapter M)	
	Tags

For detailed information on additional accessories and usage instructions see chapter accessories.

WTR 2.5/SI

2.5 mm²



5.1 x 60 x 80.5	
6.3 / 4	
0.13 ... 4	

IEC 60947-7-3 / VDE 0611-6			
IEC	UL	CSA	EN 50019
400	300	300	
6.3	6.3	6.3	
2.5	AWG 22 ...12	AWG 26...12	
		6 / 3	
		A3 / V-0	

Rated connection		Additional connection	
0.5...4	/ 1.5...4		
0.5...4	/ 0.5...2.5		
0.4...0.8	(M 2.5)		
10 / 3.5 x 0.6			

0.5...1.5	
0.5...1.5 / 0.5...1.5	

Conductor 2.5 mm² with wire end ferrule with plastic collar only with diameter optimised collar (Order No. 1333100000, Qty. 500)

Type	Qty.	Order No.
WTR 2.5/SI	25	1763940000
WTR 2.5/SI LD 36V	25	1763950000
WTR 2.5/SI LD 70V	25	1763960000
WTR 2.5/SI LD 150V	25	1763970000
WTR 2.5/SI LD 250V	25	1763980000

UL/CSA specified for fuse cartridge 400V; otherwise the specified voltage range also applies to UL/CSA

Type	Current [A]	Qty.	Order No.

Width [mm]			
WAP 2.5-10	1.5	50	1050000000
WAP 16+35 WTW 2.5-10	1.5	20	1050100000

SD 0.6X3.5X100	10	9008330000
----------------	----	------------

G 20/0.25A/F	10	0430500000
G 20/0.5A/F	10	0430600000
G 20/1A/F	10	0430700000
G 20/2A/F	10	0430900000

DEK 5 / WS 12/5		
-----------------	--	--

Possible cross-connections for WTR 2.5 see section Accessories W-series.

WTR 4/SI

4 mm²

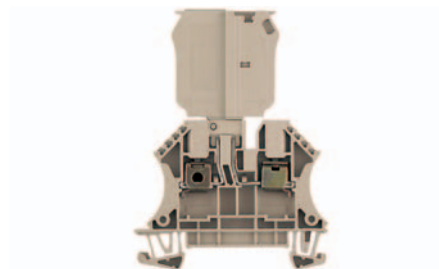

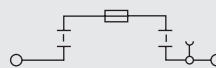
6.1 x 60 x 80.5	
6.3 / 6	
0.33 ... 6	

IEC 60947-7-3 / VDE 0611-6			
IEC	UL	CSA	EN 50019
400	300	300	
6.3	6.3	6.3	
4	AWG 22 ...10	AWG 22...10	
		6 / 3	
		A4 / V-0	

Rated connection		Additional connection	
0.5...6	/ 1.5...6		
0.5...4	/ 0.5...4		
0.5...1.0	(M 3)		
13 / 3.5 x 0.6			

0.5...2.5	
0.5...1.5 / 0.5...1.5	

The rated voltage of the terminal is determined by the max. power loss of 1.6W at the fuse cartridge.

Type	Qty.	Order No.
WTR 4 SI	25	7910240000
WTR 4/SI LD 36V	25	7914370000
WTR 4/SI LD 70V	25	7914380000
WTR 4/SI LD 150V	25	7914390000
WTR 4/SI LD 250V	25	7914400000

UL/CSA specified for fuse cartridge 400V; otherwise the specified voltage range also applies to for UL/CSA

Type	Current [A]	Qty.	Order No.
ZQV 4N/2	32 A	60	1758250000
ZQV 4N/3	32 A	60	1762630000
ZQV 4N/4	32 A	60	1762620000
ZQV 4N/10	32 A	20	1758260000

Width [mm]			
WAP 2.5-10	1.5	50	1050000000
WAP 16+35 WTW 2.5-10	1.5	20	1050100000

SD 0.6X3.5X100	10	9008330000
----------------	----	------------

G 20/0.25A/F	10	0430500000
G 20/0.5A/F	10	0430600000
G 20/1A/F	10	0430700000
G 20/2A/F	10	0430900000

WS 12/6 / DEK 6		
-----------------	--	--

Fuse terminals

KDKS 1/35 DB

4 mm²

Metric fuses 5x20mm

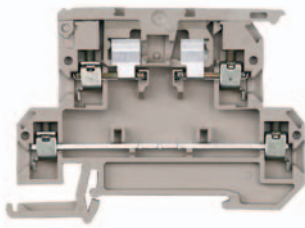

8 x 73.5 x 55.6

6.3 / 4

0.33 ... 4



IEC 60947-7-3 / VDE 0611-6

IEC	UL	CSA	EN 50019
500	300		
6.3	10		
4	AWG 22 ...12		
	6 / 3		
	A3 / V-0		

Rated connection

0.5...4 / 1.5...4

0.5...4 / 0.5...4

0.5...1.0 (M3)

8 / 3.5 x 0.6

0.5...1.5

0.5...1.5 / 0.5...1.5

2 conductors, solid, have to be connected at 0.6 Nm.

Type	Qty.	Order No.
KDKS 1/35 DB		9532440000

Max. power loss of 1.6 W at the fuse cartridge limits the rated current.

WSI 6

6 mm²

Metric fuses

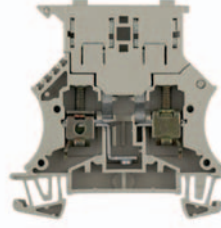

7.9 x 60 x 62

6.3 / 10

0.5 ... 10

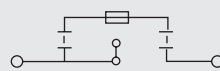

IEC 60947-7-3 / VDE 0611-6

IEC	UL	CSA	EN 50019
500	300	300	
6.3	6.3	6.3	
6	AWG 20 ...8	AWG 20...8	
	6 / 3		
	A5 / V-0		



Rated connection

0.5...10 / 1.5...10

0.5...10 / 0.5...6

0.8...1.6 (M3.5)

12 / 4.0 x 0.8

0.5...2.5

0.5...2.5 / 0.5...2.5

Fuse cartridges or contact sleeves have to be inserted in centre. Version with contact sleeve order no. 1028200000 (Qty. 50/10A)

Type	Qty.	Order No.
WSI 6	50	1011000000

Max. power loss at the fuse cartridge (1.6 W) limits the rated current of the terminal.

WSI 6 LD

6 mm²

Metric fuses / bipolar LED

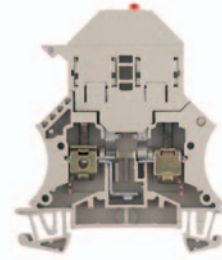

7.9 x 60 x 72

6.3 / 10

0.5 ... 10

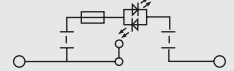

IEC 60947-7-3 / VDE 0611-6

IEC	UL	CSA	EN 50019
500	300	300	
6.3	6.3	6.3	
6	AWG 20 ...8	AWG 20...8	
	6 / 3		
	A5 / V-0		



Rated connection

0.5...10 / 1.5...10

0.5...10 / 0.5...6

0.8...1.6 (M3.5)

12 / 4.0 x 0.8

0.5...2.5

0.5...2.5 / 0.5...2.5

Fuse cartridges or contact sleeves have to be inserted in centre. With a defective fuse a residual current flows in the LED!

Type	Qty.	Order No.
WSI 6/LD 10-36V DC/AC	50	1011300000
WSI 6/LD 30-70V DC/AC	50	1012200000
WSI 6/LD 60-150V DC/AC	50	1012300000
WSI 6/LD 110DC 250AC	50	1012400000

Max. power loss at the fuse cartridge (1.6 W) limits the rated current.

Type	Current [A]	Qty.	Order No.

Width [mm]

AP KDKS1 1.5 DB	1.5	20	9532470000
-----------------	-----	----	------------

SD 0.6X3.5X100	10	9008330000
----------------	----	------------

G 20/0.25A/F	10	0430500000
--------------	----	------------

G 20/0.5A/F	10	0430600000
-------------	----	------------

G 20/1A/F	10	0430700000
-----------	----	------------

G 20/2A/F	10	0430900000
-----------	----	------------

WS 12/6,5 / DEK 8

Type	Current [A]	Qty.	Order No.

Width [mm]

WAP 2.5-10	1.5	50	1050000000
------------	-----	----	------------

WAP 16+35 WTW 2.5-10	1.5	20	1050100000
----------------------	-----	----	------------

SD 0.8X4.0X100	10	9008340000
----------------	----	------------

G 20/0.25A/F	10	0430500000
--------------	----	------------

G 20/0.5A/F	10	0430600000
-------------	----	------------

G 20/1A/F	10	0430700000
-----------	----	------------

G 20/2A/F	10	0430900000
-----------	----	------------

G 25/0.5A/M WS	10	0510300000
----------------	----	------------

G 25/1A/M RT	10	0265800000
--------------	----	------------

G 25/2A/F BL	10	0192700000
--------------	----	------------

G 25/4A/F BR	10	0192800000
--------------	----	------------

WS 12/6,5 / DEK 8

Cross-connection see section Accessories W-series spare isolating lever order no. 103660000 (Qty. 5)

Type	Current [A]	Qty.	Order No.

Width [mm]

WAP 2.5-10	1.5	50	1050000000
------------	-----	----	------------

WAP 16+35 WTW 2.5-10	1.5	20	1050100000
----------------------	-----	----	------------

SD 0.8X4.0X100	10	9008340000
----------------	----	------------

G 20/0.25A/F	10	0430500000
--------------	----	------------

G 20/0.5A/F	10	0430600000
-------------	----	------------

G 20/1A/F	10	0430700000
-----------	----	------------

G 20/2A/F	10	0430900000
-----------	----	------------

G 25/0.5A/M WS	10	0510300000
----------------	----	------------

G 25/1A/M RT	10	0265800000
--------------	----	------------

G 25/2A/F BL	10	0192700000
--------------	----	------------

G 25/4A/F BR	10	0192800000
--------------	----	------------

WS 12/6,5 / DEK 8

Cross-connection see section Accessories W-series spare isolating lever on request

Articles with coloured order number are kept permanently in stock at the central warehouse in Germany. Delivery times see page X.2

Fuse terminals

Fuse terminals

When using ATEX certified components in hazardous area applications the installation instructions and the rated data for accessories in the technical appendix must be considered.

Width/Length/Height with TS35x7.5	mm
Max. current / max. cond. cross-section	A/mm ²
Max. clamping range	mm ²

Technical data

Rated data	
Rated voltage for adjacent terminal	V
Rated current	A
Rated cross-section	mm ²
Rated impulse voltage / Pollution severity	kV/-
Plug gauge IEC 60-947-1 / flammability class acc. UL94	
Approvals	

Clampable conductors (H05V/H07V)

Solid / stranded	mm ²
Flexible / flexible w. wire end ferrule	mm ²
Tightening torque range (clamping screw)	Nm
Stripping length / blade size	mm / -

2 clampable conductors of equal cross-section

Solid / stranded	mm ²
Flexible / flexible w. wire end ferrule	mm ²

Information

Ordering data

Version		
dark beige Wemid	400V ac/dc. without LED	
	10-36V ac/dc. with LED	
	30-70V ac/dc. with LED	
	60-150V ac/dc. with LED	
	140-250V ac/dc. with LED	

Information

Accessories

Cross-connection, pluggable

	2-pole
	3-pole
	4-pole
	10-pole

End plate / partition (behind last terminal)

End plate, dark beige Wemid	
Partition, dark beige Wemid	

Screwdriver

	w. cutting device "swifty set"
	Standard version

G-fuse cartridge 5 x 20mm (IEC 60127-2)

Rated voltage 250V	0.25A quick
Rated switch-off capacity 1500A	0.5A quick
(at 250V / 50Hz / cos j = 0.7)	1A quick
	2A quick

G25 with indicator / Inch fuse

G25 (DIN 41 576 / 250V)	0.5A medium-slow
Rated voltage 250V	1A medium-slow
Inch fuse 1/4 x 1 1/4	2A quick
Rated voltage 440V	4A quick

Marking systems (see large assortment in chapter M)

Tags

For detailed information on additional accessories and usage instructions see chapter accessories.

WSI 6/2

6 mm²

Imperial fuses

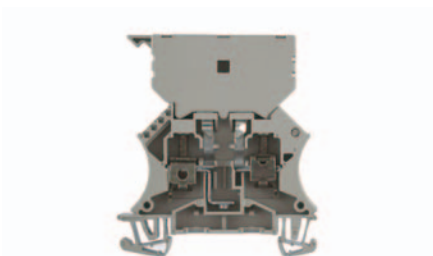

11.9 x 60 x 67
6.3 / 10
0.5 ... 10

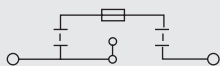

IEC 60947-7-3 / VDE 0611-6

IEC	UL	CSA	EN 50019
500	600	600	
6.3	6.3	6.3	
6	AWG 20 ...8	AWG 20...8	
6 / 3			
A5 / V-0			



Rated connection

0.5...10 / 1.5...10
0.5...10 / 0.5...6
0.8...1.6 (M 3.5)
12 / 4.0 x 0.8

Additional connection

0.5...2.5
0.5...2.5 / 0.5...2.5

Fuse cartridges or contact sleeves have to be inserted in the centre.

Type	Qty.	Order No.
WSI 6/2 GZ/DEF63	25	1014000000

Max. power loss at the fuse cartridge (1.6 W) limits the rated current.

Type	Current [A]	Qty.	Order No.

Width [mm]			
WAP 2.5-10	1.5	50	1050000000
WAP 16+35 WTW 2.5-10	1.5	20	1050100000

SD 0.8X4.0X100	10	9008340000
----------------	----	------------

GZ 2.0A	10	0294500000
GZ 3.0A	10	0295700000
GZ 5.0A	10	0294600000
GZ 10.0A	10	0293900000

DEK 8 / WS 12/6,5

Cross-connection see section Accessories W-series

WSI 6/2 m. LED

6 mm²

Imperial fuses / bipolar LED

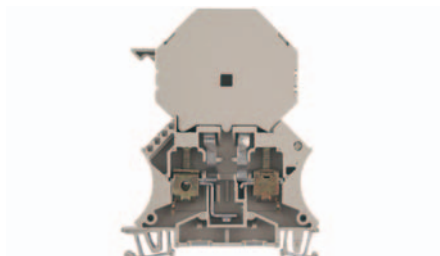

11.9 x 60 x 79.5
6.3 / 10
0.5 ... 10

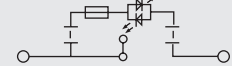

IEC 60947-7-3 / VDE 0611-6

IEC	UL	CSA	EN 50019
500	220	220	
6.3	6.3	6.3	
6	AWG 20 ...8	AWG 20...8	
6 / 3			
A5 / V-0			

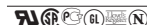

Rated connection

0.5...10 / 1.5...10
0.5...10 / 0.5...6
0.8...1.6 (M 3.5)
12 / 4.0 x 0.8

0.5...2.5
0.5...2.5 / 0.5...2.5

Fuse cartridges or contact sleeves have to be inserted in centre.

Type	Qty.	Order No.
WSI 6/2/LD 10-36V DC/AC	25	1014100000
WSI 6/2/LD 30-70V DC/AC	25	1014200000
WSI 6/2/LD 60-150VDC/AC	25	1014300000
WSI 6/2/LD 110DC 250AC	25	1014400000

Max. power loss at the fuse cartridge (1.6 W) limits the rated current.

Type	Current [A]	Qty.	Order No.

Width [mm]			
WAP 2.5-10	1.5	50	1050000000
WAP 16+35 WTW 2.5-10	1.5	20	1050100000

SD 0.8X4.0X100	10	9008340000
----------------	----	------------

GZ 2.0A	10	0294500000
GZ 3.0A	10	0295700000
GZ 5.0A	10	0294600000
GZ 10.0A	10	0293900000

WS 12/6,5 / DEK 8

Cross-connection see section Accessories W-series

Fuse terminals

SAKS 2/35 DB

10 mm²

D-fuses E16

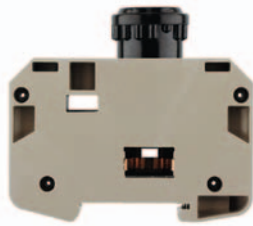

27.6 x 80 x 75

10 / 16

0.33 ... 16



IEC 60947-7-3 / VDE 0611-6

IEC	UL	CSA	EN 50019
500		600	
10		25	
10		AWG 22...8	
	6 / 3		
	B6 / V-0		

Rated connection

0.5...16 / 0.5...10

0.5...10 / 0.5...10

1.2...2.4 (M4)

12 / 5.5 x 1.0

Up to 10A in case of overloads, up to 25A for short-circuit-protection only

Type	Qty.	Order No.
SAKS 2/35 DB	20	1368700000

SAKS 4/35 DB

10 mm²

D 01-fuses E14



24 x 75 x 66

16 / 16

0.33 ... 16



IEC 60947-7-3 / VDE 0611-6

IEC	UL	CSA	EN 50019
400	600	600	
16	30	30	
10	AWG 22 ...8	AWG 22...8	
	6 / 3		
	B6 / V-0		

Rated connection

0.5...16 / 0.5...10

0.5...10 / 0.5...10

1.2...2.4 (M4)

14 / 5.5 x 1.0

400V also available with Neozed-shipbuilding-fuse

Type	Qty.	Order No.
SAKS 4/35 DB	20	501800000

Terminal made of Duroplast (KRG), coloured in the tone of the W-series

SAKS 5/35 DB

10 mm²

D 02-fuse E18

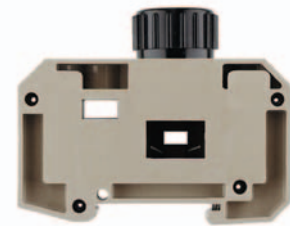

28 x 80 x 66

63 / 16

1.5 ... 16



IEC 60947-7-3 / VDE 0611-6

IEC	UL	CSA	EN 50019
400	600	600	
57	40	63	
10	AWG 14 ...6	AWG 14...6	
	6 / 3		
	B7 / V-0		

Rated connection

1.5...16 / 1.5...16

1.5...16 / 1.5...16

1.2...2.4 (M4)

13 / 5.5 x 1.0

400V also available with Neozed-shipbuilding-fuse
16mm² stranded has to be conducted with 2 Nm

Type	Qty.	Order No.
SAKS 5/35 DB	20	502100000

Material made of Duroplast (KRG), coloured in the tone of the W-series

Type	Current [A]	Qty.	Order No.
WTW EN	1.5	20	1058800000

Width [mm]			
WTW EN	1.5	20	1058800000

Type	Current [A]	Qty.	Order No.
SD 1.0X5.5X150		10	9008350000

D fuse inserts

E 10 A	25	0208500000
E 16 A	25	0208600000
E 20 A	25	0208700000
E 25 A	25	0208800000

gauge rings

P 16/10	100	0208900000
P 16/16	100	0209000000
P 16/20	100	0209100000

DEK 5 / WS 12/6,5

Spare screw-cap order no. 0284110000 (Qty. 20); cross-connection see section Accessories W-series

Type	Current [A]	Qty.	Order No.
WTW EN	1.5	20	1058800000

Width [mm]			
WTW EN	1.5	20	1058800000

Type	Current [A]	Qty.	Order No.
SD 1.0X5.5X150		10	9008350000

D1 fuse inserts

E 14/2	10	0137400000
E 14/4	10	0137500000
E 14/6	10	0328300000
E 14/10	10	0328400000
E 14/16	10	0328500000

gauge rings

P 14/2	50	0138000000
P 14/4	50	0138100000
P 14/6	50	0328600000
P 14/10	50	0328700000

WS 12/6,5 / DEK 5

Spare screw-cap order no. 0339410000 (Qty. 20); cross-connection see section Accessories W-series

Type	Current [A]	Qty.	Order No.
WTW EN	1.5	20	1058800000

Width [mm]			
WTW EN	1.5	20	1058800000

Type	Current [A]	Qty.	Order No.
SD 1.0X5.5X150		10	9008350000

D2 fuse inserts

E 18/20	10	0361300000
E 18/25	10	0361400000
E 18/35	10	0361500000
E 18/50	10	0361600000
E 18/63	10	0361700000

gauge rings

P 18/20	50	0361800000
P 18/25	50	0361900000
P 18/35	50	0362000000
P 18/50	50	0362100000

DEK 5 / WS 12/6,5

Spare screw-cap order no. 0359310000 (Qty. 20); cross-connection see section Accessories W-series

Articles with coloured order number are kept permanently in stock at the central warehouse in Germany.
Delivery times see page X.2

Installation terminals

Distribution terminal with WQV

In certain applications (medical systems) N-bus-bars are not needed. This is where these installation terminals with disconnectors in the centre of the terminal can be used.

When using ATEX certified components in hazardous area applications the installation instructions and the rated data for accessories in the technical appendix must be considered.

Width/Length/Height with TS35x5.5	mm
Max. current / max. cond. cross-section	A/mm ²
Max. clamping range	mm ²

Technical data

Rated data	
Rated voltage	V
Rated current	A
Rated cross-section	mm ²
Rated impulse voltage / Pollution severity	kV/-
Plug gauge IEC 60-947-1 / flammability class acc. UL94	
Approvals	

Clampable conductors (H05V/H07V)	
Solid / stranded	mm ²
Flexible / flexible w. wire end ferrule	mm ²
Tightening torque range (clamping screw)	Nm
Stripping length / blade size	mm / -

2 clampable conductors of equal cross-section	
Solid / stranded	mm ²
Flexible / flexible w. wire end ferrule	mm ²

Information

Ordering data

Version	
dark beige Wemid	
blue Wemid	

Information

Accessories

Cross-connection output-side (screwable)	
 (Q3)	
2-pole	
3-pole	
4-pole	
10-pole	
20-pole	

Cross-connection access-side (screwable)	
 (WQV 2.5-3)	
2-pole	
3-pole	
4-pole	
10-pole	

End plate / partition	
End plate	dark beige Wemid blue Wemid
Partition	dark beige Wemid blue Wemid

End bracket	
	dark beige

Testing	
For testing of wired terminal strips	Standard version With spigot

Cover	
 (WAD 5)	With elec. shock warn. symbol neutral

Marking systems	(see large assortment in chapter M)
	Tags

For detailed information on additional accessories and usage instructions see chapter accessories.

WDL 2.5/NT/L/PE

2.5 mm²

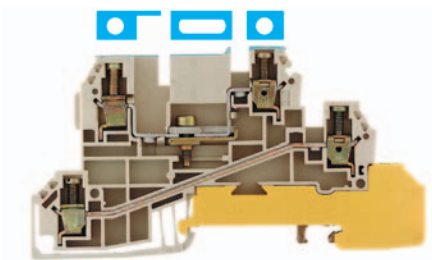

6.1 x 90 x 49	
32 / 6	
0.13 ... 6	

IEC 60947-7-1 (-7-2) / VDE 0611-4

IEC	UL	CSA	EN 50019
400	300	300	
24	15	10	
2.5	AWG 22 ...12	AWG 26...12	
4 / 3			
A3 / A4 / V-0			

Rated connection	Additional connection
0.5...4 / 1.5...4	0.5...6 / 1.5...4
0.5...4 / 0.5...2.5	0.5...4 / 0.5...4
0.4...0.6 (M 2.5)	0.5...0.6 (M 3)
8 / 3.5 x 0.6	8 / 3.5 x 0.6

2 clampable conductors of equal cross-section	
Solid / stranded	mm ²
Flexible / flexible w. wire end ferrule	mm ²

Information
L-PE / L-NT 250V / Further connection: 2 solid conductors 1.5mm ² have to be connected at 0.6 Nm.

Type	Qty.	Order No.
WDL 2.5/NT/L/PE	50	1029800000

Information
Further connection refers to clamping point top left (A4)

WDL 2.5/L/L

2.5 mm²

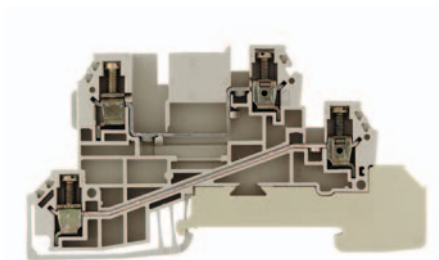

6.1 x 90 x 49	
32 / 6	
0.13 ... 6	

IEC 60947-7-1 / VDE 0611-4

IEC	UL	CSA	EN 50019
400	300	300	
24	15	10	
2.5	AWG 22 ...12	AWG 26...12	
6 / 3			
A3 / A4 / V-0			

Rated connection	Additional connection
0.5...4 / 1.5...4	0.5...6 / 1.5...4
0.5...4 / 0.5...2.5	0.5...4 / 0.5...4
0.4...0.6 (M 2.5)	0.5...0.6 (M 3)
8 / 3.5 x 0.6	8 / 3.5 x 0.6

2 clampable conductors of equal cross-section	
Solid / stranded	mm ²
Flexible / flexible w. wire end ferrule	mm ²

Information
Further connection refers to clamping point top left (A4) 2 conductors 1.5mm ² , solid, with 0.6 Nm

Type	Qty.	Order No.
WDL 2.5/L/L	50	1030300000

Information
WDL 2.5/N/L Order No. 1030000000 (upper connection marked blue)

Installation terminals

WDL 2.5/N/L/PE

2.5 mm²

WDL 2.5/L/L/PE

2.5 mm²

WDL 2.5/L

2.5 mm²

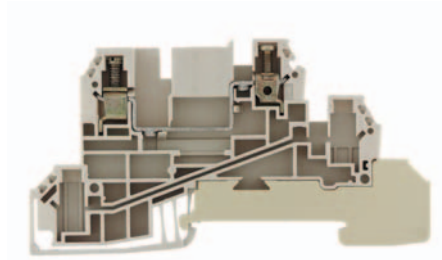
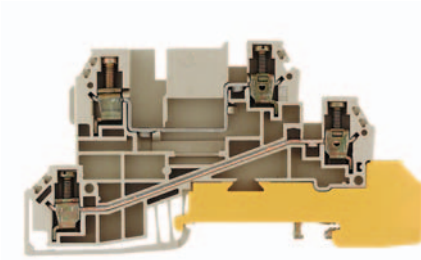
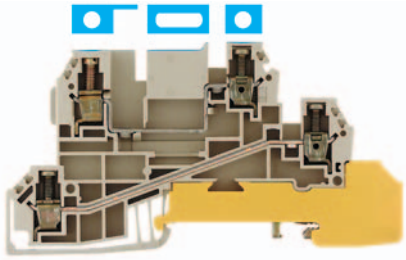

6.1 x 90 x 49
32 / 6
0.13 ... 6

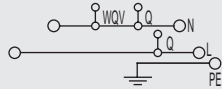

6.1 x 90 x 49
32 / 6
0.13 ... 6

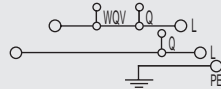

6.1 x 90 x 49
32 / 6
0.13 ... 6

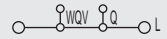

IEC 60947-7-1 (-7-2) / VDE 0611-4

IEC	UL	CSA	EN 50019
400	300	300	
24	15	10	
2.5	AWG 22 ...12	AWG 26...12	
4 / 3			
A3 / A4 / V-0			

IEC 60947-7-1 (-7-2) / VDE 0611-4

IEC	UL	CSA	EN 50019
400	300	300	
24	15	10	
2.5	AWG 22 ...12	AWG 26...12	
4 / 3			
A3 / A4 / V-0			

IEC 60947-7-1 / VDE 0611-4

IEC	UL	CSA	EN 50019
400	300	300	
24	15	10	
2.5	AWG 22 ...12	AWG 26...12	
6 / 3			
A3 / A4 / V-0			



Rated connection	Additional connection
0.5...4 / 1.5...4	0.5...6 / 1.5...4
0.5...4 / 0.5...2.5	0.5...4 / 0.5...4
0.4...0.6 (M 2.5)	0.5...0.6 (M 3)
8 / 3.5 x 0.6	8 / 3.5 x 0.6

0.5...1.5	0.5...1.5
0.5...1.5 / 0.5...1.5	0.5...1.5 / 0.5...1.5

L-PE / L-N 250V / Further connection: 2 conductors 1.5mm² solid have to be connected at 0.6 Nm.



Rated connection	Additional connection
0.5...4 / 1.5...4	0.5...6 / 1.5...4
0.5...4 / 0.5...2.5	0.5...4 / 0.5...4
0.4...0.6 (M 2.5)	0.5...0.6 (M 3)
8 / 3.5 x 0.6	8 / 3.5 x 0.6

0.5...1.5	0.5...1.5
0.5...1.5 / 0.5...1.5	0.5...1.5 / 0.5...1.5

Further connection refers to clamping point top left (A4)
2 conductors 1.5mm², solid, with 0.6 Nm



Rated connection	Additional connection
0.5...4 / 1.5...4	0.5...6 / 1.5...4
0.5...4 / 0.5...2.5	0.5...4 / 0.5...4
0.4...0.6 (M 2.5)	0.5...0.6 (M 3)
8 / 3.5 x 0.6	8 / 0.6 x 3.5

0.5...1.5	0.5...1.5
0.5...1.5 / 0.5...1.5	0.5...1.5 / 0.5...1.5

Further connection refers to clamping point top left (A4)
2 conductors 1.5mm², solid, with 0.6 Nm

Type	Qty.	Order No.
WDL 2.5/N/L/PE	50	1029900000

Further connection refers to clamping point top left (A4)

Type	Qty.	Order No.
WDL 2.5/L/L/PE	50	1030200000

PE connection marked green/yellow

Type	Qty.	Order No.
WDL 2.5/L	50	1030400000

WDL 2.5/N Order No. 1030100000 (connection blue marks)

Type	Current [A]	Qty.	Order No.
Q 2 WDL2.5S	24	50	1071500000
Q 3 WDL2.5S	24	50	1071600000
Q 4 WDL2.5S	24	50	1071700000
Q 10 WDL2.5S	24	20	1071800000
Q 20 WDL2.5S	24	20	1074200000

Current [A]			
WQV 4/2	41	50	1051960000
WQV 4/3	41	50	1054560000
WQV 4/4	41	50	1054660000
WQV 4/10	41	20	1052060000

Width [mm]			
WAP WDL2.5	1.5	20	1067800000

Width [mm]			
WEW-35/2	8	100	1061200000

WS 8/5 / DEK 6

Type	Current [A]	Qty.	Order No.
Q 2 WDL2.5S	24	50	1071500000
Q 3 WDL2.5S	24	50	1071600000
Q 4 WDL2.5S	24	50	1071700000
Q 10 WDL2.5S	24	20	1071800000
Q 20 WDL2.5S	24	20	1074200000

Current [A]			
WQV 4/2	41	50	1051960000
WQV 4/3	41	50	1054560000
WQV 4/4	41	50	1054660000
WQV 4/10	41	20	1052060000

Width [mm]			
WAP WDL2.5	1.5	20	1067800000

Width [mm]			
WEW-35/2	8	100	1061200000

WS 8/5 / DEK 6

Type	Current [A]	Qty.	Order No.
Q 2 WDL2.5S	24	50	1071500000
Q 3 WDL2.5S	24	50	1071600000
Q 4 WDL2.5S	24	50	1071700000
Q 10 WDL2.5S	24	20	1071800000
Q 20 WDL2.5S	24	20	1074200000

Current [A]			
WQV 4/2	41	50	1051960000
WQV 4/3	41	50	1054560000
WQV 4/4	41	50	1054660000
WQV 4/10	41	20	1052060000

Width [mm]			
WAP WDL2.5	1.5	20	1067800000

Width [mm]			
WEW-35/2	8	100	1061200000

WS 8/5 / DEK 6

Installation terminals

Distribution terminals with 10x3 bus-bar

Space saving distribution terminals for three phase circuits.

When using ATEX certified components in hazardous area applications the installation instructions and the rated data for accessories in the technical appendix must be considered.

Width/Length/Height with TS35x7.5	mm
Max. current / max. cond. cross-section	A/mm ²
Max. clamping range	mm ²

Technical data

Rated data	
Rated voltage	V
Rated current	A
Rated cross-section	mm ²
Rated impulse voltage / Pollution severity	kV/-
Plug gauge IEC 60-947-1 / flammability class acc. UL94	
Approvals	

Clampable conductors (H05V/H07V)	
Solid / stranded	mm ²
Flexible / flexible w. wire end ferrule	mm ²
Stripping length / blade size	mm / -
Tightening torque range (clamping screw)	Nm

Information

Ordering data

Version
dark beige Wemid
blue Wemid

Information

Accessories

Cross-connection	
(ZQV 2.5N/4 - pluggable) (Q3 - screwable)	
2-pole	
3-pole	
4-pole	
10-pole	
30-/41-/50-pole	



End plate / partition	
dark beige Wemid	
blue Wemid	

Holding plate for 10 x 3	
blue Wemid	
for vertical mounting position	



End bracket	
dark beige	

Screwdriver	
w. cutting device "swifty set"	
Standard version	

Busbar 10 x 3	
Lower edge busbar to upper edge TS35 = 25.5mm	

Tension clamp for feeding 10 x 3 busbars	
Rigid / flexible 0.5 - 6 / 4mm ²	
Rigid / flexible 6 - 16mm ²	
flexible 16 - 35mm ²	



Marking systems (see large assortment in chapter M)	
Tags	

For detailed information on additional accessories and usage instructions see chapter accessories.

WDL 2.5/S/NT/L/PE

2.5 mm²

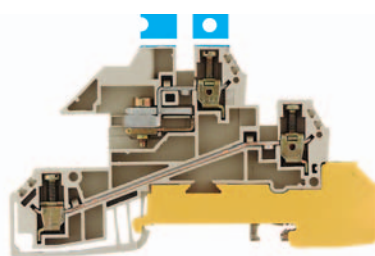

6.1 x 84.5 x 49	
32 / 4	
0.13 ... 4	

IEC 60947-7-1 (-7-2) / VDE 0611-4

IEC	UL	CSA	EN 50019
400	300	300	
24	15	10	
2.5	AWG 22 ...12	AWG 26...12	
		4 / 3	
		A3 / V-0	



Rated connection	
0.5...4 / 1.5...4	
0.5...4 / 0.5...2.5	
8 / 3.5 x 0.6	
0.4...0.6 (M 2.5)	

Rated voltage L-PE and L-NT 250V	
Tightening torque disconnect 0.4...0.6 Nm	

Type	Qty.	Order No.
WDL 2.5/S/NT/L/PE	50	1030600000

Three-phase circuit in combination with WDL 2.5/S/L/L

Type	Current [A]	Qty.	Order No.
Q 2 WDL2.5S	24	50	1071500000
Q 3 WDL2.5S	24	50	1071600000
Q 4 WDL2.5S	24	50	1071700000
Q 10 WDL2.5S	24	20	1071800000

Width [mm]	
WAP WDL2.5/S	1.5 20 1067700000

Width [mm]	
WHP 2.5-35N/10x3	2 20 1050200000

Width [mm]	
WEW-35/2	8 100 1061200000

SD 0.6X3.5X100	10	9008330000
----------------	----	------------

SSCH 10X3X1000 CU/SN	1	0348900000
----------------------	---	------------

Width [mm]	
ZB 4	5.6 50 0316500000
ZB 16 ZKSC	10 50 0316600000
ZB 35/M6X16	14 20 0266500000

WS 8/5 / DEK 6	
----------------	--

WDL 2.5/S/L/L

2.5 mm²

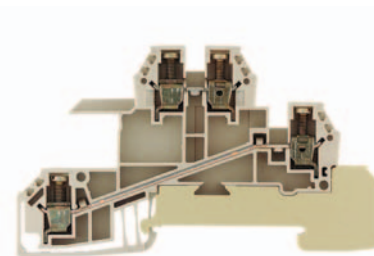

6.1 x 84.5 x 49	
32 / 4	
0.13 ... 4	

IEC 60947-7-1 / VDE 0611-4

IEC	UL	CSA	EN 50019
400	300	300	
24	15	10	
2.5	AWG 22 ...12	AWG 26...12	
		6 / 3	
		A3 / V-0	



Rated connection	
0.5...4 / 1.5...4	
0.5...4 / 0.5...2.5	
8 / 3.5 x 0.6	
0.4...0.6 Nm (M 2.5)	

Type	Qty.	Order No.
WDL 2.5/S/L/L	50	1031200000

Order No. 1031300000 (connection blue marks)

Type	Current [A]	Qty.	Order No.
Q 2 WDL2.5S	24	50	1071500000
Q 3 WDL2.5S	24	50	1071600000
Q 4 WDL2.5S	24	50	1071700000
Q 10 WDL2.5S	24	20	1071800000

Width [mm]	
WAP WDL2.5/S	1.5 20 1067700000

Width [mm]	
WHP 2.5-35N/10x3	2 20 1050200000

Width [mm]	
WEW-35/2	8 100 1061200000

SD 0.6X3.5X100	10	9008330000
----------------	----	------------

SSCH 10X3X1000 CU/SN	1	0348900000
----------------------	---	------------

Width [mm]	
ZB 4	5.6 50 0316500000
ZB 16 ZKSC	10 50 0316600000
ZB 35/M6X16	14 20 0266500000

WS 8/5 / DEK 6	
----------------	--

Installation terminals

WDL 2.5/S/N/L/PE

2.5 mm²

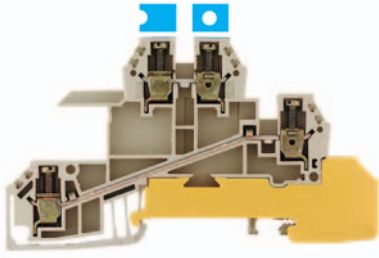

6.1 x 84.5 x 49
32 / 4
0.13 ... 4

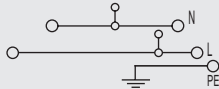

IEC 60947-7-1 (-7-2) / VDE 0611-4

IEC	UL	CSA	EN 50019
400	300	300	
24	15	10	
2.5	AWG 22 ...12	AWG 26...12	
4 / 3			
A3 / V-0			



Rated connection

0.5...4 / 1.5...4
0.5...4 / 0.5...2.5
8 / 3.5 x 0.6
0.4...0.6 Nm (M 2.5)

L-PE / L-N 250V

WDL 2.5/S/L/L/PE

2.5 mm²

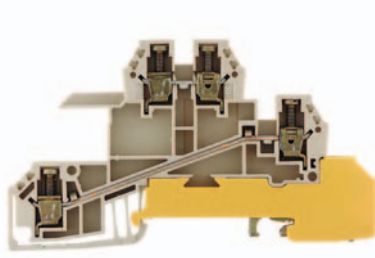

6.1 x 84.5 x 49
32 / 4
0.13 ... 4

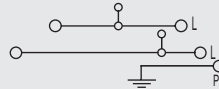

IEC 60947-7-1 (-7-2) / VDE 0611-4

IEC	UL	CSA	EN 50019
400	300	300	
24	15	10	
2.5	AWG 22 ...12	AWG 26...12	
4 / 3			
A3 / V-0			



Rated connection

0.5...4 / 1.5...4
0.5...4 / 0.5...2.5
8 / 3.5 x 0.6
0.4...0.6 Nm (M 2.5)

L-PE 250V

WDL 2.5/S/L

2.5 mm²



6.1 x 84.5 x 49
32 / 4
0.13 ... 4

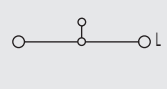

IEC 60947-7-1 / VDE 0611-4

IEC	UL	CSA	EN 50019
400	300	300	
24	15	10	
2.5	AWG 22 ...12	AWG 26...12	
6 / 3			
A3 / V-0			



Rated connection

0.5...4 / 1.5...4
0.5...4 / 0.5...2.5
8 / 3.5 x 0.6
0.4...0.6 Nm (M 2.5)

Type	Qty.	Order No.
WDL 2.5/S/N/L/PE	50	1030700000

Type	Qty.	Order No.
WDL 2.5/S/L/L/PE	50	1031100000

Type	Qty.	Order No.
WDL 2.5/S/L	50	1031300000

Order No. 1031300000 (connection blue marks)

Type	Current [A]	Qty.	Order No.
Q 2 WDL2.5S	24	50	1071500000
Q 3 WDL2.5S	24	50	1071600000
Q 4 WDL2.5S	24	50	1071700000
Q 10 WDL2.5S	24	20	1071800000

Type	Current [A]	Qty.	Order No.
Q 2 WDL2.5S	24	50	1071500000
Q 3 WDL2.5S	24	50	1071600000
Q 4 WDL2.5S	24	50	1071700000
Q 10 WDL2.5S	24	20	1071800000

Type	Current [A]	Qty.	Order No.
Q 2 WDL2.5S	24	50	1071500000
Q 3 WDL2.5S	24	50	1071600000
Q 4 WDL2.5S	24	50	1071700000
Q 10 WDL2.5S	24	20	1071800000

Width [mm]			
WAP WDL2.5/S	1.5	20	1067700000

Width [mm]			
WAP WDL2.5/S	1.5	20	1067700000

Width [mm]			
WAP WDL2.5/S	1.5	20	1067700000

Width [mm]			
WHP 2.5-35N/10x3	2	20	1050200000

Width [mm]			
WHP 2.5-35N/10x3	2	20	1050200000

Width [mm]			
WHP 2.5-35N/10x3	2	20	1050200000

Width [mm]			
WEW-35/2	8	100	1061200000

Width [mm]			
WEW-35/2	8	100	1061200000

Width [mm]			
WEW-35/2	8	100	1061200000

SD 0.6X3.5X100	10	9008330000
----------------	----	------------

SD 0.6X3.5X100	10	9008330000
----------------	----	------------

SD 0.6X3.5X100	10	9008330000
----------------	----	------------

SSCH 10X3X1000 CU/SN	1	0348900000
----------------------	---	------------

SSCH 10X3X1000 CU/SN	1	0348900000
----------------------	---	------------

SSCH 10X3X1000 CU/SN	1	0348900000
----------------------	---	------------

Width [mm]			
ZB 4	5.6	50	0316500000
ZB 16 ZKSC	10	50	0316600000
ZB 35/M6X16	14	20	0266500000

Width [mm]			
ZB 4	5.6	50	0316500000
ZB 16 ZKSC	10	50	0316600000
ZB 35/M6X16	14	20	0266500000

Width [mm]			
ZB 4	5.6	50	0316500000
ZB 16 ZKSC	10	50	0316600000
ZB 35/M6X16	14	20	0266500000

WS 8/5 / DEK 6

WS 8/5 / DEK 6

WS 8/5 / DEK 6

Articles with coloured order number are kept permanently in stock at the central warehouse in Germany. Delivery times see page X.2

Installation terminals

Neutral disconnect terminals

These special terminals for insulation measurements without dismantling of the conductor according to VDE-Norms are prescribed for places of public meetings.

When using ATEX certified components in hazardous area applications the installation instructions and the rated data for accessories in the technical appendix must be considered.

Width/Length/Height with TS35x7.5	mm
Max. current / max. cond. cross-section	A/mm ²
Max. clamping range	mm ²

Technical data

Rated data	
Rated voltage	V
Rated current	A
Rated cross-section	mm ²
Rated impulse voltage / Pollution severity	kV/-
Plug gauge IEC 60-947-1 / flammability class acc. UL94	
Approvals	

Clampable conductors (H05V/H07V)

Solid / stranded	mm ²
Flexible / flexible w. wire end ferrule	mm ²
Stripping length / blade size	mm / -
Tightening torque range (clamping screw)	Nm

Information

Ordering data

Version	dark beige Wemid blue Wemid
Information	

Accessories

Cross-connection	
(ZQV 2.5N/4 - pluggable) (Q3 - screwable)	2-pole 3-pole 4-pole 10-pole 30-/41-/50-pole

End plate / partition	
	dark beige Wemid blue Wemid

Holding plate for 10 x 3	
	blue Wemid for vertical mounting position

End bracket	
	dark beige

Screwdriver	
	w. cutting device "swifty set" Standard version

Busbar 10 x 3	
	Lower edge busbar to upper edge TS35 = 25.5mm

Tension clamp for feeding 10 x 3 busbars	
	Rigid / flexible 0.5 - 6 / 4mm ² Rigid / flexible 6 - 16mm ² flexible 16 - 35mm ²

Marking systems (see large assortment in chapter M)	
	Tags

For detailed information on additional accessories and usage instructions see chapter accessories.

WNT 2.5

2.5 mm²

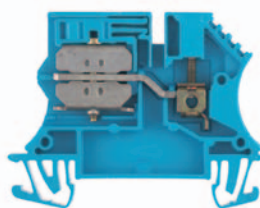

5.1 x 60 x 47	
32 / 4	NT
0.13 ... 4	

IEC 60947-7-1 / VDE 0611-4

IEC	UL	CSA	EN 50019
400	600	600	
24	25	20	
2.5	AWG 22 ...12	AWG 26...12	
		6 / 3	
		A3 / V-0	

Approvals: UL, CE, etc.

Rated connection

0.5...4 / 1.5...4
0.5...4 / 0.5...2.5
10 / 3.5 x 0.6
0.4...0.6 (M 2.5)

Conductor 2.5 mm² with wire end ferrule with plastic collar only with diameter optimised collar (Order No. 1333100000, Qty. 500)

Type	Qty.	Order No.
WNT 2.5 10X3 BE	100	1010600000
WNT 2.5 10X3	100	1010680000
Tightening torque N-disconnector 0.4..0.6 Nm		

Type	Current [A]	Qty.	Order No.

Width [mm]			
WAP 2.5-10	1.5	50	1050000000
WAP 2.5-10 BL	1.5	50	1050080000

Width [mm]			
WHP 2.5-35N/10x3 BL	2	20	1050280000

Width [mm]			
WEW-35/2	8	100	1061200000

SD 0.6X3.5X100	10	9008330000
----------------	----	------------

SSCH 10X3X1000 CU/SN	1	0348900000
----------------------	---	------------

Width [mm]			
ZB 4	5.6	50	0316500000
ZB 16 ZKSC	10	50	0316600000
ZB 35/M6X16	14	20	0266500000

Marking systems	
	DEK 5 / WS 12/5

WNT 4

4 mm²

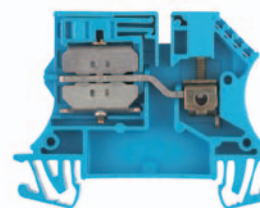

6.1 x 60 x 47	
41 / 6	NT
0.13 ... 6	

IEC 60947-7-1 / VDE 0611-4

IEC	UL	CSA	EN 50019
400	600	600	
32	35	35	
4	AWG 22 ...10	AWG 26...10	
		6 / 3	
		A4 / V-0	

Approvals: UL, CE, etc.

Rated connection

0.5...6 / 1.5...6
0.5...6 / 0.5...4
10 / 3.5 x 0.6
0.5...1.0 Nm (M 3)

Tightening torque N-disconnector 0.4..0.8 Nm

Type	Qty.	Order No.
WNT 4 10X3 BE	100	1010700000
WNT 4 10X3	100	1010780000

Type	Current [A]	Qty.	Order No.

Width [mm]			
WAP 2.5-10	1.5	50	1050000000
WAP 2.5-10 BL	1.5	50	1050080000

Width [mm]			
WHP 2.5-35N/10x3 BL	2	20	1050280000

Width [mm]			
WEW-35/2	8	100	1061200000

SD 0.6X3.5X100	10	9008330000
----------------	----	------------

SSCH 10X3X1000 CU/SN	1	0348900000
----------------------	---	------------

Width [mm]			
ZB 4	5.6	50	0316500000
ZB 16 ZKSC	10	50	0316600000
ZB 35/M6X16	14	20	0266500000

Marking systems	
	DEK 6 / WS 12/6

Installation terminals

WNT 6

6 mm²

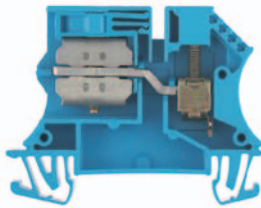

7.9 x 60 x 47
57 / 10
0.5 ... 10



IEC 60947-7-1 / VDE 0611-4

IEC	UL	CSA	EN 50019
400	600	600	
41	45	45	
6	AWG 20 ...8	AWG 20...8	
	6 / 3		
	A5 / V-0		



Rated connection

0.5...10 / 1.5...10

0.5...10 / 0.5...6

12 / 4.0 x 0.8

0.8...1.2 Nm (M 3.5)

Tightening torque N-disconnector 0,8...1,6 Nm

WNT 10

10 mm²

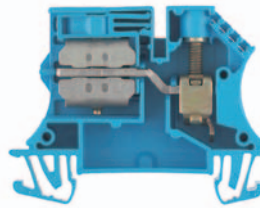

9.9 x 60 x 47
76 / 16
1.31 ... 16



IEC 60947-7-1 / VDE 0611-4

IEC	UL	CSA	EN 50019
400	600	600	
57	60	65	
10	AWG 16 ...6	AWG 16...6	
	6 / 3		
	B6 / V-0		



Rated connection

1.5...16 / 1.5...16

1.5...16 / 1.5...16

12 / 5.5 x 1.0

1.2...2.0 Nm (M 4)

Tightening torque N-disconnector 0,8...1,6 Nm

Type	Qty.	Order No.
WNT 6 10X3 BE	50	1010800000
WNT 6 10X3	50	1010880000

Type	Qty.	Order No.
WNT 10 10X3 BE	50	1010900000
WNT 10 10X3	50	1010980000

Type	Current [A]	Qty.	Order No.

Width [mm]			
WAP 2.5-10	1.5	50	1050000000
WAP 2.5-10 BL	1.5	50	1050080000

Width [mm]			
WHP 2.5-35N/10x3 BL	2	20	1050280000

Width [mm]			
WEW-35/2	8	100	1061200000

SD 0.8X4.0X100	10	9008340000
----------------	----	------------

SSCH 10X3X1000 CU/SN	1	0348900000
----------------------	---	------------

Width [mm]			
ZB 4	5.6	50	0316500000
ZB 16 ZKSC	10	50	0316600000
ZB 35/M6X16	14	20	0266500000

DEK 8 / WS 12/6,5

Type	Current [A]	Qty.	Order No.

Width [mm]			
WAP 2.5-10	1.5	50	1050000000
WAP 2.5-10 BL	1.5	50	1050080000

Width [mm]			
WHP 2.5-35N/10x3 BL	2	20	1050280000

Width [mm]			
WEW-35/2	8	100	1061200000

SD 1.0X5.5X150	10	9008350000
----------------	----	------------

SSCH 10X3X1000 CU/SN	1	0348900000
----------------------	---	------------

Width [mm]			
ZB 4	5.6	50	0316500000
ZB 16 ZKSC	10	50	0316600000
ZB 35/M6X16	14	20	0266500000

WS 12/6,5 / DEK 8

For PEN-bridges see section Accessories W-series

Articles with coloured order number are kept permanently in stock at the central warehouse in Germany.
Delivery times see page X.2

Installation terminals

Neutral disconnect terminals

These special terminals for insulation measurements without dismantling of the conductor according to VDE-Norms are prescribed for places of public meetings.

When using ATEX certified components in hazardous area applications the installation instructions and the rated data for accessories in the technical appendix must be considered.

Width/Length/Height with TS35x7.5	mm
Max. current / max. cond. cross-section	A/mm ²
Max. clamping range	mm ²

Technical data

Rated data	
Rated voltage	V
Rated current	A
Rated cross-section	mm ²
Rated impulse voltage / Pollution severity	kV/-
Plug gauge IEC 60-947-1 / flammability class acc. UL94	
Approvals	

Clampable conductors (H05V/H07V)

Solid / stranded	mm ²
Flexible / flexible w. wire end ferrule	mm ²
Stripping length / blade size	mm / -
Tightening torque range (clamping screw)	Nm

Information

Ordering data

Version	Information
dark beige Wemid	
blue Wemid	

Accessories

Cross-connection	
(ZQV 2.5N/4 - pluggable) (Q3 - screwable)	2-pole
	3-pole
	4-pole
	10-pole
	30-/41-/50-pole

End plate / partition	
dark beige Wemid	
blue Wemid	

Holding plate for 10 x 3	
blue Wemid	
for vertical mounting position	

End bracket	
dark beige	

Screwdriver	
w. cutting device "swifty set"	
Standard version	

Busbar 10 x 3	
Lower edge busbar to upper edge TS35 = 25.5mm	

Tension clamp for feeding 10 x 3 busbars	
Rigid / flexible 0.5 - 6 / 4mm ²	
Rigid / flexible 6 - 16mm ²	
flexible 16 - 35mm ²	

Marking systems (see large assortment in chapter M)	
Tags	

For detailed information on additional accessories and usage instructions see chapter accessories.	
--	--

WNT 16N

16 mm²

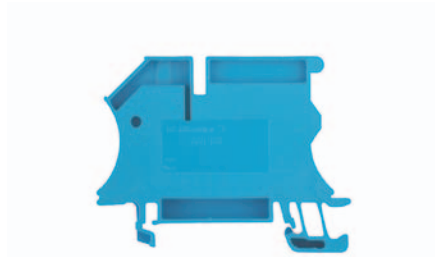

12 x 60 x 47	NT
101 / 25	
1.5 ... 25	

IEC 60947-7-1 / VDE 0611-4

IEC	UL	CSA	EN 50019
400			
76			
16			
	6 / 3		
	B7 / V-0		

Rated connection

1.5...16 / 1.5...25
1.5...16 / 1.5...16
12 / 5.5 x 1.0
1.2...2.2 (M 4)

Tightening torque N-disconnector 0,8...1,6 Nm
25mm² has to be inserted with 2,2 Nm

WNT 35N

35 mm²

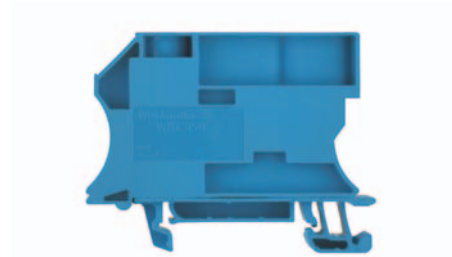

16 x 66 x 51	NT
150 / 50	
2.5 ... 50	

IEC 60947-7-1 / VDE 0611-4

IEC	UL	CSA	EN 50019
400			
125			
35			
	6 / 3		
	B8 / V-0		

Rated connection

2.5...16 / 2.5...50
2.5...35 / 2.5...35
18 / 6.5 x 1.2
2.5...5.0 Nm (M 6)

Tightening torque N-disconnector 1,2...2,4 Nm

Type	Qty.	Order No.
WNT 16N 10X3	50	1019000000

Type	Qty.	Order No.
WNT 35N 10X3	20	1718550000

Type	Current [A]	Qty.	Order No.

Width [mm]	

Width [mm]	
WHP 2.5-35N/10x3 BL	2 20 1050280000

Width [mm]	

Width [mm]	
WEW-35/2	8 100 1061200000

Width [mm]	
SD 1.0X5.5X150	10 9008350000

Width [mm]	
SSCH 10X3X1000 CU/SN	1 0348900000

Width [mm]	
ZB 4	5.6 50 0316500000
ZB 16 ZKSC	10 50 0316600000
ZB 35/M6X16	14 20 0266500000

Width [mm]	

Width [mm]	
WS 12/6,5 / DEK 5	
For PEN-bridges see section Accessories W-series	

Type	Current [A]	Qty.	Order No.

Width [mm]	

Width [mm]	
WHP 2.5-35N/10x3 BL	2 20 1050280000

Width [mm]	

Width [mm]	
WEW-35/2	8 100 1061200000

Width [mm]	
SD 1.2x6.5x150	10 9009010000

Width [mm]	
SSCH 10X3X1000 CU/SN	1 0348900000

Width [mm]	
ZB 4	5.6 50 0316500000
ZB 16 ZKSC	10 50 0316600000
ZB 35/M6X16	14 20 0266500000

Width [mm]	

Width [mm]	
WS 12/6,5 / DEK 5	
For PEN-bridges see section Accessories W-series	

Installation terminals

WNT 70N

70 mm²

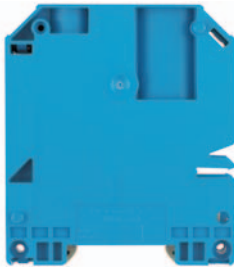

20.5 x 75 x 86
207 / 95
10 ... 95

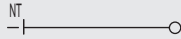

IEC 60947-7-1 / VDE 0611-4

IEC	UL	CSA	EN 50019
400	600		
192	175		
70	AWG 6 ...2/0		
	6 / 3		
	B11 / V-0		



Rated connection

10...16 / 10...95
10...70 / 10...70
22 / S6 (DIN 6911)
6.0...1 Nm (hexagon) (M 8)

Tightening torque N-disconnector 2,5..5,0 Nm

Type	Qty.	Order No.
WNT 70N/35	10	9512210000

Type	Current [A]	Qty.	Order No.
Width [mm]			
Width [mm]			
WHP 2.5-35N/10x3 BL	2	20	1050280000
Width [mm]			
WEW-35/2	8	100	1061200000
Width [mm]			
SSCH 10X3X1000 CU/SN		1	0348900000
Width [mm]			
ZB 4	5.6	50	0316500000
ZB 16 ZKSC	10	50	0316600000
ZB 35/M6X16	14	20	0266500000

DEK 5 / WS 12/6,5

For PEN-bridges see section Accessories W-series

Articles with coloured order number are kept permanently in stock at the central warehouse in Germany. Delivery times see page X.2

Measuring-disconnecting terminals

Measuring-disconnecting terminals

Different current transformer circuits - for example to exchange measuring instruments or kilowatt-hour meters - can be produced.

When using ATEX certified components in hazardous area applications the installation instructions and the rated data for accessories in the technical appendix must be considered.

Width/Length/Height with TS35x7.5	mm
Max. current / max. cond. cross-section	A/mm ²
Max. clamping range	mm ²

Technical data

Rated data	
Rated voltage	V
Rated current	A
Rated cross-section	mm ²
Rated impulse voltage / Pollution severity	kV/-
Plug gauge IEC 60-947-1 / flammability class acc. UL94	
Approvals	

Clampable conductors (H05V/H07V)

Solid / stranded	mm ²
Flexible / flexible w. wire end ferrule	mm ²
Tightening torque range (clamping screw)	Nm
Tightening torque range disconnecter	Nm
Stripping length / blade size	mm / -

Information

Ordering data

Version	
dark beige Wemid	With socket
	Without socket

Information

Accessories

Cross-connection	
ZQV: pluggable cross-connection	2-pole
WQV: screwable cross-connection	3-pole
QL: screwable cross-connection	4-pole
	10-pole / 32-pole
Connecting sleeve for cross-conn. QL	
Fixing screw for cross-conn. QL	

End plate / partition	
dark beige Wemid	End plate
	Partition

Cross-connection slider	
	2-pole
	3-pole
	4-pole
Connecting sleeve for QVS	
Fixing screw for QVS	

Testing	
	Test plug
	Socket, yellow
	Socket, green
	Socket, violet
	Socket, blue

Other accessories	
	Lockout device
	Short-circuit-plug, 2-pole
Without insulating cap	Socket

Marking systems (see large assortment in chapter M)	
	Tags

For detailed information on additional accessories and usage instructions see chapter accessories.

WTL 4

4 mm²

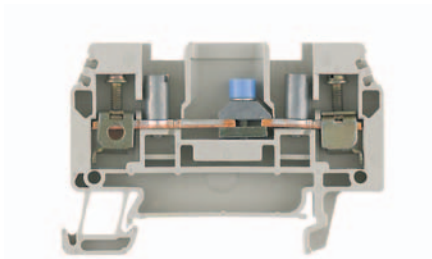

6.1 x 61.3 x 40.7
41 / 6
0.13 ... 6

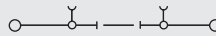

IEC 60947-7-1 / VDE 0100-537

IEC	UL	CSA	EN 50019
500	300	300	
32	28	28	
4	AWG 26 ... 10	AWG 26...10	
		6 / 3	
		A3 / V-0	



Rated connection	Additional connection
0.5...6 / 1.5...4	
0.5...4 / 0.5...4	
0.4...0.7 (M 2.5)	
0.4...0.7	
10 / 3.5 x 0.6	

Usage as disconnect terminal 400V.

Type	Qty.	Order No.
WTL 4/STB	50	1754970000
WTL 4	50	1754960000

Type	Current [A]	Qty.	Order No.
WQV 4/2	41	50	1051960000
WQV 4/3	41	50	1054560000
WQV 4/4	41	50	1054660000
WQV 4/10	41	20	1052060000

Type	Width [mm]	Qty.	Order No.
ZAP/TW 1	2	50	1608740000

QVS 2/4 SAKT4	20	1319260000
VH 16/5/3.5 SAK10-35	50	0309700000
BFSC M3X22 SAKT4	50	1319900000

PS 2.3 RT	20	0180400000
SSP 4 SAKT4	20	1319360000
STB 8.5/5/2.3/M3 SAK2.5	50	0280600000

WS 12/6 / DEK 6

WTL 6/1

6 mm²

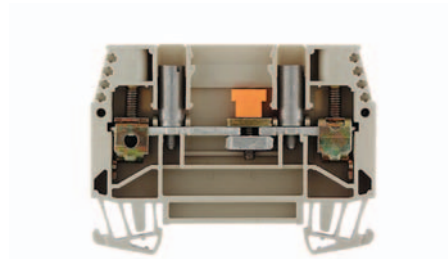

7.9 x 65 x 48.5
57 / 10
0.5 ... 10

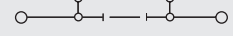

IEC 60947-7-1 / VDE 0100-537

IEC	UL	CSA	EN 50019
800	300	300	
41	45	45	
6	AWG 20 ... 8	AWG 20...8	
		6 / 3	
		A5 / V-0	



Rated connection	Additional connection
0.5...10 / 1.5...10	
0.5...10 / 0.5...6	
0.8...1.6 (M 3.5)	
0.5...0.8	
12 / 4.0 x 0.8	

Usage as disconnect terminal 400V.

Type	Qty.	Order No.
WTL 6/1/STB	50	1016900000
WTL 6/1	50	1016700000

TS32 version on request

Type	Current [A]	Qty.	Order No.
QL 2 SAK6N	41	50	0194300000
QL 3 SAK6N	41	50	0194400000
QL 4 SAK6N	36	50	0194500000
QL 10 SAK6N	36	20	0338300000
VH 12/4.9/3.3 SAK6N	100	0249000000	
KISC M3X20 SAK10 CU5	100	0377100000	

Type	Width [mm]	Qty.	Order No.
WAP WTL6/1	1.5	20	1068300000
WTW WTL6/1 DB	1.5	20	1068400000

QVS 2 SAKT1+2	20	0307300000
QVS 3 SAKT1+2	20	0329300000
QVS 4 SAKT1+2	20	0307400000
VH 19/6/4.2 SAKT1	50	0318000000
BS 25 IH/GE SAKT1	50	0335700000

PS 4 F.STB 4	20	0299600000
STB 35 IH/GE	50	0389000000
STB 35 IH/GN	50	0388900000
STB 35 IH/VI	50	0389100000
STB 35 IH/BL	50	0388700000

SSP 3 SAKT1	100	0531760000
QS 2/8/4	20	0270960000
STB 14/D6/4/M3 SAK10	50	1699000000

DEK 8 / WS 12/6,5

Measuring-disconnecting terminals

WTD 6/1

6 mm²

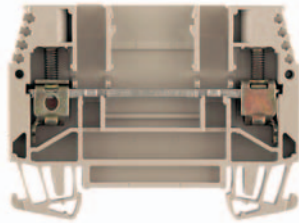

7.9 x 65 x 48.5
57 / 10
0.5 ... 10



IEC 60947-7-1 / VDE 0100-537

IEC	UL	CSA	EN 50019
800	300	300	
41	45	45	
6	AWG 20 ...8	AWG 20...8	
6 / 3			
A5 / V-0			



Rated connection	Additional connection
0.5...10 / 1.5...10	
0.5...10 / 0.5...6	
0.8...1.6 (M 3.5)	
0.5...0.8	
12 / 4.0 x 0.8	

Usage as disconnect terminal 400V.

WTQ 6/1

6 mm²

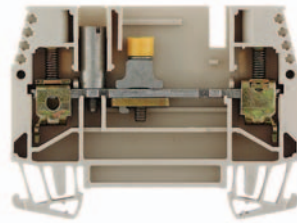

7.9 x 65 x 48.5
57 / 10
0.5 ... 10



IEC 60947-7-1 / VDE 0100-537

IEC	UL	CSA	EN 50019
500	300	300	
41	45	45	
6	AWG 20 ...8	AWG 20...8	
6 / 3			
A5 / V-0			



Rated connection	Additional connection
0.5...10 / 1.5...10	
0.5...10 / 0.5...6	
0.8...1.6 (M 3.5)	
0.5...0.8	
12 / 4.0 x 0.8	

Usage as disconnect terminal 400V.

WTL 6/3

6 mm²



7.9 x 87 x 65
57 / 10
0.5 ... 10

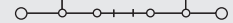

IEC 60947-7-1 / VDE 0100-537

IEC	UL	CSA	EN 50019
500	300	300	
41	45	45	
6	AWG 20 ...8	AWG 20...8	
6 / 3			
A5 / V-0			



Rated connection	Additional connection
0.5...10 / 1.5...10	
0.5...10 / 0.5...6	
0.8...1.6 (M 3.5)	
0.5...0.8	
12 / 4.0 x 0.8	

Usage as disconnect terminal 400V.

Type	Qty.	Order No.
WTD 6/1	50	1017100000
TS32 version on request		

Type	Qty.	Order No.
WTQ 6/1/STB	50	1018100000
WTQ 6/1	50	1017900000
TS32 version on request		

Type	Qty.	Order No.
WTL 6/3/STB	50	1018600000
WTL 6/3	50	1018800000
TS32 version on request		

Type	Current [A]	Qty.	Order No.
QL 2 SAK6N	41	50	0194300000
QL 3 SAK6N	41	50	0194400000
QL 4 SAK6N	36	50	0194500000
QL 10 SAK6N	36	20	0338300000
VH 12/4.9/3.3 SAK6N	100		0249000000
KISC M3X20 SAK10 CU5	100		0377100000
Width [mm]			
WAP WTL6/1	1.5	20	1068300000
WTW WTL6/1 DB	1.5	20	1068400000
QVS 2 SAKT1+2	20		0307300000
QVS 3 SAKT1+2	20		0329300000
QVS 4 SAKT1+2	20		0307400000
VH 19/6/4.2 SAKT1	50		0318000000
BS 25 IH/GE SAKT1	50		0335700000
PS 4 F.STB 4	20		0299600000
QS 2/8/4	20		0270960000
STB 14/D6/4/M3 SAK10	50		0169900000
DEK 8 / WS 12/6,5			

Type	Current [A]	Qty.	Order No.
QL 2 SAK6N	41	50	0194300000
QL 3 SAK6N	41	50	0194400000
QL 4 SAK6N	36	50	0194500000
QL 10 SAK6N	36	20	0338300000
VH 12/4.9/3.3 SAK6N	100		0249000000
KISC M3X20 SAK10 CU5	100		0377100000
Width [mm]			
WAP WTL6/1	1.5	20	1068300000
WTW WTL6/1 DB	1.5	20	1068400000
WKB 1/2	50		1604280000
WKB 1/3	50		1604300000
WKB 1/4	50		1604320000
PS 4 F.STB 4	20		0299600000
SSP 3 SAKT1	100		0531760000
QS 2/8/4	20		0270960000
STB 14/D6/4/M3 SAK10	50		0169900000
WS 12/6,5 / DEK 8			

Type	Current [A]	Qty.	Order No.
WQV 6/2	57	50	1052360000
WQV 6/3	57	50	1054760000
WQV 6/4	57	50	1054860000
WQV 6/10	57	20	1052260000
Width [mm]			
WKS 1/2	50		1604270000
WKS 1/3	50		1604290000
WKS 1/4	50		1604310000
PS 4 F.STB 4	20		0299600000
STB 21.6/IH/GE WTL6/3	50		1071010000
STB 21.6/IH/GN WTL6/3	50		1071020000
STB 21.6/IH/VI WTL6/3	50		1071030000
STB 21.6/IH/BL WTL6/3	50		1071080000
SSP WTL6/2	100		1604200000
DEK 8 / WS 12/6,5			

Articles with coloured order number are kept permanently in stock at the central warehouse in Germany. Delivery times see page X.2

Pluggable terminals

Spade connection

Terminals with push-on tabs acc. to EN 61210 / VDE 0613-6.

When using ATEX certified components in hazardous area applications the installation instructions and the rated data for accessories in the technical appendix must be considered.

Width/Length/Height with TS35x7.5	mm
Max. current / max. cond. cross-section	A/mm ²
Max. clamping range	mm ²

Technical data

Rated data	
Rated voltage	V
Rated current	A
Rated cross-section	mm ²
Rated impulse voltage / Pollution severity	kV/-
Plug gauge IEC 60-947-1 / flammability class acc. UL94	
Approvals	

Clampable conductors (H05V/H07V)

Solid / stranded	mm ²
Flexible / flexible w. wire end ferrule	mm ²
Tightening torque range (clamping screw)	Nm
Stripping length / blade size	mm / -

2 clampable conductors of equal cross-section

Solid / stranded	mm ²
Flexible / flexible w. wire end ferrule	mm ²

Information

Ordering data

Version	
dark beige Wemid	
blue Wemid	

Information

Accessories

Cross-connection, pluggable

	(ZQV 2.5N/4)	2-pole	
		3-pole	
		4-pole	
		10-pole	
		41-/50-pole	

Cross-connection, screwable

	(WQV 2.5-3)	2-pole	
		3-pole	
		4-pole	
		10-pole	

End plate / partition

End plate	dark beige Wemid	
	blue Wemid	
Partition	dark beige Wemid	
	blue Wemid	

End bracket

	dark beige	
--	------------	--

Testing

For testing of wired terminal strips	Standard version	
	With spigot	

Cover

	With elec. shock warn. symbol	
	neutral	

Marking systems (see large assortment in chapter M)

	Tags	
--	------	--

For detailed information on additional accessories and usage instructions see chapter accessories.

WDU 2.5 F

2.5 mm²

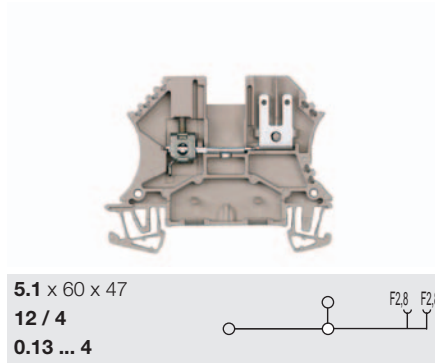

IEC 60947-7-1 / IEC 61210

IEC	UL	CSA	EN 50019
500	300	300	
12	10	10	
2.5	AWG 26 ...12	AWG 26...12	
		6 / 3	
		A3 / V-0	



Rated connection

0.5...4 / 1.5...4

0.5...4 / 0.5...2.5 1...1

0.4...0.8 (M 2.5)

10 / 3.5 x 0.6

0.5...1.5

0.5...1.5 / 0.5...1.5

With insulating sleeves for spade connectors the voltage increases to 500V. The current is limited by 2.8mm spade connectors with conductor 1mm².

Type	Qty.	Order No.
WDU 2.5 F 2X2.8	100	1021800000

Conductor 2.5 mm² with wire end ferrule with plastic collar only with diameter optimised collar (Order No. 1333100000, Qty. 500)

WDU 2.5 FF 2x2.8

1 mm²

Push-on tabs right and left

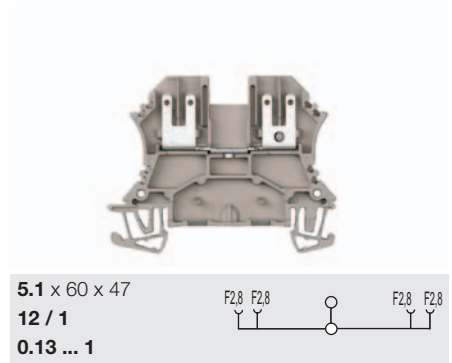

IEC 60947-7-1 / IEC 61210

IEC	UL	CSA	EN 50019
500	300	300	
12	10	10	
1	AWG 22 ...12	AWG 26...12	
		6 / 3	
		/ V-0	



Rated connection

1...1

With insulating sleeves for spade connectors the voltage increases to 500V. The current is limited by 2.8mm spade connectors.

Type	Qty.	Order No.
WDU 2.5 FF 2X2.8	100	1021900000

Technical data refer to 2.8mm spade connectors with conductor 1mm²

Type

Type	Current [A]	Qty.	Order No.

Current [A]			
WQV 2.5/2	32	50	1053660000
WQV 2.5/3	32	50	1053760000
WQV 2.5/4	32	50	1053860000
WQV 2.5/10	32	20	1054460000

Width [mm]			
WAP 2.5-10	1.5	50	1050000000
WAP 2.5-10 BL	1.5	50	1050080000
WAP 16+35 WTW 2.5-10	1.5	20	1050100000
WAP 16+35 WTW 2.5-10 BL	1.5	20	1050180000

Width [mm]			
WEW-35/2	8	100	1061200000

WS 12/5 / DEK 5

Insulating sleeves for spade connectors 2.8mm order no. 0386060000 (Qty. 100)

Type

Type	Current [A]	Qty.	Order No.

Current [A]			
WQV 2.5/2	32	50	1053660000
WQV 2.5/3	32	50	1053760000
WQV 2.5/4	32	50	1053860000
WQV 2.5/10	32	20	1054460000

Width [mm]			
WAP 2.5-10	1.5	50	1050000000
WAP 2.5-10 BL	1.5	50	1050080000
WAP 16+35 WTW 2.5-10	1.5	20	1050100000
WAP 16+35 WTW 2.5-10 BL	1.5	20	1050180000

Width [mm]			
WEW-35/2	8	100	1061200000

WS 12/5 / DEK 5

Insulating sleeves for spade connectors 2.8mm order no. 0386060000 (Qty. 10)

Pluggable terminals

WDK 2.5 F

2.5 mm²

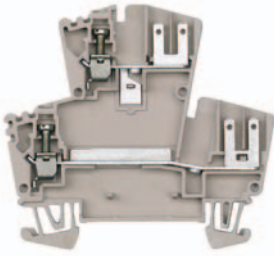

5.1 x 69.5 x 63
12 / 4
0.13 ... 4

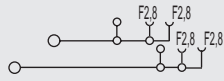

IEC 60947-7-1 / IEC 61210

IEC	UL	CSA	EN 50019
400	300	300	
12	10	10	
2.5	AWG 22 ...12	AWG 26...12	
6 / 3			
A3 / V-0			



Rated connection	Additional connection
0.5...4 / 1.5...4	
0.5...4 / 0.5...2.5	1...1
0.4...0.6 (M 2.5)	
10 / 3.5 x 0.6	

0.5...1.5
0.5...1.5 / 0.5...1.5

With insulating sleeves for spade connectors the voltage increases to 500V. The current is limited by 2.8mm spade connectors with conductor 1mm².

Type	Qty.	Order No.
WDK 2.5 F	100	1021600000
WDK 2.5 F BL	100	1021680000

Conductor 2.5 mm² with wire end ferrule with plastic collar only with diameter optimised collar (Order No. 1333100000, Qty. 500)

Type	Current [A]	Qty.	Order No.

Current [A]			
WQV 2.5/2	32	50	1053660000
WQV 2.5/3	32	50	1053760000
WQV 2.5/4	32	50	1053860000
WQV 2.5/10	32	20	1054460000

Width [mm]			
WAP WDK2.5	1.5	20	1059100000
WAP WDK2.5 BL	1.5	20	1059180000
WTW EN	1.5	20	1058800000

Width [mm]			
WEW-35/2	8	100	1061200000

DEK 5 / WS 8/5

Insulating sleeves for spade connectors 2.8mm order no. 0386060000 (Qty. 100)

WDK 2.5 FF

1 mm²

Flat plugs right and left

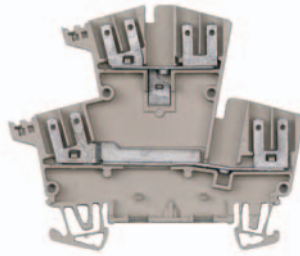

5.1 x 75.5 x 63
12 / 1
0.13 ... 1



IEC 60947-7-1 / IEC 61210

IEC	UL	CSA	EN 50019
400	300	300	
12	10	10	
1	AWG 22 ...12	AWG 26...12	
6 / 3			
/ V-0			



Rated connection	Additional connection
1...1	

0.5...1.5
0.5...1.5 / 0.5...1.5

With insulating sleeves for spade connectors the voltage increases to 500V. The current is limited by 2.8mm spade connectors.

Type	Qty.	Order No.
WDK 2.5 FF	100	1021700000
WDK 2.5 FF BL		1021780000

Conductor 2.5 mm² with wire end ferrule with plastic collar only with diameter optimised collar (Order No. 1333100000, Qty. 500)

Type	Current [A]	Qty.	Order No.

Current [A]			
WQV 2.5/2	32	50	1053660000
WQV 2.5/3	32	50	1053760000
WQV 2.5/4	32	50	1053860000
WQV 2.5/10	32	20	1054460000

Width [mm]			
WAP WDK2.5	1.5	20	1059100000
WAP WDK2.5 BL	1.5	20	1059180000
WTW EN	1.5	20	1058800000

Width [mm]			
WEW-35/2	8	100	1061200000

WS 8/5 / DEK 5

Insulating sleeves for spade connectors 2.8mm order no. 0386060000 (Qty. 100)

WDK 2.5 FV

2.5 mm²

Double level push-on tab terminal with internal cross-connection

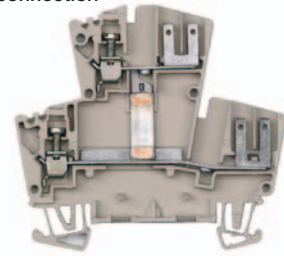

5.1 x 69.5 x 63
12 / 4
0.13 ... 4



IEC 60947-7-1 / IEC 61210

IEC	UL	CSA	EN 50019
400	300	300	
12	10	10	
2.5	AWG 22 ...12	AWG 26...12	
6 / 3			
A3 / V-0			



Rated connection	Additional connection
0.5...4 / 1.5...4	
0.5...4 / 0.5...2.5	1...1
0.4...0.6 (M 2.5)	
10 / 3.5 x 0.6	

0.5...1.5
0.5...1.5 / 0.5...1.5

With insulating sleeves for spade connectors the voltage increases to 500V. The current is limited by 2.8mm spade connectors with conductor 1mm².

Type	Qty.	Order No.
WDK 2.5 FV	100	1022400000

Conductor 2.5 mm² with wire end ferrule with plastic collar only with diameter optimised collar (Order No. 1333100000, Qty. 500)

Type	Current [A]	Qty.	Order No.

Current [A]			
WQV 2.5/2	32	50	1053660000
WQV 2.5/3	32	50	1053760000
WQV 2.5/4	32	50	1053860000
WQV 2.5/10	32	20	1054460000

Width [mm]			
WAP WDK2.5	1.5	20	1059100000
WAP WDK2.5 BL	1.5	20	1059180000
WTW EN	1.5	20	1058800000

Width [mm]			
WEW-35/2	8	100	1061200000

WS 8/5 / DEK 5

Insulating sleeves for spade connectors 2.8mm order no. 0386060000 (Qty. 100)

Pluggable terminals

Connector connection

When using ATEX certified components in hazardous area applications the installation instructions and the rated data for accessories in the technical appendix must be considered.

Width/Length/Height with TS35x7.5	mm
Max. current / max. cond. cross-section	A/mm ²
Max. clamping range	mm ²

Technical data

Rated data	
Rated voltage	V
Rated current	A
Rated cross-section	mm ²
Rated impulse voltage / Pollution severity	kV/-
Plug gauge IEC 60-947-1 / flammability class acc. UL94	
Approvals	

Clampable conductors (H05V/H07V)	
Solid / stranded	mm ²
Flexible / flexible w. wire end ferrule	mm ²
Tightening torque	Nm
Stripping length / blade size	mm / -

2 clampable conductors of equal cross-section	
Solid / stranded	mm ²
Flexible / flexible w. wire end ferrule	mm ²

Information
Dimensions with socket connector BLZ: length 57.5mm / height 50mm

Ordering data

Version
dark beige Wernid
blue Wernid

Information
Conductor 2.5 mm ² with wire end ferrule with plastic collar only with diameter optimised collar (Order No. 1333100000, VPE 500)

Accessories

Cross-connection	
pluggable (ZQV)	screwable (WQV)
	2-pole
	3-pole
	4-pole
	10-pole

End plate	
	With spigot
	without spigot

Fixing block for socket connector	
	With spigot
	without spigot

Socket connectors	
	4-pole
	6-pole
	8-pole
With dovetail on the side	4-pole
With dovetail on the side	6-pole
With dovetail on the side	8-pole

Other accessories	
	Cover for unused pins
	Coding element

Marking systems (see large assortment in chapter M)	
	Tags

For detailed information on additional accessories and usage instructions see chapter accessories.	
	Conductor 2.5 mm ² with wire end ferrule with plastic collar only with diameter optimised collar (Order No. 1333100000, VPE 500)

WDU 1.5 BLZ 5.08 WQV

1.5 mm²

Screwable cross-connection



5.08 x 49 x 37.5		
16 / 4		
0.13 ... 4		

IEC 60947-7-1 / IEC 61984

IEC	UL	CSA	EN 50019
250	300	300	
16	20	10	
1.5	AWG 26 ...16	AWG 26...16	
		4 / 3	
		A3 / V-0	



Rated connection	Plug connector
0.5...4 / 1.5...4	0.5...2.5 / 1.5...2.5
0.5...4 / 0.5...2.5	0.5...2.5 / 0.5...2.5
0.4...0.6 (M 2.5)	0.4...0.5 (M 2.5)
10 / 3.5 x 0.6	7 / 3.5 x 0.6

0.5...1.5
0.5...1.5 / 0.5...1.5

Information
Dimensions with socket connector BLZ: length 57.5mm / height 50mm

Type	Qty.	Order No.
WDU 1.5/BLZ 5.08	100	1577340000
WDU 1.5/BLZ 5.08 BL	100	1596900000
WDU 1.5 BLA order no. 1577260000 (VPE 100). Technical data like WDU 1.5 BLZ.		

Type	Current [A]	Qty.	Order No.
WQV 2.5/2	32	50	1053660000
WQV 2.5/3	32	50	1053760000
WQV 2.5/4	32	50	1053860000
WQV 2.5/10	32	20	1054460000

Width [mm]	
WAP WDU 1.5/BLZ/ZA	2.5 50 1577320000
WAP WDU 1.5/BLZ	2.5 50 1577330000

WBB ZA WDU1.5/BL 10/10	10	1068260000
WBB WDU 1.5/BL...	10	1068160000

BLZ 5.08/4 SN OR	100	1526660000
BLZ 5.08/6 SN OR	50	1526860000
BLZ 5.08/8 SN OR	50	1527060000
BLZ 5.08/4B SN OR	100	1528960000
BLZ 5.08/6B SN OR	50	1529160000
BLZ 5.08/8B SN OR	50	1529360000

WAD WDU 1.5/BL	20	1577400000
BLZ-KO SW	50	1545710000

WS 12/5 / DEK 5

Conductor 2.5 mm ² with wire end ferrule with plastic collar only with diameter optimised collar (Order No. 1333100000, VPE 500)

WDU 1.5 BLZ 5.08 ZQV

1.5 mm²

Pluggable cross-connection

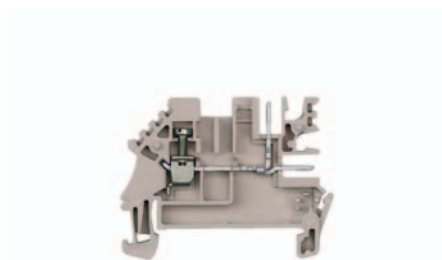

5.08 x 49 x 37.5		
16 / 4		
0.13 ... 4		

IEC 60947-7-1 / IEC 61984

IEC	UL	CSA	EN 50019
250	300	300	
16	20	10	
1.5	AWG 26 ...16	AWG 26...16	
		4 / 3	
		A3 / V-0	



Rated connection	Plug connector
0.5...4 / 1.5...4	0.5...2.5 / 1.5...2.5
0.5...4 / 0.5...2.5	0.5...2.5 / 0.5...2.5
0.4...0.6 (M 2.5)	0.4...0.5 (M 2.5)
10 / 3.5 x 0.6	7 / 3.5 x 0.6

0.5...1.5
0.5...1.5 / 0.5...1.5

Information
Dimensions with socket connector BLZ: length 57.5mm / height 50mm

Type	Qty.	Order No.
WDU 1.5/ZQV/BLZ 5.08	100	1784460000
WDU 1.5/ZQV/BLZ 5.08 BL	100	1784470000
Conductor 2.5 mm ² with wire end ferrule with plastic collar only with diameter optimised collar (Order No. 1333100000, VPE 500)		

Type	Current [A]	Qty.	Order No.
ZQV 2.5N/2 GE	24	60	1693800000
ZQV 2.5N/3 GE	24	60	1693810000
ZQV 2.5N/4 GE	24	60	1693820000
ZQV 2.5N/10 GE	24	20	1693880000

Width [mm]	
WAP WDU 1.5/BLZ/ZA	2.5 50 1577320000
WAP WDU 1.5/BLZ	2.5 50 1577330000

WBB ZA WDU1.5/BL 10/10	10	1068260000
WBB WDU 1.5/BL...	10	1068160000

BLZ 5.08/4 SN OR	100	1526660000
BLZ 5.08/6 SN OR	50	1526860000
BLZ 5.08/8 SN OR	50	1527060000
BLZ 5.08/4B SN OR	100	1528960000
BLZ 5.08/6B SN OR	50	1529160000
BLZ 5.08/8B SN OR	50	1529360000

WAD WDU 1.5/BL	20	1577400000
BLZ-KO SW	50	1545710000

WS 12/5 / DEK 5

Conductor 2.5 mm ² with wire end ferrule with plastic collar only with diameter optimised collar (Order No. 1333100000, VPE 500)

Pluggable terminals

WDK 2.5 BLZ/5.08

2.5 mm²

Double terminal pitch 5.08

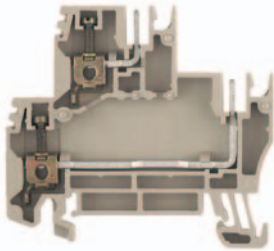

5.08 x 58 x 53

18 / 4

0.13 ... 4

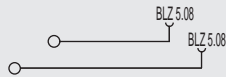

IEC 60947-7-1 / IEC 61984

IEC	UL	CSA	EN 50019
250	300	300	
16.5	10	24	
2.5	AWG 22 ...12	AWG 26...10	
	4 / 3		
	A3 / V-0		



Rated connection	Plug connector
0.5...4 / 1.5...2.5	0.5...2.5 / 1.5...2.5
0.5...4 / 0.5...2.5	0.5...2.5 / 0.5...2.5
0.4...0.8 (M 2.5)	0.4...0.5 (M 2.5)
10 / 3.5 x 0.6	7 / 3.5 x 0.6

0.5...1.5

0.5...1.5 / 0.5...1.5

Conductor 2.5 mm² with wire end ferrule with plastic collar only with diameter optimised collar (Order No. 1333100000, VPE 500)

WDU 2.5 BLZ/7.62

2.5 mm²

Pitch 7.62



7.62 x 49 x 37.5

24 / 4

0.13 ... 4

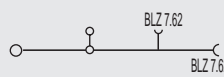

IEC 60947-7-1 / IEC 61984

IEC	UL	CSA	EN 50019
400			
21.5			
2.5			
	6 / 3		
	A3 / V-0		



Rated connection	Plug connector
0.5...4 / 1.5...2.5	0.5...2.5 / 1.5...2.5
0.5...2.5 / 0.5...2.5	0.5...2.5 / 0.5...2.5
0.4...0.8 (M 2.5)	0.4...0.5 (M 2.5)
10 / 3.5 x 0.6	7 / 3.5 x 0.6

0.5...1.5

0.5...1.5 / 0.5...1.5

Max. current 24 A only up to 20°C ambient temperature

WDK 2.5 BLZ/7.62

2.5 mm²

Double terminal pitch 7.62

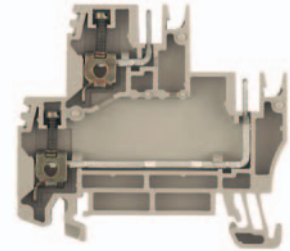

7.62 x 58 x 53

20 / 4

0.13 ... 4



IEC 60947-7-1 / IEC 61984

IEC	UL	CSA	EN 50019
400			
18.5			
2.5			
	6 / 3		
	A3 / V-0		



Rated connection	Plug connector
0.5...4 / 1.5...4	0.5...2.5 / 1.5...2.5
0.5...4 / 0.5...2.5	0.5...2.5 / 0.5...2.5
0.4...0.8 (M 2.5)	0.4...0.5 (M 2.5)
10 / 3.5 x 0.6	7 / 3.5 x 0.6

0.5...1.5

0.5...1.5 / 0.5...1.5

Max. current 20A only up to 20°C ambient temperature; dimensions including socket connector BLZ: length 60mm / height 65mm

Type	Qty.	Order No.
WDK 2.5/BLZ/5.08/ZA	100	1034400000

Dimensions with socket connector BLZ: length 60mm / height 65mm; max. current 18A only up to 20°C ambient temperature

Type	Qty.	Order No.
WDU 2.5/BLZ/7.62	100	1038900000

Conductor 2.5 mm² with wire end ferrule with plastic collar only with diameter optimised collar (Order No. 1333100000, VPE 500)

Type	Qty.	Order No.
WDK 2.5 BLZ/7.62/ZA	50	1038500000

Conductor 2.5 mm² with wire end ferrule with plastic collar only with diameter optimised collar (Order No. 1333100000, VPE 500)

Type	Current [A]	Qty.	Order No.

Width [mm]			
WAP WDK2.5/BLZ/M.ZA	5.08	20	1070100000
WAP WDK2.5/BLZ/M.ZA	5.08	20	1070100000

WBB ZA WDK2.5/BL5.08	10	1072760000
WBB WDK2.5/BL5.08	10	1072660000

BLZ 5.08/4 SN OR	100	1526660000
BLZ 5.08/6 SN OR	50	1526860000
BLZ 5.08/8 SN OR	50	1527060000
BLZ 5.08/4B SN OR	100	1528960000
BLZ 5.08/6B SN OR	50	1529160000
BLZ 5.08/8B SN OR	50	1529360000

WAD WDU1.5/BL	20	1577400000
BLZ-KO SW	50	1545710000

DEK 5 / WS 8/5

Cross-connection WQB A lying outside see section Accessories W-series Electrical distribution

Type	Current [A]	Qty.	Order No.

Width [mm]			
WAP WDU1.5/BLZ/ZA	2.5	50	1577320000
WAP WDU1.5/BLZ	2.5	50	1577330000

WBB ZA WDU2.5/BLZ7.62	10	1073600000
WBB WDU2.5/BLZ7.62	10	1073500000

BLZ 5.08/4 SN OR	100	1526660000
BLZ 5.08/6 SN OR	50	1526860000
BLZ 5.08/8 SN OR	50	1527060000
BLZ 5.08/4B SN OR	100	1528960000
BLZ 5.08/6B SN OR	50	1529160000
BLZ 5.08/8B SN OR	50	1529360000

WAD WDU1.5/BL	20	1577400000
BLZ-KO SW	50	1545710000

DEK 5 / WS 12/6,5

Type	Current [A]	Qty.	Order No.

Width [mm]			
WAP WDK2.5/BLZ/O.ZA	5.08	20	1070000000
WAP WDK2.5/BLZ/O.ZA	5.08	20	1070000000

WBB ZA WDK2.5/BLZ7.62	10	1072960000
WBB WDK2.5/BLZ7.62	10	1072860000

BLZ 5.08/4 SN OR	100	1526660000
BLZ 5.08/6 SN OR	50	1526860000
BLZ 5.08/8 SN OR	50	1527060000
BLZ 5.08/4B SN OR	100	1528960000
BLZ 5.08/6B SN OR	50	1529160000
BLZ 5.08/8B SN OR	50	1529360000

WAD WDU1.5/BL	20	1577400000
BLZ-KO SW	50	1545710000

DEK 5 / WS 12/6,5

Articles with coloured order number are kept permanently in stock at the central warehouse in Germany. Delivery times see page X.2

Initiator and actuator terminals

Initiator and actuator terminals

Three terminals in one! Weidmüller's cost effective initiator and actuator terminals.

When using ATEX certified components in hazardous area applications the installation instructions and the rated data for accessories in the technical appendix must be considered.

Width/Length/Height with TS35x7.5	mm
Max. current / max. cond. cross-section	A/mm ²
Max. clamping range	mm ²

Technical data

Rated data	
Rated voltage	V
Rated current	A
Rated cross-section	mm ²
Rated impulse voltage / Pollution severity	kV/-
Plug gauge IEC 60-947-1 / flammability class acc. UL94	
Approvals	
Electronic fixtures	
Diode current / diode voltage	V / A
LED-voltage, LED-current, polarity	V / mA / -
Resistance	-N

Clampable conductors (H05V/H07V)	
Solid / stranded	mm ²
Flexible / flexible w. wire end ferrule	mm ²
Tightening torque range (clamping screw)	Nm
Stripping length / blade size	mm / -

Information

Ordering data

Version	
Design of terminal	dark beige Wemid
see circuit diagram above	green Wemid
	Dark beige Wemid (LED red)
	Dark beige Wemid (LED green)
Information	

Accessories

Cross-connection, pluggable	
	2-pole
	3-pole
	4-pole
	10-pole
	50-pole

Cross-connection, screwable	
	2-pole
	3-pole
	4-pole
	10-pole

End plate / partition	dark beige Wemid
------------------------------	------------------

End bracket	dark beige / beige
--------------------	--------------------

Screwdriver	w. cutting device "swifty set"
	Standard version

Reducing sleeves	for conductors < 0.5mm ² / AWG 20
	for conductors < 1.0mm ² / AWG 18

Marking systems (see large assortment in chapter M)	Tags
--	------

For detailed information on additional accessories and usage instructions see chapter accessories.

DLD 2.5

2.5 mm²

Voltage supply

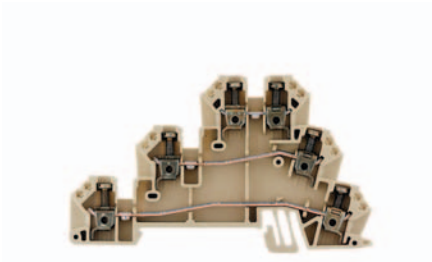

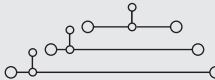
6.1 x 82 x 49	
24 / 4	
0.13 ... 4	

IEC 60947-7-1

IEC	UL	CSA	EN 50019
250	300	300	
24	10	10	
2.5	AWG 22 ...12	AWG 26...12	
		4 / 3	
		A3 / V-0	



Rated connection	Additional connection
0.5...4 / 1.5...4	
0.5...4 / 0.5...2.5	
0.4...0.6 (M 2.5)	
7 / 3.5 x 0.6	

The rated voltage is reduced to 30 V ac, if the cross-connection is used to bypass a pole with a different potential.

Type	Qty.	Order No.
DLD 2.5 DB	50	1784180000

Blue-coloured version Order No. 6269250000 (Qty. 50)

Type	Current [A]	Qty.	Qty.

Current [A]			
Q 2 DLI	20	50	1312500000
Q 3 DLI	20	50	1312600000
Q 4 DLI	20	50	1312700000
Q 4 DLI	20	50	1312700000

Width [mm]			
AP DLD2.5 DB	1.5	20	1784210000
EW 35	8.5	50	0383560000

SD 0.6X3.5X100		10	9008330000
----------------	--	----	-------------------

DEK 6			
-------	--	--	--

Partition disc TSCH 1 Order No. 0319160000 (Qty. 100)
Partial end plate TEAP DLD2.5 DB Order No. 1784220000 (Qty. 20)

DLD 2.5 PE

2.5 mm²

Lower level grounded

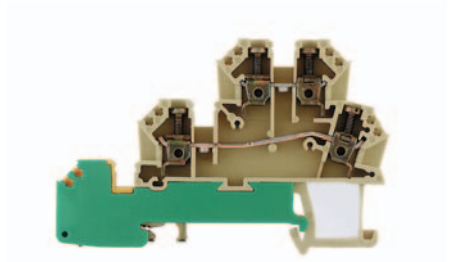

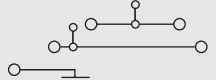
6.1 x 74.5 x 49	
17.5 / 4	
0.13 ... 4	

IEC 60947-7-1

IEC	UL	CSA	EN 50019
250	300	300	
17.5	10	10	
2.5	AWG 26 ...12	AWG 26...12	
		4 / 3	
		A3	

Rated connection	Additional connection
0.5...4 / 0.5...4	
0.5...4 / 0.5...2.5	
0.4...0.6 (M 2.5)	
7 / 3.5 x 0.6	

If the cross-connection is used to bypass a pole (different potential) or if it is lead via the PE connection, the voltage is reduced to 30 V ac.

Type	Qty.	Order No.
DLD 2.5/PE DB	50	1783790000

Partition disc TSCH 1 Order No. 0319160000 (Qty. 100)
Partial end plate TEAP DLD2.5/PE DB Order No. 1783810000 (Qty. 20)

Type	Current [A]	Qty.	Qty.

Current [A]			
Q 2 DLI	20	50	1312500000
Q 3 DLI	20	50	1312600000
Q 4 DLI	20	50	1312700000
Q 4 DLI	20	50	1312700000

Width [mm]			
AP DLD2.5/PE DB	1.5	20	1783800000
EW 35	8.5	50	0383560000

SD 0.6X3.5X100		10	9008330000
----------------	--	----	-------------------

DEK 6			
-------	--	--	--

Partition disc TSCH 1 Order No. 0319160000 (Qty. 100)
Partial end plate TEAP DLD2.5/PE DB Order No. 1783810000 (Qty. 20)

Initiator and actuator terminals

DLI 2.5

2.5 mm²

Initiator-connection (signal,+,-)

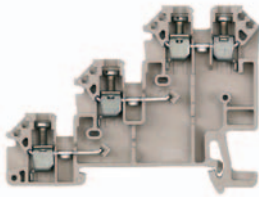

6.1 x 65 x 49
26 / 4
0.13 ... 4

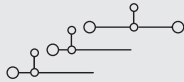

IEC 60947-7-1

IEC	UL	CSA	EN 50019
250	300	300	
24	10	10	
2.5	AWG 22 ...12	AWG 26...12	
	4 / 3		
	A3 / V-0		



DLI 2.5 LD PNP

2.5 mm²

Initiator-connection with LED

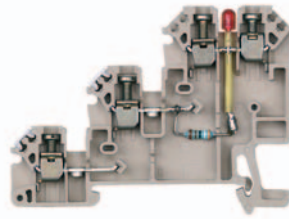

6.1 x 65 x 49
24 / 4
0.13 ... 4

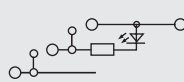

IEC 60947-7-1

IEC	UL	CSA	EN 50019
30	30	30	
24	10	10	
2.5	AWG 22 ...12	AWG 26...12	
	0.8 / 3		
	A3 / V-0		



30 / 5

DLI 2.5 LD NPN

2.5 mm²

Initiator-connection with LED

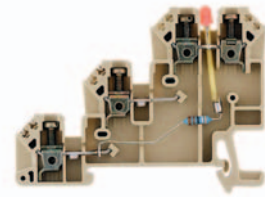

6.1 x 65 x 49
24 / 4
0.13 ... 4

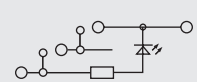

IEC 60947-7-1

IEC	UL	CSA	EN 50019
30	30	30	
24	10	10	
2.5	AWG 22 ...12	AWG 26...12	
	0.8 / 3		
	A3 / V-0		



30 / 5

Rated connection	Additional connection
0.5...4 / 1.5...4	
0.5...4 / 0.5...2.5	
0.4...0.6 (M 2.5)	
7 / 3.5 x 0.6	

Socket StB 8.5 in upper busbar (with test plug PS 2.3) see accessories W-Series

Type	Qty.	Order No.
DLI 2.5 DB	100	1783820000

The rated voltage is reduced to 30 V ac if a pole is bypassed (different potential).

Rated connection	Additional connection
0.5...4 / 1.5...4	
0.5...4 / 0.5...2.5	
0.4...0.6 (M 2.5)	
7 / 3.5 x 0.6	

Type	Qty.	Order No.
DLI 2.5/LD-RT/PNP +- DB	100	1783980000
DLI 2.5/LD-GN/PNP +- DB	100	1783970000

Rated connection	Additional connection
0.5...4 / 1.5...4	
0.5...4 / 0.5...2.5	
0.4...0.6 (M 2.5)	
7 / 3.5 x 0.6	

Type	Qty.	Order No.
DLI 2.5/LD-RT/NPN +- DB	100	1783950000
DLI 2.5/LD-GN/NPN +- DB	100	1783940000

Type	Current [A]	Qty.	Qty.
Current [A]			
Q 2 DLI	20	50	1312500000
Q 3 DLI	20	50	1312600000
Q 4 DLI	20	50	1312700000
Q 4 DLI	20	50	1312700000

Type	Width [mm]	Qty.	Qty.
Width [mm]			
AP DLI2.5 DB	1.5	20	1783550000
EW 35	8.5	50	0383560000

Type	Qty.	Qty.
SD 0.6X3.5X100	10	9008330000

DEK 6

Partition disc TSCH 1 Order No. 0319160000 (Qty. 100)

Type	Current [A]	Qty.	Qty.
Current [A]			
Q 2 DLI	20	50	1312500000
Q 3 DLI	20	50	1312600000
Q 4 DLI	20	50	1312700000
Q 4 DLI	20	50	1312700000

Type	Width [mm]	Qty.	Qty.
Width [mm]			
AP DLI2.5 DB	1.5	20	1783550000
EW 35	8.5	50	0383560000

Type	Qty.	Qty.
SD 0.6X3.5X100	10	9008330000

DEK 6

Partition disc TSCH 1 Order No. 0319160000 (Qty. 100)

Type	Current [A]	Qty.	Qty.
Current [A]			
Q 2 DLI	20	50	1312500000
Q 3 DLI	20	50	1312600000
Q 4 DLI	20	50	1312700000
Q 4 DLI	20	50	1312700000

Type	Width [mm]	Qty.	Qty.
Width [mm]			
AP DLI2.5 DB	1.5	20	1783550000
EW 35	8.5	50	0383560000

Type	Qty.	Qty.
SD 0.6X3.5X100	10	9008330000

DEK 6

Partition disc TSCH 1 Order No. 0319160000 (Qty. 100)

Articles with coloured order number are kept permanently in stock at the central warehouse in Germany. Delivery times see page X.2

Initiator and actuator terminals

Initiator and actuator terminals

Three terminals in one! Weidmüller's cost effective initiator and actuator terminals.

When using ATEX certified components in hazardous area applications the installation instructions and the rated data for accessories in the technical appendix must be considered.

Width/Length/Height with TS35x7.5	mm
Max. current / max. cond. cross-section	A/mm ²
Max. clamping range	mm ²

Technical data

Rated data	
Rated voltage	V
Rated current	A
Rated cross-section	mm ²
Rated impulse voltage / Pollution severity	kV/-
Plug gauge IEC 60-947-1 / flammability class acc. UL94	
Approvals	

Electronic fixtures

Diode current / diode voltage	V / A
LED-voltage, LED-current, polarity	V / mA / -
Resistance	-/V

Clampable conductors (H05V/H07V)

Solid / stranded	mm ²
Flexible / flexible w. wire end ferrule	mm ²
Tightening torque range (clamping screw)	Nm
Stripping length / blade size	mm / -

Information

Ordering data

Version	
Design of terminal	dark beige Wemid
see circuit diagram above	green Wemid
	Dark beige Wemid (LED red)
	Dark beige Wemid (LED green)

Information

Accessories

Cross-connection, pluggable

	(ZQV 2.5N/4)	2-pole	
		3-pole	
		4-pole	
		10-pole	
		50-pole	

Cross-connection, screwable

	WQV 2.5-3	2-pole	
		3-pole	
		4-pole	
		10-pole	

End plate / partition

	dark beige Wemid
--	------------------

End bracket

	dark beige / beige
--	--------------------

Screwdriver

	w. cutting device "swifty set"
	Standard version

Reducing sleeves

	for conductors < 0.5mm ² / AWG 20
	for conductors < 1.0mm ² / AWG 18

Marking systems (see large assortment in chapter M)

	Tags
--	------

For detailed information on additional accessories and usage instructions see chapter accessories.

DLA 2.5

2.5 mm²

Actuator-connection (signal,-,PE)

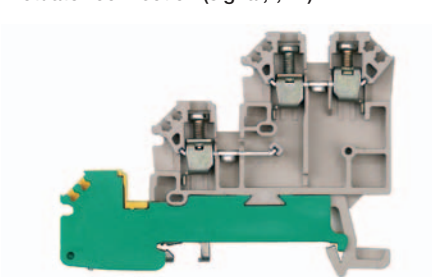

6.1 x 65 x 49
26 / 4
0.13 ... 4

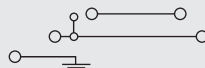

IEC 60947-7-1 (-7-2)

IEC	UL	CSA	EN 50019
250	300	300	
17.5	10	10	
2.5	AWG 22 ...12	AWG 26...12	
		4 / 3	
		A3 / V-0	



Rated connection

0.5...4 / 1.5...4

0.5...4 / 0.5...2.5

0.4...0.6 (M 2.5)

7 / 3.5 x 0.6

If the cross-connection is used to bypass a pole (different potential) or if it is lead via the PE connection, the voltage is reduced to 30 V ac.

Type	Qty.	Order No.
DLA 2.5 DB	100	1783560000

Type	Current [A]	Qty.	Qty.

Current [A]			
Q 2 DLI	20	50	1312500000
Q 3 DLI	20	50	1312600000
Q 4 DLI	20	50	1312700000
Q 4 DLI	20	50	1312700000

Width [mm]

AP DLI2.5 DB	1.5	20	1783550000
--------------	-----	----	------------

Width [mm]

EW 35	8.5	50	0383560000
-------	-----	----	------------

SD 0.6X3.5X100		10	9008330000
----------------	--	----	------------

DEK 6			
-------	--	--	--

Partition disc TSCH 1 Order No. 0319160000 (Qty. 100)

DLA 2.5/D

2.5 mm²

Actuator-connection (circuit with diode)

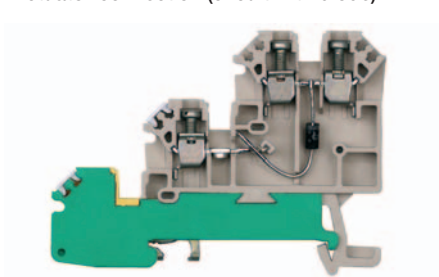

6.1 x 65 x 49
17.5 / 4
0.13 ... 4

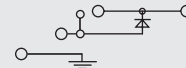

IEC 60947-7-1 (-7-2)

IEC	UL	CSA	EN 50019
250	300	300	
17.5	10	10	
2.5	AWG 22 ...12	AWG 26...12	
		4 / 3	
		A3 / V-0	



1000 / 1

/ 1000

Rated connection

0.5...4 / 1.5...4

0.5...4 / 0.5...2.5

0.4...0.6 (M 2.5)

7 / 3.5 x 0.6

If the cross-connection is used to bypass a pole (different potential) or if it is lead via the PE connection, the voltage is reduced to 30 V ac.

Type	Qty.	Order No.
DLA 2.5/D DB	100	1783590000

Type	Current [A]	Qty.	Qty.

Current [A]			
Q 2 DLI	20	50	1312500000
Q 3 DLI	20	50	1312600000
Q 4 DLI	20	50	1312700000
Q 4 DLI	20	50	1312700000

Width [mm]

AP DLI2.5 DB	1.5	20	1783550000
--------------	-----	----	------------

Width [mm]

EW 35	8.5	50	0383560000
-------	-----	----	------------

SD 0.6X3.5X100		10	9008330000
----------------	--	----	------------

DEK 6			
-------	--	--	--

Partition disc TSCH 1 Order No. 0319160000 (Qty. 100)

Initiator and actuator terminals

DLA 2.5/LD

2.5 mm²

Actuator-connection with LED

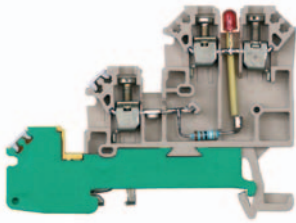

6.1 x 65 x 49
17.5 / 4
0.13 ... 4



IEC 60947-7-1 (-7-2)

IEC	UL	CSA	EN 50019
30	30	30	
17.5	10	10	
2.5	AWG 22 ...12	AWG 26...12	
	0.8 / 3		
	A3 / V-0		



30 / 5

Rated connection
0.5...4 / 1.5...4
0.5...4 / 0.5...2.5
0.4...0.6 (M 2.5)
7 / 3.5 x 0.6

Additional connection

DLA 2.5/LD/D

2.5 mm²

Actuator-connection with LED

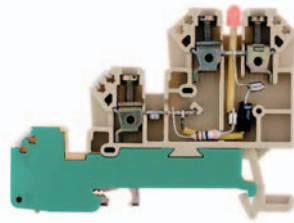

6.1 x 65 x 49
17.5 / 4
0.13 ... 4



IEC 60947-7-1 (-7-2)

IEC	UL	CSA	EN 50019
30	30	30	
17.5	10	10	
2.5	AWG 22 ...12	AWG 26...12	
	0.8 / 3		
	A3 / V-0		



1000 / 1

30 / 5

/ 1000

Rated connection
0.5...4 / 1.5...4
0.5...4 / 0.5...2.5
0.4...0.6 (M 2.5)
7 / 3.5 x 0.6

Additional connection

Type	Qty.	Order No.
DLA 2.5/LD-RT DB	100	1783600000
DLA 2.5/LD-GN DB	100	1783610000

Type	Qty.	Order No.
DLA 2.5/LD-RT/D DB	100	1783620000
DLA 2.5/LD-GN/D DB	100	1783630000

Type	Current [A]	Qty.	Qty.

Current [A]			
Q 2 DLI	20	50	1312500000
Q 3 DLI	20	50	1312600000
Q 4 DLI	20	50	1312700000
Q 4 DLI	20	50	1312700000

Width [mm]			
AP DLI2.5 DB	1.5	20	1783550000

Width [mm]			
EW 35	8.5	50	0383560000

SD 0.6X3.5X100		10	9008330000
----------------	--	----	------------

DEK 6

Partition disc TSCH 1 Order No. 0319160000 (Qty. 100)

Type	Current [A]	Qty.	Qty.

Current [A]			
Q 2 DLI	20	50	1312500000
Q 3 DLI	20	50	1312600000
Q 4 DLI	20	50	1312700000
Q 4 DLI	20	50	1312700000

Width [mm]			
AP DLI2.5 DB	1.5	20	1783550000

Width [mm]			
EW 35	8.5	50	0383560000

SD 0.6X3.5X100		10	9008330000
----------------	--	----	------------

DEK 6

Partition disc TSCH 1 Order No. 0319160000 (Qty. 100)

Articles with coloured order number are kept permanently in stock at the central warehouse in Germany.
Delivery times see page X.2

Mini terminals TS 15

AKZ TS15

When using ATEX certified components in hazardous area applications the installation instructions and the rated data for accessories in the technical appendix must be considered.

Width/Length/Height with TS15x5.5	mm
Max. current / max. cond. cross-section	A/mm ²
Max. clamping range	mm ²

Technical data

Rated data	
Rated voltage (PE: for adjacent terminal)	V
Rated current	A
Rated cross-section	mm ²
Rated impulse voltage / Pollution severity	kV/-
Plug gauge IEC 60-947-1 / flammability class acc. UL94	
Approvals	

Clampable conductors (H05V/H07V)	
Solid / stranded	mm ²
Flexible / flexible w. wire end ferrule	mm ²
Tightening torque range (clamping screw)	Nm
Stripping length / blade size	mm / -

2 clampable conductors of equal cross-section	
Solid / stranded	mm ²
Flexible / flexible w. wire end ferrule	mm ²

Information

Ordering data

Version	
dark beige Wemid (PA)	
blue Wemid (PA)	
green/yellow Wemid (PA)	

Information

Accessories

Cross-connection, pluggable	
	ZQV 2.5N/4
	2-pole
	3-pole
	4-pole
	10-pole
	41-/50-pole

Cross-connection, screwable	
	Q3
	2-pole
	3-pole
	4-pole
	10-pole

End plate / partition	
End plate	dark beige Wemid
	blue Wemid
Partition	dark beige Wemid
	blue Wemid

End bracket	
	dark beige

Testing	
	Socket
	Test plug

Marking systems (see assortment in chapter M)	
	Tags

For detailed information on additional accessories and usage instructions see chapter accessories.

AKZ 1.5

1.5 mm²

Feed-through terminal (V2)

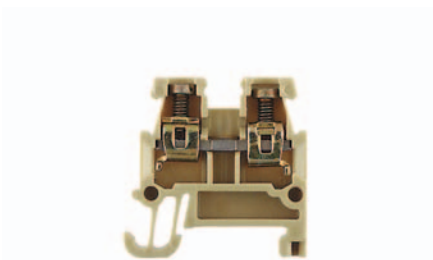

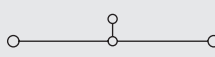
5.1 x 24.8 x 25	
24 / 2.5	
0.21 ... 2.5	

IEC 60947-7-1		EEx e II T II 2 G D	
IEC	UL	CSA	EN 50019
250	150	300	175
17.5	15	10	10
1.5	AWG 22 ...14	AWG 24...16	1.5
		4 / 3	
		A1 / V2	

 SIRAS 02ATEX3001 U

Rated connection	
0.5...2.5 / 1.5...1.5	
0.5...1.5 / 0.5...1.5	
0.4...0.6 (M 2.5)	
7 / 3.0 x 0.5	

0.5...1	
0.5...1 / 0.5...0.75	

Information

Type	Qty.	Order No.
AKZ 1.5	100	0340460000
AKZ 1.5 BL	100	0340480000

Information

Type	Current [A]	Qty.	Order No.

Current [A]			
Q 2 AKZ1.5	24	50	0368200000
Q 3 AKZ1.5	24	50	0368300000
Q 4 AKZ1.5	24	50	0368400000
Q 4 AKZ1.5	24	50	0368400000

Width [mm]			
AP AKZ1.5	1.5	50	0340560000
AP AKZ1.5 BL	1.5	50	0340580000

Width [mm]			
EW 15	9.5	50	0382860000

STB 8.5/D4/2.3/M2.5 AKZ	50	0215700000
PS 2.3 RT	20	0180400000

DEK 5		
-------	--	--

AKZ 2.5

2.5 mm²

Feed-through terminal (V2)

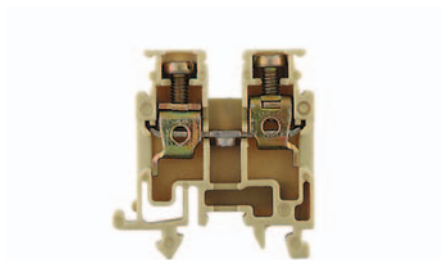

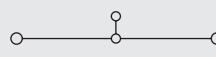
5.1 x 25.5 x 26.5	
32 / 4	
0.13 ... 4	

IEC 60947-7-1		EEx e II T II 2 G D	
IEC	UL	CSA	EN 50019
250	300	300	175
24	10	10	15
2.5	AWG 22 ...12	AWG 26...12	2.5
		4 / 3	
		A3 / V2	

 SIRAS 02ATEX3001 U

Rated connection	
0.5...4 / 1.5...2.5	
0.5...2.5 / 0.5...2.5	
0.4...0.6 (M 2.5)	
7 / 3.0 x 0.5	

0.5...1.5	
0.5...1.5 / 0.5...1.5	

Information

Type	Qty.	Order No.
AKZ 2.5	100	697160000
AKZ 2.5 BL	100	697180000

Information

Type	Current [A]	Qty.	Order No.

Current [A]			
Q 2 AKZ1.5	24	50	0368200000
Q 3 AKZ1.5	24	50	0368300000
Q 4 AKZ1.5	24	50	0368400000
Q 4 AKZ1.5	24	50	0368400000

Width [mm]			
AP AKZ2.5	2.5	50	0697360000
AP AKZ2.5 BL	2.5	50	0697380000
TW AKZ 2.5	0.5	20	0318560000
TW AKZ2.5 BL	0.5	20	0318580000

Width [mm]			
EW 15	9.5	50	0382860000

STB 8.5/D4/2.3/M2.5 AKZ	50	0215700000
PS 2.3 RT	20	0180400000

DEK 5		
-------	--	--

Mini terminals TS 15

AKZ 4

4 mm²

Feed-through terminal (V2)

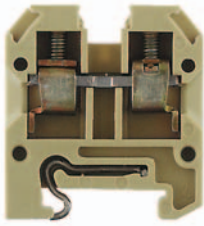

6.1 x 27 x 30.5
41 / 6
0.13 ... 6

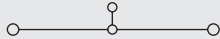

IEC 60947-7-1

EEx e II

IEC	UL	CSA	EN 50019
400	300	300	275
32	27	10	21
4	AWG 22 ...12	AWG 24...12	4
6 / 3			
A3 / V2			

SIRI 02ATEX3001 U

Rated connection

0.5...6 / 1.5...4
0.5...4 / 0.5...4
0.5...1.0 (M3)
8 / 3.5 x 0.6

0.5...1.5
0.5...1.5 / 0.5...1.5

2 conductors 1.5mm² solid have to be connected at 0.6 Nm.

Type	Qty.	Order No.
AKZ 4	100	294360000
AKZ 4 BL	100	294380000

Type	Current [A]	Qty.	Order No.

Current [A]			
Q 2 AKZ4	24	50	033640000
Q 3 AKZ4	24	50	033650000
Q 4 AKZ4	24	50	033660000
Q 4 AKZ4	24	50	033660000

Width [mm]			
AP AKZ4	1.5	20	0294460000
AP AKZ4 BL	1.5	20	0294480000
TW AKZ4	0.5	50	0348260000

Width [mm]			
EW 15	9.5	50	0382860000

STB 8.5/D4/2.3/M2.5 AKZ	50	0215700000
PS 2.3 RT	20	0180400000

DEK 6

AKE 2.5

2.5 mm²

Fuse terminal (V2)

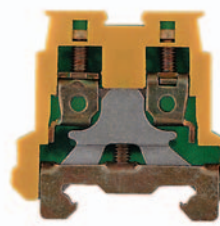

5.1 x 28 x 28
/ 4
0.13 ... 4

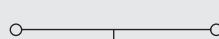

IEC 60947-7-2

EEx e II

IEC	UL	CSA	EN 50019
2.5	AWG 22 ...12	AWG 26...12	2.5
/ 3			
A3 / V2			

SIRI 02ATEX3001 U

Rated connection

0.5...4 / 1.5...2.5
0.5...2.5 / 0.5...2.5
0.4...0.6 (M 2.5)
7 / 3.0 x 0.5

0.5...1.5
0.5...1.5 / 0.5...1.5

Type	Qty.	Order No.
AKE 2.5	100	1303360000

Type	Current [A]	Qty.	Order No.

Current [A]			

Width [mm]			

Width [mm]			
EW 15	9.5	50	0382860000

DEK 5

AKE 4

4 mm²

Fuse terminal (V2)



7 x 32 x 34.5
/ 6
0.13 ... 6

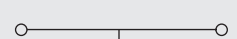

IEC 60947-7-2

EEx e II

IEC	UL	CSA	EN 50019
4	AWG 22 ...12	AWG 26...12	4
/ 3			
A3 / V2			

SIRI 02ATEX3001 U

Rated connection

0.5...6 / 1.5...4
0.5...4 / 0.5...2.5
0.5...1.0 (M3)
9 / 3.5 x 0.6

0.5...1.5
0.5...1.5 / 0.5...1.5

Type	Qty.	Order No.
AKE 4	100	0380260000

Type	Current [A]	Qty.	Order No.

Current [A]			

Width [mm]			

Width [mm]			
EW 15	9.5	50	0382860000

DEK 6,5

Mini terminals TS 15

W-Series TS 15

When using ATEX certified components in hazardous area applications the installation instructions and the rated data for accessories in the technical appendix must be considered.

Width/Length/Height with TS15x5.5	mm
Max. current / max. cond. cross-section	A/mm ²
Max. clamping range	mm ²

Technical data

Rated data	
Rated voltage (PE: for adjacent terminal)	V
Rated current	A
Rated cross-section	mm ²
Rated impulse voltage / Pollution severity	kV/-
Plug gauge IEC 60-947-1 / flammability class acc. UL94	
Approvals	

Clampable conductors (H05V/H07V)	
Solid / stranded	mm ²
Flexible / flexible w. wire end ferrule	mm ²
Tightening torque range (clamping screw)	Nm
Stripping length / blade size	mm / -

2 clampable conductors of equal cross-section	
Solid / stranded	mm ²
Flexible / flexible w. wire end ferrule	mm ²

Information
PZ 6/5 recommended as crimping tool for 1,5mm ² with wire end ferrule

Ordering data

Version	Type	Qty.	Order No.
dark beige Wemid (PA)	WDU 1.5/R3.5	100	1753280000
blue Wemid (PA)	WDU 1.5/R3.5 BL	100	1754170000
green/yellow Wemid (PA)			

Information

Accessories

Cross-connection, pluggable	
	ZQV 2.5N/4
	2-pole
	3-pole
	4-pole
	10-pole
	41-/50-pole

Cross-connection, screwable	
	Q3
	2-pole
	3-pole
	4-pole
	10-pole

End plate / partition	
End plate	dark beige Wemid
	blue Wemid
Partition	dark beige Wemid
	blue Wemid

End bracket	
	dark beige

Testing	
	Socket
	Test plug

Marking systems (see assortment in chapter M)	
	Tags

For detailed information on additional accessories and usage instructions see chapter accessories.

WDU 1.5/R 3.5

1.5 mm²

Feed-through terminal (V0)

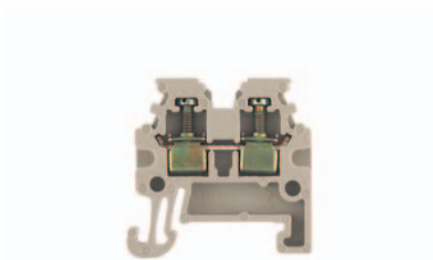

3.5 x 24.5 x 25
17.5 / 1.5
0.13 ... 1.5

IEC 60947-7-1 EEx e II Ex T II 2 G D

IEC	UL	CSA	EN 50019
400	300	300	275
17.5	10	10	14
1.5	AWG 26 ...14	AWG 26...16	1.5
4 / 3			
A1 / V-0			

Rated connection	
0.5...1.5 / 1.5...1.5	
0.5...1.5 / 0.5...1.5	
0.3 (M2)	
7 / 0.4 x 2.5	

0.5...0.75
0.5...0.75 / 0.5...0.5

Information
PZ 6/5 recommended as crimping tool for 1,5mm ² with wire end ferrule

Type	Qty.	Order No.
WDU 1.5/R3.5	100	1753280000
WDU 1.5/R3.5 BL	100	1754170000

Information

Type	Current [A]	Qty.	Order No.
ZQV 1.5/2	17.5	60	1776120000
ZQV 1.5/3	17.5	60	1776130000
ZQV 1.5/4	17.5	60	1776140000
ZQV 1.5/10	17.5	20	1776200000

Current [A]	

Width [mm]	
WAP WDU1.5/R3.5	1.5 20 1754190000

Width [mm]	
EW 15	9.5 50 0382860000

Testing	

Marking systems (see assortment in chapter M)	
	Tags

For detailed information on additional accessories and usage instructions see chapter accessories.

WDK 1.5/R3.5

1.5 mm²

Double feed-through terminal (V0)

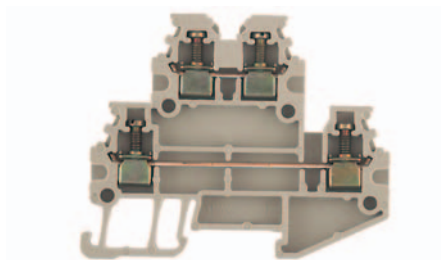

3.5 x 46.5 x 38.5
17.5 / 1.5
0.13 ... 1.5

IEC 60947-7-1 EEx e II Ex T II 2 G D

IEC	UL	CSA	EN 50019
400	300	300	275
16	10	10	15
1.5	AWG 26 ...14	AWG 26...16	1.5
4 / 3			
A1 / V-0			

Rated connection	
0.5...1.5 / 1.5...1.5	
0.5...1.5 / 0.5...1.5	
0.3 (M2)	
7 / 0.4 x 2.5	

0.5...0.75
0.5...0.75 / 0.5...0.5

Information
PZ 6/5 recommended as crimping tool for 1,5mm ² with wire end ferrule

Type	Qty.	Order No.
WDK 1.5/R3.5	100	1753290000
WDK 1.5/R3.5 BL	100	1754180000

Information

Type	Current [A]	Qty.	Order No.
ZQV 1.5/2	17.5	60	1776120000
ZQV 1.5/3	17.5	60	1776130000
ZQV 1.5/4	17.5	60	1776140000
ZQV 1.5/10	17.5	20	1776200000

Current [A]	

Width [mm]	
WAP WDK1.5/R3.5	1.5 20 1754200000

Width [mm]	
EW 15	9.5 50 0382860000

Testing	

Marking systems (see assortment in chapter M)	
	Tags

For detailed information on additional accessories and usage instructions see chapter accessories.

Mini terminals TS 15

WPE 1.5/R3.5

1.5 mm²

PE terminal (V0)

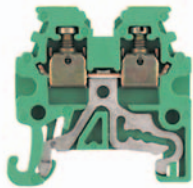

3.5 x 24.5 x 25

/ 1.5

0.13 ... 1.5

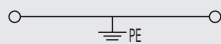

IEC 60947-7-2

IEC	UL	CSA	EN 50019
-----	----	-----	----------

1.5	AWG 26 ...18	AWG 26...18
-----	--------------	-------------

4 / 3

A1 / V-0



Rated connection

0.5...1.5 / 1.5...1.5

0.5...1.5 / 0.5...1.5

0.3 (M2)

7 / 0.4 x 2.5

0.5...0.75

0.5...0.75 / 0.5...0.5

PZ 6/5 recommended as crimping tool for 1,5mm² with wire end ferrule

Type	Qty.	Order No.
WPE 1.5/R3.5	100	1798460000

Type	Current [A]	Qty.	Order No.
Current [A]			
Width [mm]			
WAP WDU1.5/R3.5	1.5	20	1754190000
Width [mm]			
EW 15	9.5	50	0382860000

DEK 5/3,5

Articles with coloured order number are kept permanently in stock at the central warehouse in Germany. Delivery times see page X.2

Terminals with spring loaded cable clamps

Terminal with external springing

Spring below screw clamp provides additional contact safety.

When using ATEX certified components in hazardous area applications the installation instructions and the rated data for accessories in the technical appendix must be considered.

Width/Length/Height with TS35x7.5	mm
Max. current / max. cond. cross-section	A/mm ²
Max. clamping range	mm ²

Technical data

Rated data	
Rated voltage	V
Rated current	A
Rated cross-section	mm ²
Rated impulse voltage / Pollution severity	kV/-
Plug gauge IEC 60-947-1 / flammability class acc. UL94	
Approvals	

Clampable conductors (H05V/H07V)

Solid / stranded	mm ²
Flexible / flexible w. wire end ferrule	mm ²
Tightening torque range (clamping screw)	Nm
Stripping length / blade size	mm / -

2 clampable conductors of equal cross-section

Solid / stranded	mm ²
Flexible / flexible w. wire end ferrule	mm ²

Information

Ordering data

Version	
	dark beige Wernid
(Combi-connection TS32/35)	dark beige Wernid
(Combi-connection TS32/35)	black PA

Information

Accessories

Cross-connection, pluggable



ZQV 2.5N/4

Cross-connection, screwable



WQV 2.5-3

End plate / partition

End plate	dark beige Wernid
	black wernid
Partition	dark beige Wernid

End bracket

dark beige

Testing

Test adapter

Marking systems (see large assortment in chapter M)

Tags

For detailed information on additional accessories and usage instructions see chapter accessories.

WDU 4 SL

4 mm²

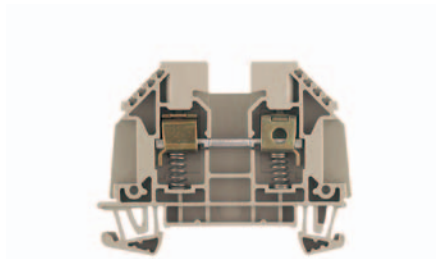

6.1 x 60 x 47

41 / 6

0.33 ... 6

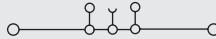

IEC 60947-7-1

EEx e II

IEC	UL	CSA	EN 50019
500	600	300	275
32	30	25	28
4	AWG 22 ...10	AWG 22...10	4
6 / 3			
A4 / V-0			



SIRA 02ATEX3242 U

Rated connection

0.5...6 / 1.5...6
0.5...4 / 0.5...4
0.5...1.0 (M 3)
15 / 3.5 x 0.6

Mind the max. current of the terminal (41A) when using the cross-connection!

Type	Qty.	Order No.
WDU 4 SL	50	9537440000
WDU 4 SL/EN	50	9537450000
WDU 4 SL/EN SW	50	9537510000

Hook-shaped cable lug acc. to ESI SO-18 part 2 size 2 (3mm) 2 pieces 0.28...1.5mm²

Type	Current [A]	Qty.	Order No.
ZQV 4N/2	32	60	1758250000
ZQV 4N/3	32	60	1762630000
ZQV 4N/4	32	60	1762620000
ZQV 4N/10	32	20	1758260000
ZQV 4N/41	32	10	1758270000

Type	Current [A]	Qty.	Order No.
WQV 4/2	41	50	1051960000
WQV 4/3	41	50	1054560000
WQV 4/4	41	50	1054660000
WQV 4/10	41	20	1052060000

Type	Width [mm]	Qty.	Order No.
WAP 2.5-10	1.5	50	1050000000
WAP 2.5-10 SW	1.5	50	1050010000
WAP 16+35 WTW 2.5-10	1.5	20	1050100000

Type	Width [mm]	Qty.	Order No.
WEW-35/2	8	100	1061200000

Type	Qty.	Order No.
WTA 3 WDU4	25	1632350000

WS 12/6 / DEK 5

Hook-shaped cable lug 0.25-1.5mm² (black) order no. 9036290000 (Qty 100)

WDU 6 SL

6 mm²



7.9 x 60 x 47

57 / 10

0.5 ... 10

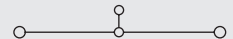

IEC 60947-7-1

EEx e II

IEC	UL	CSA	EN 50019
500	150	300	275
41	45	45	36
6	AWG 20 ...8	AWG 20...8	6
6 / 3			
A5 / V-0			



SIRA 02ATEX3242 U

Rated connection

0.5...10 / 1.5...10
0.5...6 / 0.5...6
0.8...1.4 (M 3.5)
16 / 4.0 x 0.8

1.5...2.5
1.5...2.5 / 0.5...2.5

Rated data ESI: 500V/24A / Mind the max. current of the terminal (57A) when using the cross-connection!

Type	Qty.	Order No.
WDU 6 SL	50	9537460000
WDU 6 SL/EN	50	9537470000
WDU 6 SL/EN SW	50	9537430000

Hook-shaped cable lug acc. to ESI SO-18 part 2 size 1 (3mm) and size 2 (4.6mm) 0.28...1.5/1...2.5mm²

Type	Current [A]	Qty.	Order No.
WQV 6/2	57	50	1052360000
WQV 6/3	57	50	1054760000
WQV 6/4	57	50	1054860000
WQV 6/10	57	20	1052260000

Type	Current [A]	Qty.	Order No.
WAP 2.5-10	1.5	50	1050000000
WAP 2.5-10 SW	1.5	50	1050010000
WAP 16+35 WTW 2.5-10	1.5	20	1050100000

Type	Width [mm]	Qty.	Order No.
WEW-35/2	8	100	1061200000

Type	Qty.	Order No.
WTA 5/1	25	1051260000

WS 12/6,5 / DEK 8

Hook-shaped cable lug 0.25-1.5mm² (black) order no. 9036290000 (Qty 100) / 1.25-2.5mm² (black) order no. 9036300000 (Qty 100)

Terminals with spring loaded cable clamps

WDU 10 SL

10 mm²

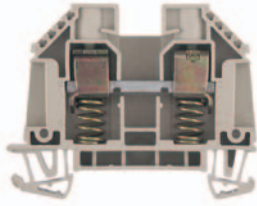

9.9 x 60 x 47
76 / 16
1.31 ... 16

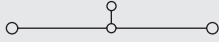

IEC 60947-7-1

EEx e II

IEC	UL	CSA	EN 50019
500	150	300	275
57	50	65	50
10	AWG 16 ...8	AWG 16...8	10
6 / 3			
A6 / V-0			



SIRA 02ATEX3242 U

Rated connection

1.5...16 / 1.5...16
1.5...10 / 1.5...10
1.2...2.4 (M 4)
17 / 5.5 x 1.0

2.5...4
2.5...4 / 1...6

Rated data ESI: 500V/36A / 16mm² stranded must be connected at 2 Nm.

Type	Qty.	Order No.
WDU 10 SL	50	9537480000
WDU 10 SL/EN	50	9537490000
WDU 10 SL/EN SW	50	9537410000

Hook-shaped cable lug acc. to ESI SO-18 part 2 size 1 (3mm) and size 2 (4.6mm) 0.28...1.5/1...2.5mm²

Type	Current [A]	Qty.	Order No.
WQV 10/2	76	50	1052560000
WQV 10/3	63	50	1054960000
WQV 10/4	63	50	1055060000
WQV 10/10	63	20	1052460000

Type	Width [mm]	Qty.	Order No.
WAP 2.5-10	1.5	50	1050000000
WAP 2.5-10 SW	1.5	50	1050010000
WTW EN	1.5	20	1058800000

Type	Width [mm]	Qty.	Order No.
WEW-35/2	8	100	1061200000

Type	Qty.	Order No.
WTA 5/1	25	1051260000

WS 12/6,5 / DEK 5

Hook-shaped cable lug 0.25-1.5mm² (black) order no. 9036290000 (Qty. 100) / 1.25-2.5mm² (black) order no. 9036300000 (Qty 100)

WTR 4 SL

4 mm²

With clamping screw

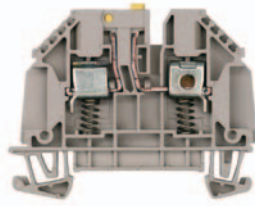

6.1 x 61.2 x 48.6
32 / 6
0.33 ... 6



IEC 60947-7-1 / VDE 0100-537

IEC	UL	CSA	EN 50019
500	300	300	
32	22	24	
4	AWG 22 ...10	AWG 22...10	4
6 / 3			
A4 / V-0			



Rated connection

0.5...6 / 1.5...6
0.5...4 / 0.5...4
0.5...1.0 (M 3)
13 / 3.5 x 0.6

0.5...1.5
0.5...1.5 / 0.5...1.5

UL/CSA 600V possible with end plate WAP or partition plate WTW.

Type	Qty.	Order No.
WTR 4 SL	50	7910270000
WTR 4 SL/EN	50	7910360000
WTR 4 SL/EN SW	50	7910380000

Hook-shaped cable lug acc. to ESI SO-18 part 2 size 2 (3mm) 2 pieces 0.28...1.5mm²

Type	Current [A]	Qty.	Order No.
ZQV 4N/2	32	60	1758250000
ZQV 4N/3	32	60	1762630000
ZQV 4N/4	32	60	1762620000
ZQV 4N/10	32	20	1758260000
ZQV 4N/41	32	10	1758270000

Type	Width [mm]	Qty.	Order No.
WAP 2.5-10	1.5	50	1050000000
WAP 2.5-10 SW	1.5	50	1050010000
WAP 16+35 WTW 2.5-10	1.5	20	1050100000

Type	Width [mm]	Qty.	Order No.
WEW-35/2	8	100	1061200000

WS 12/6 / DEK 6

Hook-shaped cable lug 0.25-1.5mm² (black) order no. 9036290000 (Qty. 100)

WTR 4 SL STB

4 mm²

With socket

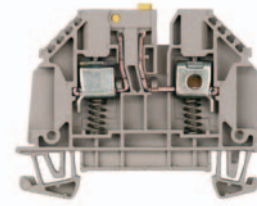

6.1 x 61.2 x 48.6
32 / 6
0.33 ... 6

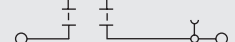

IEC 60947-7-1 / VDE 0100-537

IEC	UL	CSA	EN 50019
500	300	300	
32	22	24	
4	AWG 22 ...10	AWG 22...10	4
6 / 3			
A4 / V-0			



Rated connection

0.5...6 / 1.5...6
0.5...4 / 0.5...4
0.5...1.0 (M 3)
13 / 3.5 x 0.6

0.5...1.5
0.5...1.5 / 0.5...1.5

UL/CSA 600V possible with end plate WAP or partition plate WTW.

Type	Qty.	Order No.
WTR 4 STB SL	50	7910300000
WTR 4 STB SL/EN	50	7910390000
WTR 4 STB SL/EN SW	50	7910410000

Hook-shaped cable lug acc. to ESI SO-18 part 2 size 2 (3mm) 2 pieces 0.28...1.5mm²

Type	Current [A]	Qty.	Order No.
ZQV 4N/2	32	60	1758250000
ZQV 4N/3	32	60	1762630000
ZQV 4N/4	32	60	1762620000
ZQV 4N/10	32	20	1758260000
ZQV 4N/41	32	10	1758270000

Type	Width [mm]	Qty.	Order No.
WAP 2.5-10	1.5	50	1050000000
WAP 2.5-10 SW	1.5	50	1050010000
WAP 16+35 WTW 2.5-10	1.5	20	1050100000

Type	Width [mm]	Qty.	Order No.
WEW-35/2	8	100	1061200000

WS 12/6 / DEK 6

Hook-shaped cable lug 0.25-1.5mm² (black) order no. 9036290000 (Qty. 100)

Terminals with spring loaded cable clamps

Terminal with external springing

Spring below screw clamp provides additional contact safety.

When using ATEX certified components in hazardous area applications the installation instructions and the rated data for accessories in the technical appendix must be considered.

Width/Length/Height with TS35x7.5	mm
Max. current / max. cond. cross-section	A/mm ²
Max. clamping range	mm ²

Technical data

Rated data	
Rated voltage	V
Rated current	A
Rated cross-section	mm ²
Rated impulse voltage / Pollution severity	kV/-
Plug gauge IEC 60-947-1 / flammability class acc. UL94	
Approvals	

Clampable conductors (H05V/H07V)

Solid / stranded	mm ²
Flexible / flexible w. wire end ferrule	mm ²
Tightening torque range (clamping screw)	Nm
Stripping length / blade size	mm / -

2 clampable conductors of equal cross-section

Solid / stranded	mm ²
Flexible / flexible w. wire end ferrule	mm ²

Information

Ordering data

Version	
	dark beige Wernid
(Combi-connection TS32/35)	dark beige Wernid
(Combi-connection TS32/35)	black PA
Information	

Accessories

Cross-connection, pluggable



ZQV 2.5N/4

Type	Current [A]	Qty.	Order No.
2-pole	ZQV 4N/2	32 60	1758250000
3-pole	ZQV 4N/3	32 60	1762630000
4-pole	ZQV 4N/4	32 60	1762620000
10-pole	ZQV 4N/10	32 20	1758260000
41/-50-pole	ZQV 4N/41	32 10	1758270000

Cross-connection, screwable



WQV 2.5-3

Type	Current [A]	Qty.	Order No.
2-pole			
3-pole			
4-pole			
10-pole			

End plate / partition

<i>End plate</i>	dark beige Wernid	WAP 2.5-10	1.5	50	1050000000
	black wernid	WAP 2.5-10 SW	1.5	50	1050010000
<i>Partition</i>	dark beige Wernid	WAP 16+35 WTW 2.5-10	1.5	20	1050100000

End bracket

dark beige

Type	Width [mm]	Qty.	Order No.
WEW-35/2	8	100	1061200000

Testing

Test adapter

Marking systems (see large assortment in chapter M)

Tags

WS 12/6 / DEK 6

For detailed information on additional accessories and usage instructions see chapter accessories.

Hook-shaped cable lug 0.25-1.5mm² (black) order no. 9036290000 (Qty. 100)

WTR 4 SI SL

4 mm²

With fuse holder

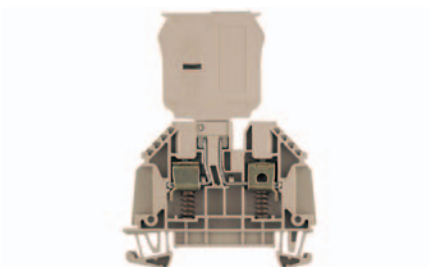

6.1 x 61.2 x 80.5
6.3 / 6
0.33 ... 6

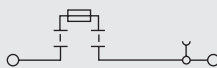

IEC 60947-7-1 / VDE 0100-537

IEC	UL	CSA	EN 50019
400	300	300	
6.3	6.3	6.3	
4	AWG 22 ... 10	AWG 22...10	
		6 / 3	
		A4 / V-0	



Rated connection

0.5...6 / 1.5...6
0.5...4 / 0.5...4
0.5...1.0 (M 3)
13 / 3.5 x 0.6

WTL 6 SL

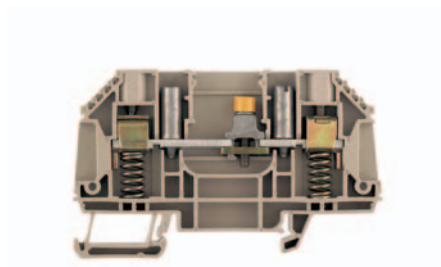
6 mm²

7.9 x 82.7 x 50.4
57 / 10
0.5 ... 10

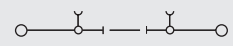

IEC 60947-7-1 / VDE 0100-537

IEC	UL	CSA	EN 50019
500			
41			
6			6
		6 / 3	
		A5 / V-0	



Rated connection

0.5...10 / 1.5...10
0.5...6 / 0.5...6
0.8...1.4 (M 3.5)
16 / 4.0 x 0.8

1.5...2.5
1.5...2.5 / 1.5...2.5

Rated data ESI: 500V/24A. For appropriate accessories see page D.4 WTL 6/1 or section Accessories W-Series

Type	Qty.	Order No.
WTL 6 SL	50	9538070000
WTL 6 SL/EN	50	9538080000
WTL 6 SL/EN SW	50	9538030000
Hook-shaped cable lug acc. to ESI SO-18 part 2 size 1 (3mm) and size 2 (4.6mm) 0.28...1.5/1...2.5mm ²		

Type	Current [A]	Qty.	Order No.

Type	Current [A]	Qty.	Order No.

Type	Width [mm]	Qty.	Order No.

Type	Width [mm]	Qty.	Order No.
WEW-35/2	8	100	1061200000

WS 12/6,5 / DEK 8

Hook-shaped cable lug 0.25-1.5mm² (black) order no. 9036290000 (Qty 100) / 1.25-2.5mm² (black) order no. 9036300000 (Qty. 100)

Terminals with spring loaded cable clamps

WTD 6 SL

6 mm²

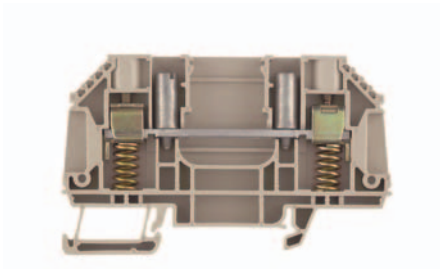

7.9 x 82.7 x 50.4

57 / 10

0.5 ... 10

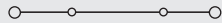

IEC 60947-7-1 / VDE 0100-537

IEC	UL	CSA	EN 50019
500			
41			
6			6
	6 / 3		
	A5 / V-0		



Rated connection

0.5...10 / 1.5...10

0.5...6 / 0.5...6

0.8...1.4 (M 3.5)

16 / 4.0 x 0.8

1.5...2.5

1.5...2.5 / 1.5...2.5

Rated data ESI: 500V/24A. For appropriate accessories see page D.41 WTD 6/1 or section Accessories W-Series

Type	Qty.	Order No.
WTD 6 SL	50	9538090000
WTD 6 SL/EN	50	9538100000
WTD 6 SL/EN SW	50	9538050000

Hook-shaped cable lug acc. to ESI SO-18 part 2 size 1 (3mm) and size 2 (4.6mm) 0.28...1.5/1...2.5mm²

Type	Current [A]	Qty.	Order No.
Current [A]			
Width [mm]			
Width [mm]			
WEW-35/2	8	100	1061200000

WS 12/6,5 / DEK 8

Hook-shaped cable lug 0.25-1.5mm² (black) order no. 9036290000 (Qty 100) / 1.25-2.5mm² (black) order no. 9036300000 (Qty. 100)

Articles with coloured order number are kept permanently in stock at the central warehouse in Germany. Delivery times see page X.2

Terminals for temperature measuring circuits

Thermocouple terminals

WDU 2.5/TC

2.5 mm²

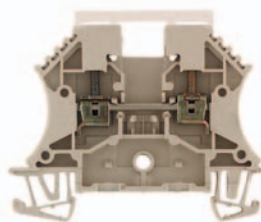

When using ATEX certified components in hazardous area applications the installation instructions and the rated data for accessories in the technical appendix must be considered.

Width/Length/Height with TS35x7.5	mm
Max. current / max. cond. cross-section	A/mm ²
Max. clamping range	mm ²

10.2 x 60 x 50.5
/ 2.5
0.13 ... 2.5

Technical data

Rated data	
Rated voltage	V
Rated current	A
Rated cross-section	mm ²
Rated impulse voltage / Pollution severity	kV/-
Plug gauge IEC 60-947-1 / flammability class acc. UL94	
Approvals	

IEC 60947-7-1 / IEC 60584 EEx e II T II 2 G D

IEC	UL	CSA	EN 50019
			50
			1
2.5			2.5
		/ 3	
		A2 / V-0	

Clampable conductors (H05V/H07V)	
Solid / stranded	mm ²
Flexible / flexible w. wire end ferrule	mm ²
Tightening torque range (clamping screw)	Nm
Stripping length / blade size	mm / -

Rated connection	
0.5...2.5 / 1.5...2.5	
0.5...2.5 / 0.5...2.5	
0.4...0.6 (M 2.5)	
10 / 3.5 x 0.6	

2 clampable conductors of equal cross-section	
Solid / stranded	mm ²
Flexible / flexible w. wire end ferrule	mm ²

0.5...1.5	
0.5...1.5 / 0.5...1.5	

Information

Ordering data

Version			
dark beige Wemid	(NiCr - Ni)	Type K	
	(Cu - CuNi)	Type T	
	(Fe-CuNi)	Type J	
	(Pt 10% - Pt Rh/Pt 13% - Pt Rh)	Type SR	
	(Pt 10% Rh - Pt 6% Rh)	Type B	
	(NiCr - CuNi)	Type E	
	(NiSi - Nicrosil)	Type N	

Type	Qty.	Order No.
WDU 2.5/TC TYP K	50	1024100000
WDU 2.5/TC TYP T	50	1024200000
WDU 2.5/TC TYP J	50	1024300000
WDU 2.5/TC TYP SR	50	1024400000
WDU 2.5/TC TYP B	50	1033700000
WDU 2.5/TC TYP E	50	1033300000
WDU 2.5/TC TYP N	50	1041500000

Information

Accessories

Cross-connection, pluggable	
	2-pole
	3-pole
	4-pole
	10-pole
	41-pole

Cross-connection, screwable	
	2-pole
	3-pole
	4-pole
	10-pole
WQV 2.5-3	

End plate / partition	
End plate	dark beige Wemid
Partition	dark beige Wemid
End bracket	
	dark beige Wemid

Testing	
	Test adapter

Marking systems (see large assortment in chapter M)	
	Tags

For detailed information on additional accessories and usage instructions see chapter accessories.

Type	Current [A]	Qty.	Order No.

Current [A]			

Width [mm]			
WAP 2.5-10	1.5	50	1050000000
WAP 16+35 WTW 2.5-10	1.5	20	1050100000

Width [mm]			

Tags			
WS 12/5 / DEK 5			

Weidmüller thermocouple terminals are specially designed to transmit very small voltages in temperature measuring circuits. Special busbars ensure that no false signals are transmitted in the terminal when temperature differences between the positive and negative paths exist. This high measuring precision is required, for example, in aircraft engine performance test rigs, complicated chemical processes, controllers, etc.

- Busbar material corresponds to thermal and compensating conductors
- Clear thermocouple marking
- 2-pole blocks per thermocouple
- Stacking width 10 mm

Configuration of a temperature measuring circuit

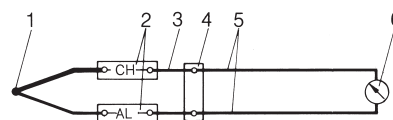

- 1 Thermocouple (sensor)
- 2 Thermocouple terminals
- 3 Compensating conductor
- 4 Reference junction
- 5 Supply conductors (to and from)
- 6 Measuring instrument

The thermocouple terminals shown in this measuring circuit thermoelectrically transmit thermo-electric voltage from the thermocouple to the reference junction and the indicator unit via the compensating conductor. Thermocouple terminals are required for constructing a temperature circuit.

Technical data

Thermocouples acc. to IEC 584 (DIN 43 710)

Busbar	
	Cromel Alumel
	E-Copper Constantan
	Iron Konstantan
	E-Copper/ A-Copper
	S-Copper/ E-Copper
	Cromel- Constantan

Terminals with electronic components

Feed-through terminals

for retrofitting electronic components

WPO 4

4 mm²

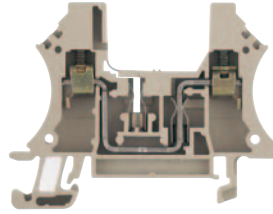

Width/Length/Height with TS35x7.5	mm
Max. current / max. cond. cross-section	A/mm ²
Max. clamping range	mm ²

6.1 x 60 x 47
32 / 4
0.13 ... 4

WPO 4 with fitted varistor

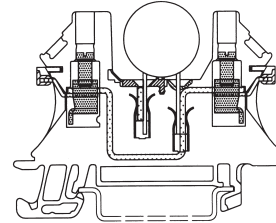

Weidmüller varistor terminals have been designed for retrofitting electronic components, such as varistors, diodes, gas discharge tubes, etc. These electronic terminals no longer have to be configured prior installation to subsequently be delivered with soldered components which can no longer be distinguished.

The significant advantages of this design are:

- **Cost saving**
Components can be changed quickly on site.
Service is limited to visual inspection
- **Clarity:**
Components are easy to distinguish.
- **Flexibility:**
Components can immediately be adapted to changed conditions.

Note:

Never change electronic components in energized systems.

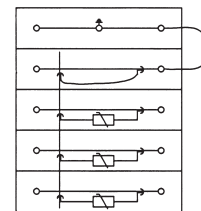

Overvoltage in a three-phase supply discharged to earth via WPE 4 with the aid of varistors and a gas discharge tube.

Technical data

Rated data	
Rated voltage	V
Rated current	A
Rated cross-section	mm ²
Rated impulse voltage / Pollution severity	kV/-
Plug gauge IEC 60-947-1 / flammability class acc. UL94	
Approvals	

IEC 60947-7-1 / IEC 60584

IEC	UL	CSA	EN 50019
250	300	300	
32	10	10	
4	AWG 26...12	AWG 26...12	
		4 / 3	
		A3 / V-0	



Clampable conductors (H05V/H07V)	
Solid / stranded	mm ²
Flexible / flexible w. wire end ferrule	mm ²
Tightening torque range (clamping screw)	Nm
Stripping length / blade size	mm / -

Rated connection	
0.5...4 / 1.5...4	
0.5...4 / 0.5...4	
0.5...1.0 (M 3)	
9 / 3.5 x 0.6	

Ordering data

Version	
dark beige Wemid	

Type	Qty.	Order No.
WPO 4	50	1036000000

Information

Accessories

Intermediate frame	
Thickness 2.5 mm	

Type	Qty.	Order No.
ZR	20	1071100000

Busbar	
---------------	--

Type	Qty.	Order No.
SSch 7.3x1.2	1m	1071200000

Marking systems (see large assortment in chapter M)	
Tags	WS 12/5 / DEK 6

For detailed information on additional accessories and usage instructions see chapter accessories.

Articles with coloured order number are kept permanently in stock at the central warehouse in Germany. Delivery times see page X.2

Terminals with electronic components

Terminals with electronic components

A wide range of terminals with electronic components are available as standard. Customer specific variants available upon request.

When using ATEX certified components in hazardous area applications the installation instructions and the rated data for accessories in the technical appendix must be considered.

Width/Length/Height with TS35x7.5	mm
Max. current / max. cond. cross-section	A/mm ²
Max. clamping range	mm ²

Technical data

Rated data	
Rated voltage	V
Rated current	A
Rated cross-section	mm ²
Rated impulse voltage / Pollution severity	kV/-
Plug gauge IEC 60-947-1 / flammability class acc. UL94	
Approvals	

Electronic fixtures

Diode current / diode voltage	V / A
LED-voltage, LED-current, polarity	V / mA / -
Resistance	-/V

Clampable conductors (H05V/H07V)

Solid / stranded	mm ²
Flexible / flexible w. wire end ferrule	mm ²
Tightening torque range (clamping screw)	Nm
Stripping length / blade size	mm / -

Information

Ordering data

Version	
Design of terminal	dark beige Wemid
see circuit diagram above	green Wemid
	Dark beige Wemid (LED red)
	Dark beige Wemid (LED green)

Information

Accessories

Cross-connection, pluggable

	2-pole
	3-pole
	4-pole
	10-pole
	50-pole

Cross-connection, screwable

	2-pole
	3-pole
	4-pole
	10-pole

End plate / partition

	dark beige Wemid
--	------------------

End bracket

	dark beige / beige
--	--------------------

Screwdriver

	w. cutting device "swifty set"
	Standard version

Reducing sleeves

	for conductors < 0.5mm ² / AWG 20
	for conductors < 1.0mm ² / AWG 18

Marking systems (see large assortment in chapter M)

	Tags
--	------

For detailed information on additional accessories and usage instructions see chapter accessories.

WDK 2.5/D

2.5 mm²

Reverse voltage protection

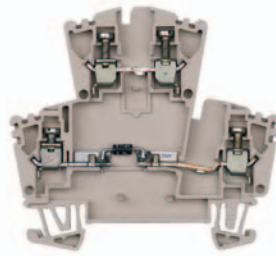

5.1 x 69 x 63

10 / 4

0.13 ... 4

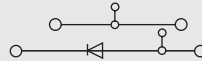

IEC 60947-7-1

IEC	UL	CSA	EN 50019
400			
10			
2.5			
	6 / 3		
	A3 / V-0		



1000 / 1

Rated connection

0.5...4 / 1.5...4

0.5...4 / 0.5...2.5

0.4...0.6 (M 2.5)

10 / 3.5 x 0.6

Rated current 10A for through-going busbars only. Diode 1 N 4007

WDK 2.5/D/1

2.5 mm²

Circuit e. g. for contactor

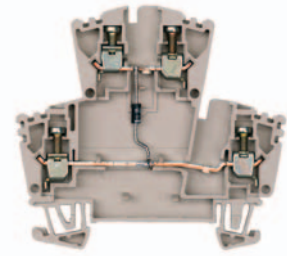

5.1 x 69 x 63

10 / 4

0.13 ... 4

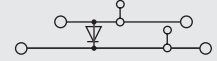

IEC 60947-7-1

IEC	UL	CSA	EN 50019
400			
10			
2.5			
	6 / 3		
	A3 / V-0		



1000 / 1

Rated connection

0.5...4 / 1.5...4

0.5...4 / 0.5...2.5

0.4...0.6 (M 2.5)

10 / 3.5 x 0.6

Rated current 10A for through-going busbars only. Diode 1 N 4007

Type	Qty.	Order No.
WDK 2.5 1D	25	8025610000

Conductor 2.5 mm² with wire end ferrule with plastic collar only with diameter optimised collar (Order No. 1333100000, Qty. 500)

Type	Qty.	Order No.
WDK 2.5 1D A.1	25	1023400000

Conductor 2.5 mm² with wire end ferrule with plastic collar only with diameter optimised collar (Order No. 1333100000, Qty. 500)

Type	Current [A]	Qty.	Qty.
Current [A]			
WQV 2.5/2	32	50	1053660000
WQV 2.5/3	32	50	1053760000
WQV 2.5/4	32	50	1053860000
WQV 2.5/4	32	50	1053860000
Width [mm]			
WAP WDK2.5	1.5	20	1059100000
Width [mm]			
WEW-35/2	8	100	1061200000
Width [mm]			
SD 0.6X3.5X100		10	9008330000
Width [mm]			
WS 8/5 / DEK 5			

Type	Current [A]	Qty.	Qty.
Current [A]			
WQV 2.5/2	32	50	1053660000
WQV 2.5/3	32	50	1053760000
WQV 2.5/4	32	50	1053860000
WQV 2.5/4	32	50	1053860000
Width [mm]			
WAP WDK2.5	1.5	20	1059100000
Width [mm]			
WEW-35/2	8	100	1061200000
Width [mm]			
SD 0.6X3.5X100		10	9008330000
Width [mm]			
WS 8/5 / DEK 5			

Terminals with electronic components

WDK 2.5/D/2

2.5 mm²

Circuit e. g. for contactor

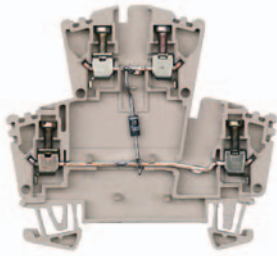

5.1 x 69 x 63
10 / 4
0.13 ... 4



IEC 60947-7-1

IEC	UL	CSA	EN 50019
400			
10			
2.5			
	6 / 3		
	A3 / V-0		
PC			
1000 / 1			

Rated connection	Additional connection
0.5...4 / 1.5...4	
0.5...4 / 0.5...2.5	
0.4...0.6 (M 2.5)	
10 / 3.5 x 0.6	
Rated current 10A for through-going busbars only. Diode 1 N 4007	

Type	Qty.	Order No.
WDK 2.5 1D A.2	25	1023300000
Conductor 2.5 mm ² with wire end ferrule with plastic collar only with diameter optimised collar (Order No. 1333100000, Qty. 500)		

Type	Current [A]	Qty.	Qty.
Current [A]			
WQV 2.5/2	32	50	1053660000
WQV 2.5/3	32	50	1053760000
WQV 2.5/4	32	50	1053860000
WQV 2.5/4	32	50	1053860000
Width [mm]			
WAP WDK2.5	1.5	20	1059100000
Width [mm]			
WEW-35/2	8	100	1061200000
SD 0.6X3.5X100		10	9008330000
WS 8/5 / DEK 5			

WDK 2.5/D/4

2.5 mm²

Lamp test circuit

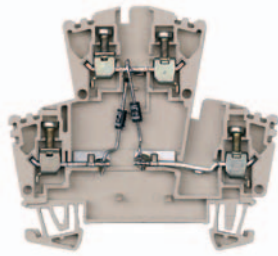

5.1 x 69 x 63
10 / 4
0.13 ... 4

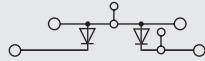

IEC 60947-7-1

IEC	UL	CSA	EN 50019
400			
10			
2.5			
	6 / 3		
	A3 / V-0		
PC			
1000 / 1			

Rated connection	Additional connection
0.5...4 / 1.5...4	
0.5...4 / 0.5...2.5	
0.4...0.6 (M 2.5)	
10 / 3.5 x 0.6	
Rated current 10A for through-going busbars only. Diode 1 N 4007	

Type	Qty.	Order No.
WDK 2.5 2D	25	8014670000
Conductor 2.5 mm ² with wire end ferrule with plastic collar only with diameter optimised collar (Order No. 1333100000, Qty. 500)		

Type	Current [A]	Qty.	Qty.
Current [A]			
WQV 2.5/2	32	50	1053660000
WQV 2.5/3	32	50	1053760000
WQV 2.5/4	32	50	1053860000
WQV 2.5/4	32	50	1053860000
Width [mm]			
WAP WDK2.5	1.5	20	1059100000
Width [mm]			
WEW-35/2	8	100	1061200000
SD 0.6X3.5X100		10	9008330000
WS 8/5 / DEK 5			

WDK 2.5/D/5

2.5 mm²

Lamp test circuit

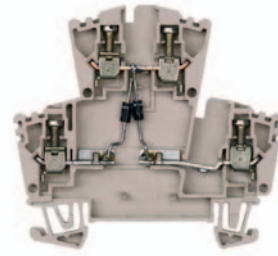

5.1 x 69 x 63
10 / 4
0.13 ... 4

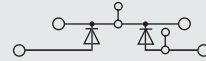

IEC 60947-7-1

IEC	UL	CSA	EN 50019
400			
10			
2.5			
	6 / 3		
	A3 / V-0		
PC			
1000 / 1			

Rated connection	Additional connection
0.5...4 / 1.5...4	
0.5...4 / 0.5...2.5	
0.4...0.6 (M 2.5)	
10 / 3.5 x 0.6	
Rated current 10A for through-going busbars only. Diode 1 N 4007	

Type	Qty.	Order No.
WDK 2.5 2D	25	1022600000
Conductor 2.5 mm ² with wire end ferrule with plastic collar only with diameter optimised collar (Order No. 1333100000, Qty. 500)		

Type	Current [A]	Qty.	Qty.
Current [A]			
WQV 2.5/2	32	50	1053660000
WQV 2.5/3	32	50	1053760000
WQV 2.5/4	32	50	1053860000
WQV 2.5/4	32	50	1053860000
Width [mm]			
WAP WDK2.5	1.5	20	1059100000
Width [mm]			
WEW-35/2	8	100	1061200000
SD 0.6X3.5X100		10	9008330000
WS 8/5 / DEK 5			

Articles with coloured order number are kept permanently in stock at the central warehouse in Germany. Delivery times see page X.2

Terminals with electronic components

Terminals with electronic components

A wide range of terminals with electronic components are available as standard. Customer specific variants available upon request.

When using ATEX certified components in hazardous area applications the installation instructions and the rated data for accessories in the technical appendix must be considered.

Width/Length/Height with TS35x7.5	mm
Max. current / max. cond. cross-section	A/mm ²
Max. clamping range	mm ²

Technical data

Rated data	
Rated voltage	V
Rated current	A
Rated cross-section	mm ²
Rated impulse voltage / Pollution severity	kV/-
Plug gauge IEC 60-947-1 / flammability class acc. UL94	
Approvals	

Electronic fixtures

Diode current / diode voltage	V / A
LED-voltage, LED-current, polarity	V / mA / -
Resistance	-/V

Clampable conductors (H05V/H07V)

Solid / stranded	mm ²
Flexible / flexible w. wire end ferrule	mm ²
Tightening torque range (clamping screw)	Nm
Stripping length / blade size	mm / -

Information

Ordering data

Version	
Design of terminal	dark beige Wemid
see circuit diagram above	green Wemid
	Dark beige Wemid (LED red)
	Dark beige Wemid (LED green)

Information

Accessories

Cross-connection, pluggable	
	2-pole
	3-pole
	4-pole
	10-pole
	50-pole

Cross-connection, screwable	
	2-pole
	3-pole
	4-pole
	10-pole

End plate / partition	dark beige Wemid
------------------------------	------------------

End bracket	dark beige / beige
--------------------	--------------------

Screwdriver	w. cutting device "swifty set" Standard version
--------------------	--

Reducing sleeves	for conductors < 0.5mm ² / AWG 20 for conductors < 1.0mm ² / AWG 18
-------------------------	--

Marking systems (see large assortment in chapter M)	Tags
--	------

For detailed information on additional accessories and usage instructions see chapter accessories.

WDK 2.5/D/6

2.5 mm²

Lamp test circuit

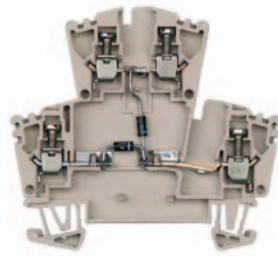

5.1 x 69 x 63

10 / 4

0.13 ... 4



IEC 60947-7-1

IEC	UL	CSA	EN 50019
400			
10			
2.5			
	6 / 3		
	A3 / V-0		



Approvals

1000 / 1

Rated connection

0.5...4 / 1.5...4

0.5...4 / 0.5...2.5

0.4...0.6 (M 2.5)

10 / 3.5 x 0.6

Rated current 10A for through-going busbars only.

WDK 2.5E/o. Electr.

2.5 mm²

For installation of electr. components

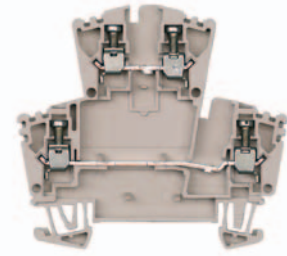

5.1 x 69 x 63

10 / 4

0.13 ... 4

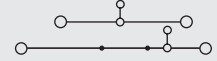

IEC 60947-7-1

IEC	UL	CSA	EN 50019
400			
10			
2.5			
	6 / 3		
	A3 / V-0		



Approvals

1000 / 1

Rated connection

0.5...4 / 1.5...4

0.5...4 / 0.5...2.5

0.4...0.6 (M 2.5)

10 / 3.5 x 0.6

Rated current 10A for through-going busbars only.

Type	Qty.	Order No.
WDK 2.5 2D	25	1023500000

Conductor 2.5 mm² with wire end ferrule with plastic collar only with diameter optimised collar (Order No. 1333100000, Qty. 500)

Type	Qty.	Order No.
WDK 2.5/D	100	1023200000

Type	Current [A]	Qty.	Qty.

Current [A]			
WQV 2.5/2	32	50	1053660000
WQV 2.5/3	32	50	1053760000
WQV 2.5/4	32	50	1053860000
WQV 2.5/4	32	50	1053860000

Width [mm]			
WAP WDK2.5	1.5	20	1059100000
WEW-35/2	8	100	1061200000

SD 0.6X3.5X100		10	9008330000
----------------	--	----	------------

--	--	--	--

WS 8/5 / DEK 5			
----------------	--	--	--

Type	Current [A]	Qty.	Qty.

Current [A]			
WQV 2.5/2	32	50	1053660000
WQV 2.5/3	32	50	1053760000
WQV 2.5/4	32	50	1053860000
WQV 2.5/4	32	50	1053860000

Width [mm]			
WAP WDK2.5	1.5	20	1059100000
WEW-35/2	8	100	1061200000

SD 0.6X3.5X100		10	9008330000
----------------	--	----	------------

--	--	--	--

WS 8/5 / DEK 5			
----------------	--	--	--

Terminals with electronic components

WDK 2.5 LD + -

2.5 mm²

DC voltage indicator + / -

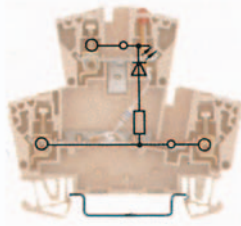

5.1 x 69 x 63
10 / 4
0.13 ... 4

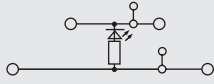

IEC 60947-7-1

IEC	UL	CSA	EN 50019
24			
10			
2.5			
	0.8 / 3		
	A3 / V-0		

24 / 5

Rated connection
0.5...4 / 1.5...4
0.5...4 / 0.5...2.5
0.4...0.6 (M 2.5)
10 / 3.5 x 0.6

Additional connection

WDK 2.5 LD - +

2.5 mm²

DC voltage indicator + / -

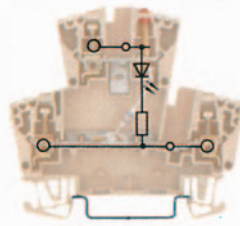

5.1 x 69 x 63
10 / 4
0.13 ... 4

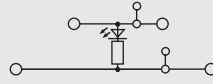

IEC 60947-7-1

IEC	UL	CSA	EN 50019
24			
10			
2.5			
	0.8 / 3		
	A3 / V-0		

24 / 5

Rated connection
0.5...4 / 1.5...4
0.5...4 / 0.5...2.5
0.4...0.6
10 / 3.5 x 0.6

Additional connection

Type	Qty.	Order No.
WDK 2.5 LD ROT 1R 24VDC	25	102360000
WDK 2.5 LD GR 1R 24VDC	25	8023610000

Conductor 2.5 mm² with wire end ferrule with plastic collar only with diameter optimised collar (Order No. 1333100000, VPE 500)

Type	Qty.	Order No.
WDK 2.5 LD ROT 1R 24VDC	25	8023630000
WDK 2.5 LD GR 1R 24VDC	25	8010040000

Conductor 2.5 mm² with wire end ferrule with plastic collar only with diameter optimised collar (Order No. 1333100000, VPE 500)

Type	Current [A]	Qty.	Qty.
Current [A]			
WQV 2.5/2	32	50	1053660000
WQV 2.5/3	32	50	1053760000
WQV 2.5/4	32	50	1053860000
WQV 2.5/4	32	50	1053860000
Width [mm]			
WAP WDK2.5	1.5	20	1059100000
Width [mm]			
WEW-35/2	8	100	1061200000
SD 0.6X3.5X100		10	9008330000
WS 8/5 / DEK 5			

Type	Current [A]	Qty.	Qty.
Current [A]			
WQV 2.5/2	32	50	1053660000
WQV 2.5/3	32	50	1053760000
WQV 2.5/4	32	50	1053860000
WQV 2.5/4	32	50	1053860000
Width [mm]			
WAP WDK2.5	1.5	20	1059100000
Width [mm]			
WEW-35/2	8	100	1061200000
SD 0.6X3.5X100		10	9008330000
DEK 5 / WS 8/5			

Articles with coloured order number are kept permanently in stock at the central warehouse in Germany. Delivery times see page X.2

Accessories

Supplementary functions

Weidmüller offers the user of W-series terminals an extensive range of accessories for the ideal solution to all possible tasks, even over and beyond standard functions.

The accessories meet the same quality standards as the actual terminals.

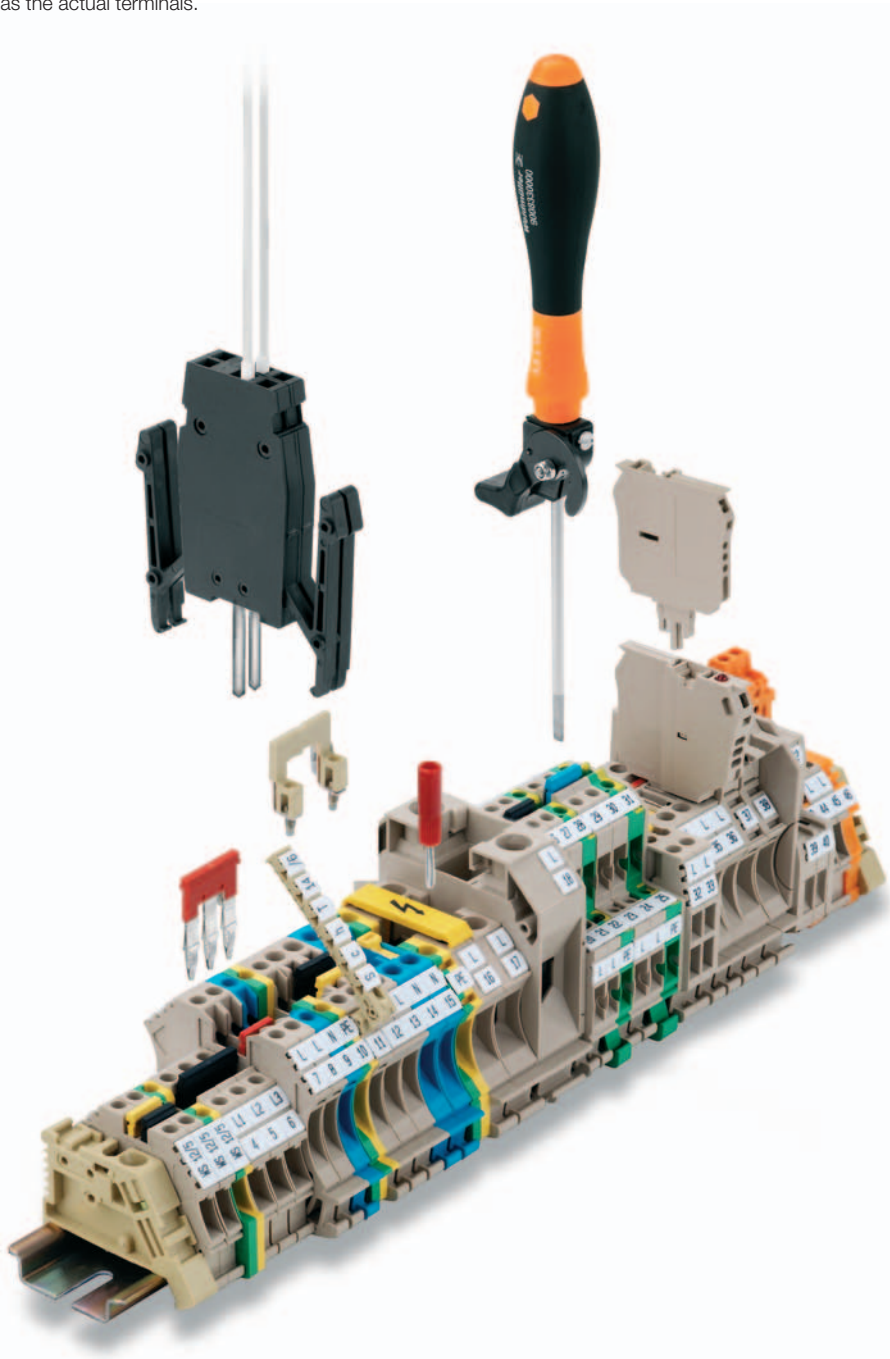

Visual separation

Side covers

Page D.70

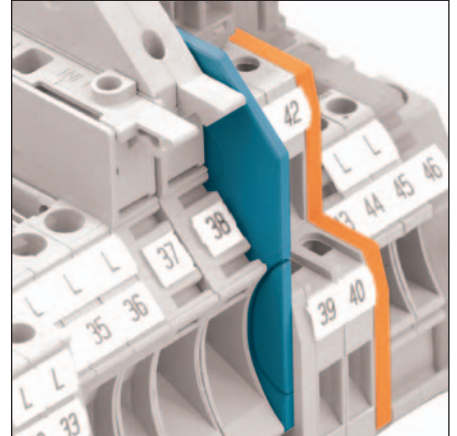

To guarantee finger-safe use of terminals, open sides are covered with end plates and partition plates to prevent any contact with live parts. End plates and partition plates also come in different colours so that they can be used for visual separation of different circuits.

Labelling

Chapter M, page D.84

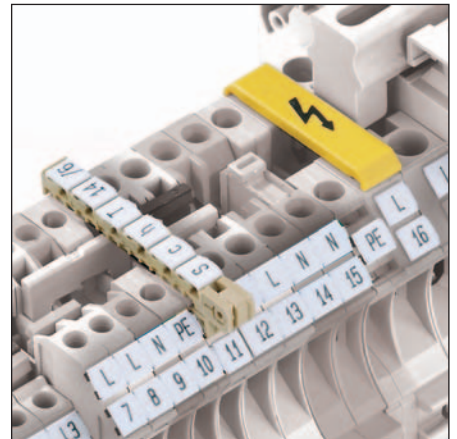

Weidmüller's labelling systems in **Section M** are used to label screw terminals. Individual clamping points, terminal groups and conductors can be marked.

The cover (WAD) can also be used for labelling mains supply points (see **page D.84**)

Fastening

Page F.30

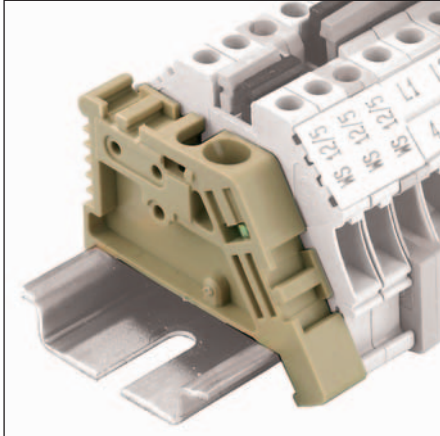

An end bracket is fitted to the right and left of the terminals to locate the terminals on the mounting rail.

The marking surface of the end bracket can also be used for group marking.

Please turn to **Section F** for the wide range of Weidmüller end brackets and mounting rails.

Electrical supply

Page D.72



For the W-series, power is supplied via standard terminals in conjunction with a special cross-connection, which directly connects terminals for larger and smaller cross-sections (the picture shows WDU 35 on WDU 4).

It is possible to form a link to screw-in cross-connectors of smaller cross-sections (WQV 2.5/4/6). This extends electrical distribution to any number of other terminals of the smaller cross-section.

Electrical distribution

Page D.74

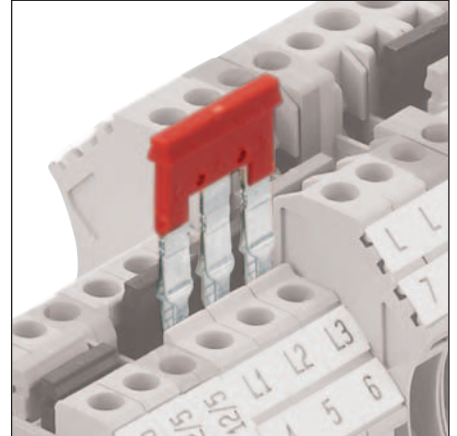

A screw-in and a pluggable cross-connection system is available for Weidmüller screw terminals.

The pluggable **cross-connector (ZQV)** for screw terminals is unique. It enables considerable reductions in assembly times. The pluggable cross-connections can be used for nearly all W-series terminals in the cross-section ranges 2.5 and 4 mm².

Connecting

Chapter N

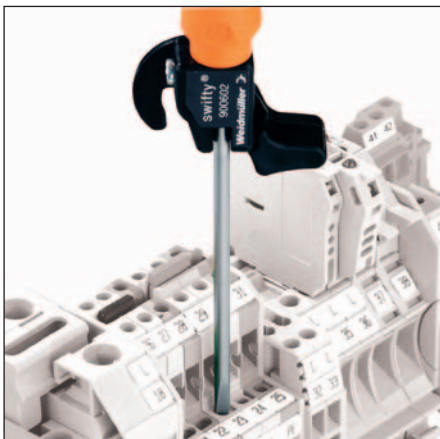

Conductors are connected into Weidmüller terminals using standard screwdrivers, as shown in **Section N**.

Testing

Page D.82

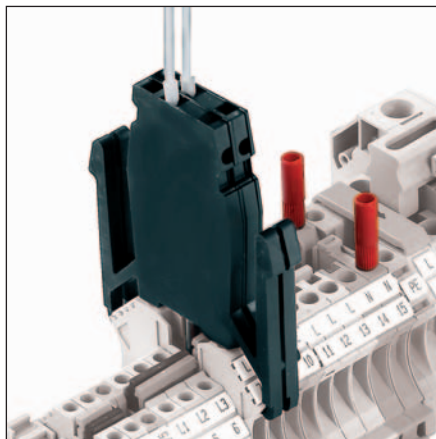

The snap-in test adapter (WTA) is used as a single slice and as a test adapter strip for measurements in switchboards.

The test adapter is ideal for convenient, rational testing of assembled terminals.

It is also possible to perform tests with a socket contact and test plug (page D.79).

Specific functions/ colour variations

Page B.85

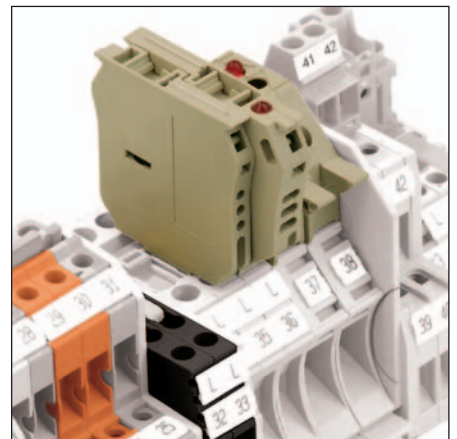

Further helpful accessories are available for screw connection terminals including:

- Plug-in fuse holder (SIHA 1 and SIHA 2)
- Screen plug (LS), shorting plug (WDS)
- Extension connectors (WZAD)
- PEN bridges
- Accessories for measuring and isolating terminals
- Terminals in various colours
- Pre-fitted terminal blocks

Accessories – Visual separation / side covers

End plates



Shock protection

Apart from only a few exceptions, the last terminal of a terminal strip must be covered with an end plate type WAP/AP. End plates are also to be inserted in a terminal strip with different sized terminals.

This guarantees protection from live parts and ensures that the terminals are finger-safe (DIN VDE 0106-100).

Visual separation

Coloured end plates are frequently used for visual separation of power circuits.

Guaranteed operating voltage

End plates can also be used for observing the necessary air and creepage clearances to ensure the rated voltage for the application. For example, when cross-connections are positioned immediately adjacent to each other.

Identical contours

The outer dimensions of the end plates correspond to the cover dimensions of the corresponding terminal.

Mounting

The end plate can be simply clipped onto the corresponding terminal with clip-in pivot.

Corresponding indentations in the terminal allow the terminals to be correctly located.



... for standard design

Type	Colour	Qty.	Order No.	for terminal:		
1.5 mm thick						
WAP 2.5-10	dark beige	50	1050000000	WDU 1.5ZZ	WTR 2.5/SI	WPE 1.5ZZ
WAP 2.5-10 BL	blue	50	1050080000	WDU 2.5/1.5/ZR	WTR 4/SI	WPE 2.5/1.5/ZR
WAP 2.5-10 OR	orange	50	1050060000	WDU 2.5	WSI 6...	WPE 2.5
WAP 2.5-10 BR	brown	50	1050070000	WDU 4	WSI 6/2...	WNT 2.5
WAP 2.5-10 GE	yellow	50	1050020000	WDU 6	WDU 2.5 F	WNT 4
WAP 2.5-10 GN	green	50	1072200000	WDU 10	WDU 2.5 FF	WNT 6
WAP 2.5-10 GR	grey	50	1050050000	WTR 2.5	WDU 4 SL	WNT 10
WAP 2.5-10 RT	red	50	1050040000	WTR 2.5 STB	WDU 6 SL	WDU 2.5/TC..
WAP 2.5-10 SW	black	50	1050010000	WTR 2.5 D	WDU 10 SL	WPO 4
WAP 2.5-10 VI	violet	50	1072210000	WTR 4	WTR 4 SL	
WAP 2.5-10 WS	white	50	1050090000	WTR 4 STB	WTR 4 SI SL	
1.5 mm thick						
WAP 16-35 WTW 2.5-10	dark beige	20	1050100000	WDU 16		
WAP 16-35 WTW 2.5-10 BL	blue	20	1050180000	WDU 35		
WAP 16-35 WTW 2.5-10 OR	orange	20	1050160000			
1.5 mm thick						
WAP WDK 2.5	dark beige	20	1059100000	WDK 2.5	WDK 2.5 PE	WDK 2.5 D...
WAP WDK 2.5 BL	blue	20	1059180000	WDK 2.5 ZQV	WDK 2.5 F	WDK 2.5 LD...
WAP WDK 2.5 GN	green	20	1059140000	WDK 2.5 V	WDK 2.5 FV	
WAP WDK 2.5 WS	white	20	1790910000	WDK 2.5 DU-PE	WDK 2.5 FF	
1.5 mm thick						
WAP WTR 2.5/ZZ	dark beige	20	1074600000	WTR 2.5/ZZ		
WAP WTR 2.5/ZZ BL	blue	20	1074680000			
1.5 mm thick						
WAP WDL 2.5/S	dark beige	20	1067700000	WDL 2.5/S...		
1.5 mm thick						
WAP WDL 2.5	dark beige	20	1067800000	WDL 2.5...		
2.5 mm thick (...ZA = with pivot)						
WAP WDU 1.5/BLZ/ZA	dark beige	50	1577320000	WDU 1.5/BLZ...		
WAP WDU 1.5/BLZ	dark beige	50	1577330000			
2.5 mm thick (...ZA = with pivot)						
WAP WDK 2.5/BLZ/ZA	dark beige	20	1070100000	WDK 2.5/BLZ...		
WAP WDK 2.5/BLZ	dark beige	20	1070000000			
1.5 mm thick						
AP DLI2.5 DB	dark beige	20	1783550000	DLI 2.5 DB...	DLA 2.5 DB...	
1.5 mm thick						
AP DLD2.5 DB	dark beige	20	1784210000	DLD 2.5 DB		
1.5 mm thick						
WAP WTL 6.1	dark beige	20	1068300000	WTL 6.1...	WTQ 6.1...	
WAP WTL 6.1 RT	red	20	1068360000	WTD 6.1...		
2.0 mm thick						
ZAP/TW 1	dark beige	50	1608740000	WTL 4...		
ZAP/TW 1 BL	blue	50	1608750000			
ZAP/TW 1 OR	orange	50	1608760000			
1.5 mm thick						
WAP WDU 1.5/R3.5	dark beige	20	1754190000	WDU 1.5/ R3.5	WPE 1.5/ R3.5	
1.5 mm thick						
WAP WDK 1.5/R3.5	dark beige	20	1754200000	WDK 1.5/ R3.5		
1.5 mm thick						
AP AKZ1.5	beige PA	50	0340560000	AKZ 1.5		
AP AKZ1.5 BL	blue PA	50	0340580000			
2.5 mm thick						
AP AKZ2.5	beige PA	50	0697360000	AKZ 2.5		
AP AKZ2.5 BL	blue PA	50	0697380000			
1.5 mm thick						
AP AKZ4	beige PA	50	0294460000	AKZ 4		
AP AKZ4 BL	blue PA	50	0294480000			

Accessories – Visual separation / side covers

End plate for compact design

Type	Colour	Qty.	Order No.	for terminal:
1.5 mm thick				
WAP WDU 2.5N/4N	dark beige	50	1060000000	WDU 2.5N
WAP WDU 2.5N/4N BL	blue	50	1060080000	WDU 4N
WAP WDU 2.5N/4N GE	yellow	50	1060090000	
WAP WDU 2.5N/4N OR	orange	50	1060060000	

1.5 mm thick				
WAP WDK 2.5/4N	dark beige	20	1084000000	WDK 2.5N
WAP WDK 2.5/4N BL	blue	20	1084080000	WDK 2.5N V WDK 2.5N DU-PE WDK 2.5N PE WDK 4N WDK 4N V WDK 4N DU-PE WDK 4N PE

Partition plates



Guaranteed operating voltage

The main function of the partition plates is to preserve the necessary creepage and air clearances, depending on the operating voltage, for example in applications with increased protection (ATEX) or neighbouring cross-connection groups.

This is why the partition plates are much larger than the corresponding terminals.

Visual separation

The partition plates can be used for very clear visual separation of circuits on one terminal strip.

Dimensions

WAP 16+35 WTW 2.5-10

Length	60 mm
Height with TS 35 x 7.5	63 mm

WTW EN

Length	86 mm
Height with TS 35 x 7.5	63 mm

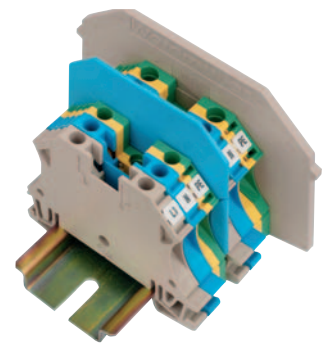

Type	Colour	Qty.	Order No.	for terminal:
1.5 mm thick				
WAP 16-35 WTW 2.5-10	dark beige	20	1050100000	WDU 1.5/ZZ
WAP 16-35 WTW 2.5-10 BL	blue	20	1050180000	WDU 2.5/1.5/ZR
WAP 16-35 WTW 2.5-10 OR	orange	20	1050160000	WDU 2.5 - 35 WDU 2.5 F... WDU 2.5/TC WDU 4 SL - 10 SL WPE 2.5 - 35 WNT 2.5-10 WTR 2.5... WTR 4... WSI 6... WPO 4
3.0 mm thick				
WTW EN	dark beige	20	1058800000	WDK 2.5... WDK 2.5 F... WDK 2.5N... WDK 4N...

Accessories – Potential supply

Potential supply with cross-section reduction

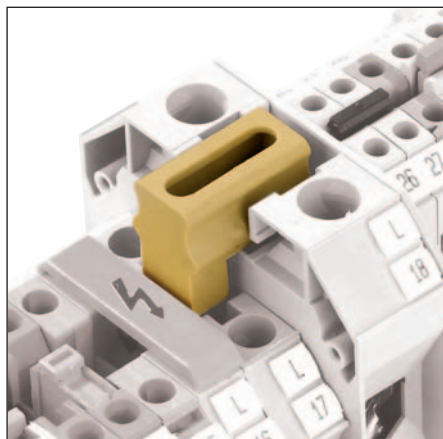

Feed-through terminals such as WDU 35 or WDU 16 are responsible for potential supply in the W-series. The potential is routed by the cross-connectors shown to terminals of a smaller cross-section (cross-section reduction).

D

After cross-section reduction, the potential can then be distributed on to any number of terminals of this same cross-section, using standard cross-connectors.

Function

- Larger conductor cross-section can be used for power supply
- Central potential supply and distribution to any number of circuits.

Mounting



First, prepare the **standard cross-connector** that is to distribute the potential to other terminals of smaller conductor cross-section. To do so, break off the plastic screwdriver guide at the first pole of the cross-connector by bending it back and forth at the intended break-off point, and remove the fixing screw. Then place the cross-connector in the middle of the terminal.

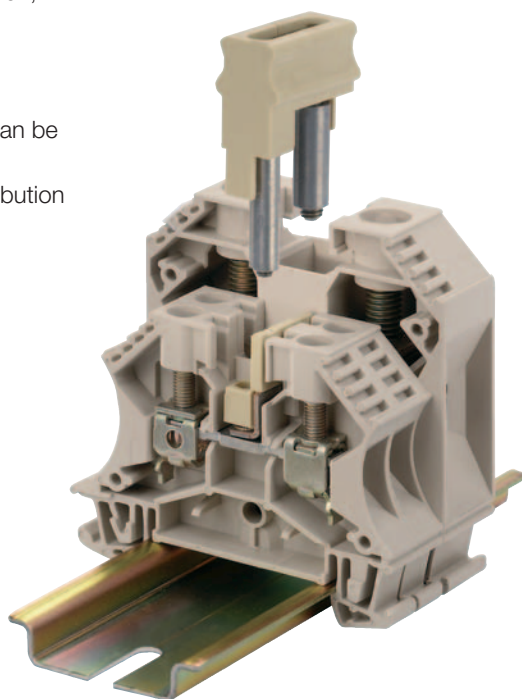

Now insert the **cross-connector for cross-section reduction** so that there is an overlap of the live parts of the first terminal of the smaller cross-section. Fasten with the screws in the cross-section reduction.





Important! The “QL” cross-section reductions are not finger-safe. This can be easily remedied by using the WAD covers for the corresponding terminals.

Accessories – Potential supply

Cross-connectors for potential supply (cross-section reduction)

Power supply via





WDU 35

Outgoing terminal	WDU 2.5	WDU 4 / WDU 6	WDU 10	WDU 16
				
Technical data	to WDU 35	to WDU 35	to WDU 35	to WDU 35
Continuous current 2-pole	41	41	57	76
Thread size	M 4	M 4	M 4	M 4
Tightening torque	1.2 ... 1.8	1.2 ... 1.8	1.2 ... 1.8	1.2 ... 1.8
	to WDU 2.5	to WDU 4 / 6	to WDU 10	to WDU 16
	M 2.5	M 3	M 3	M 4
	0.4 ... 0.7	0.5 ... 0.8	0.5 ... 0.8	1.2 ... 1.8
	1.2 ... 1.8	0.5 ... 0.8	1.2 ... 1.8	1.2 ... 1.8
Order data	Type Qty Order No.	Type Qty Order No.	Type Qty Order No.	Type Qty Order No.
2-pole	WQV 35-2.5 10 1064100000	WQV 35-4/6 10 1064200000	WQV 35-10 10 1068000000	WQV 16/2 50 1053260000

Power supply via

WDU 16





WDU 10

Outgoing terminal	WDU 2.5	WDU 4 / WDU 6	WDU 2.5	WDU 4
				
Technical data	to WDU 16	to WDU 16	to WDU 10	to WDU 10
Continuous current 2-pole	41	41	24	32
Thread size	M 4	M 4	M 3	M 3
Tightening torque	1.2 ... 1.8	1.2 ... 1.8	0.5 ... 0.8	0.5 ... 0.8
	to WDU 2.5	to WDU 4 / 6	to WDU 2.5	to WDU 4
	M 2.5	M 3	M 2.5	M 3
	0.4 ... 0.7	0.5 ... 0.8	0.4 ... 0.7	0.5 ... 0.8
	1.2 ... 1.8	0.5 ... 0.8	0.5 ... 0.8	0.5 ... 0.8
Order data	Type Qty Order No.	Type Qty Order No.	Type Qty Order No.	Type Qty Order No.
2-pole	WQV 16-2.5 10 1063900000	WQV 16-4/6 10 1064000000	QL 10-2.5 10 185962000	QL 10-4 10 1859610000
			not finger-safe	not finger-safe

Power supply via

WDU 16N

WDU 6

Outgoing terminal	WDU 2.5	WDU 4 / WDU 6	WDU 10	WDU 2.5
				
Technical data	to WDU 16	to WDU 16N	to WDU 16N	to WDU 6
Continuous current 2-pole	24	41	24	24
Thread size	M 3	M 3	M 3	M 3
Tightening torque	0.5 ... 0.8	0.5 ... 0.8	0.5 ... 0.8	0.5 ... 0.8
	to WDU 2.5	to WDU 4 / 6	to WDU 10	to WDU 2.5
	M 2.5	M 3	M 3	M 2.5
	0.4 ... 0.7	0.5 ... 0.8	0.5 ... 0.8	0.4 ... 0.7
	1.2 ... 1.8	0.5 ... 0.8	0.5 ... 0.8	1.2 ... 1.8
Order data	Type Qty Order No.	Type Qty Order No.	Type Qty Order No.	Type Qty Order No.
2-pole	WQV 16N-2.5 10 1073100000	WQV 16N-4/6 10 1072500000	WQV 16N-10 10 1073400000	QL 6-2.5 10 1859600000
				not finger-safe

Articles with coloured order number are kept permanently in stock at the central warehouse in Germany. Delivery times see page X.2

Accessories – Electrical distribution

Pluggable cross-connection ZQV

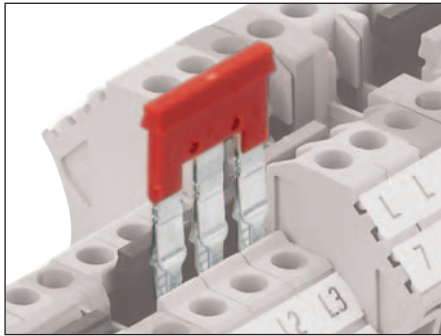

Unique for screw terminals

Weidmüller is the only producer to offer a pluggable cross-connection system for screw terminals. The pluggable cross-connections stand out with their easy handling and quick assembly, resulting in considerable time savings compared to screwed assembly solutions.

D

Assembly

- The ZQV is pressed into the cross-connection channel by hand.
- **Important!** Ensure that the ZQV is pressed right in. The cross-connector must not protrude out of the cross-connection channel.
- To replace or remove, simply lever out with a screwdriver.

Technical information

- Finger-safe to VDE 0160 part 100 (VGB 4)
- Reduced rated voltage 400 V
- Different colours can be used to mark different potential
- **Important!** The contact elements must not be deformed.

In one cross-connection channel

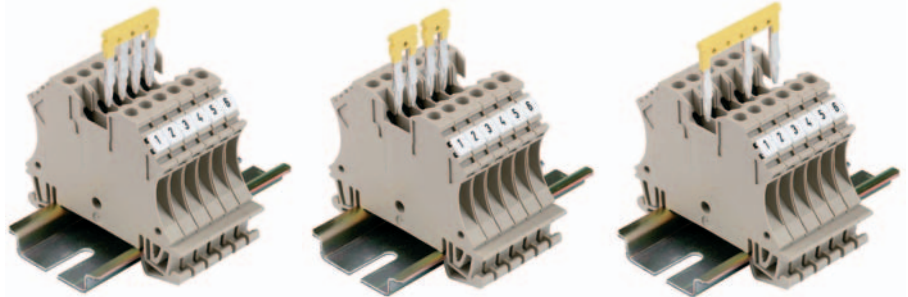
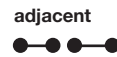

In two cross-connection channels

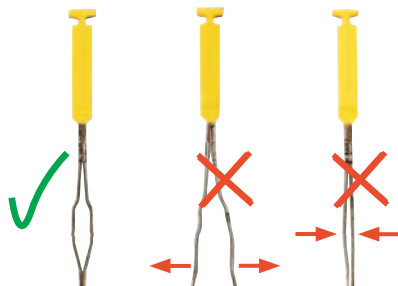
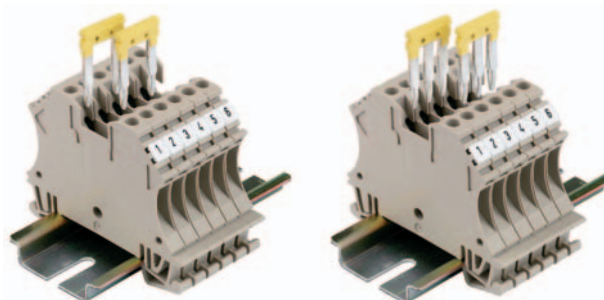
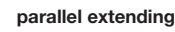
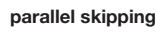

Possible cross-connections of terminals of the same type with appropriate cross-connectors

Terminal type	Cross-connector	single	adjacent	skipping	parallel skipping	parallel extending
Standard						
WDU 1.5/ R3.5	ZQV 1.5/ R3.5	•	•	•		
WDK 1.5/ R3.5	ZQV 1.5/ R3.5	•	•	•		
WDU 2.5/1.5/ZR	ZQV 2.5N	•	•	•	•	•
WDU 2.5	ZQV 2.5N	•	•	•	•	•
WDK 2.5 ZQV	ZQV 2.5N	•	•	•		
WTR 2.5/ZZ	ZQV 2.5	•	•	•		
WDU 4	ZQV 4N	•	•	•	•	•
WTR 4...	ZQV 4N	•	•	•		
Compact						
WDU 2.5N ZQV	ZQV 2.5N	•	•	•	•	•
WDK 2.5N...	ZQV 2.5N	•	•	•		
WDK 2.5N PE	ZQV 2.5N	•	•	•		
WDU 4N	ZQV 4N	•	•	•	•	•
WDK 4N...	ZQV 4N	•	•	•		
WDK 4N PE	ZQV 4N	•	•	•		

Accessories – Electrical distribution

ZQV pluggable cross-connector

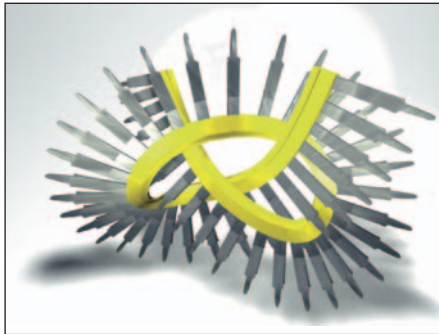

Continuous cross-connector

ZQV 2.5N/50 (50-pole) and ZQV 4N/41 (41-pole) are ideal for shortening (e.g. with tool KT ZQV-9002170000) to produce customised configurations with the required number of poles.

More than 25 poles in a row are not recommended because of the resulting tolerances in the terminals.

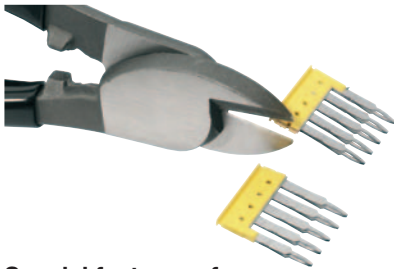

Special features of WDU 2.5, WDU 4 and WDU 2.5/1.5/ZR

- Parallel distribution of 3 potentials
Important! Rated voltage reduced to 125 V!
- Parallel distribution of 2 potentials
Important! Only when using the outer cross-connection holes at 400V
- The middle cross-connection hole can be used for either ZQV or WQV

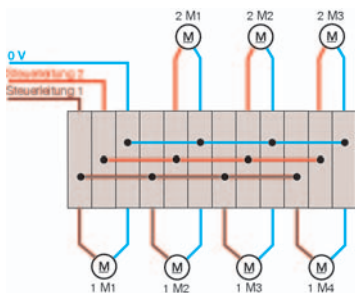

Important! For shortened ZQV located adjacent to each other (with bare cut edges), end plates or partition plates are necessary for rated voltage of 250 V

ZQV 2,5N

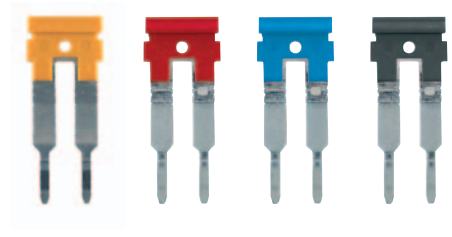

No. of poles	Type	Qty	Order no. yellow	Order no. red	Order no. blue	Order no. black
2	ZQV 2.5N/2	60	1693800000	1717900000	1717990000	1718080000
3	ZQV 2.5N/3	60	1693810000	1717910000	1718000000	1718090000
4	ZQV 2.5N/4	60	1693820000	1717920000	1718010000	1718100000
5	ZQV 2.5N/5	20	1693830000	1717930000	1718020000	1718110000
6	ZQV 2.5N/6	20	1693840000	1717940000	1718030000	1718120000
7	ZQV 2.5N/7	20	1693850000	1717950000	1718040000	1718130000
8	ZQV 2.5N/8	20	1693860000	1717960000	1718050000	1718140000
9	ZQV 2.5N/9	20	1693870000	1717970000	1718060000	1718150000
10	ZQV 2.5N/10	20	1693880000	1717980000	1718070000	1718160000
50	ZQV 2.5N/50	10	1693890000	1718170000	1718180000	1718190000
	for standard terminal		for compact terminal			
	WDU 2.5/1.5 ZR		WDU 2.5N			
	WDU 2.5		WDK 2.5N			
	WDK 2.5/ ZQV		WDK 2.5N V			
	WDU 1.5 BLZ 5.08/ ZQV		WDK 2.5N DU-PE			

ZQV 4N

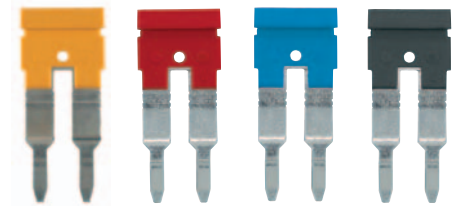

No. of poles	Type	Qty	Order no. yellow	Order no. red	Order no. blue	Order no. black
2	ZQV 4N/2	60	1758250000	1793950000	1793960000	1793970000
3	ZQV 4N/3	60	1762630000	1793980000	1793990000	1794000000
4	ZQV 4N/4	60	1762620000	1794010000	1794020000	1794030000
5						
6						
7						
8						
9						
10	ZQV 4N/10	20	1758260000	1794040000	1794050000	1794060000
41	ZQV 4N/41	10	1758270000	1794070000	1794080000	1794090000
	for standard terminal		for compact terminal			
	WDU 4		WDU 4N			
	WTR 4		WDK 4N			
	WTR 4 SI		WDK 4N V			
	WTR 4 SL		WDK 4N DU-PE			

Accessories – Electrical distribution

WQV screw cross-connector



When used together with W-series terminals, WQV insulated cross-connection units guarantee absolute safety for finger and back-hand in accordance with the accident prevention regulation "Electrical systems and equipment" (VGB4).

It is very easy to produce individual configurations thanks to the many different options offered by the WQV cross-connection system, by breaking out individual segments, creating any required number of poles or routing two potentials in parallel, etc.

Technical instructions

- The full rated current of the terminals can be routed across any number of poles.
- No end plates or partition plates needed for adjacent WQV up to 400 V.

Assembly

- Place the WQV in the cross-connection channel in the middle of the terminal and screw tight.
- Individual WQV segments can be broken out by bending over or using the WAW1 tool. It is then possible to bridge individual or several terminals.
- Captive fixing screws.
- Snap onto the clamped support – simple overhead assembly.

Any number of poles (extending)

Pre-fitted cross-connectors can be set one after the other to produce any required number of poles.

To do so, arrange the last and first contact points of two identical WQVs so that they overlap.

- First, remove the fixing screw and screwdriver guide (insulated part) at one of the outer contact points of one of the WQVs.



- Then insert the WQV without fixing screw and insulated part. At the same time, insert an unmodified WQV in parallel so as to produce an overlap at the connection. The connection is screwed tight using the fixing screw of the unmodified WQV.

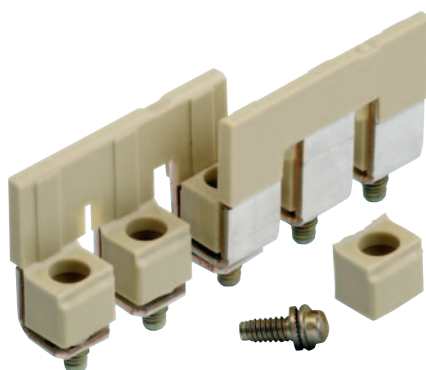

Routing 2 potentials in parallel

- In spite of only having 1 channel, the WQV cross-connection system can still be used for offset cross-connections. See the photo "parallel skipping".

WQV in combination with a socket contact and test plug

- Remove the fixing screw and insulation part of the WQV. Screw the socket in at this point. This now makes it possible to integrate a safe test point.

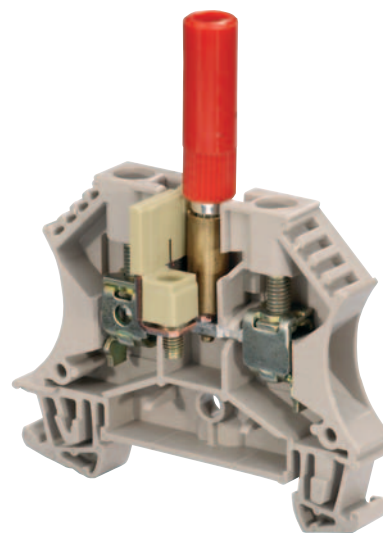

Accessories – Electrical distribution

Screw-in cross-connector – possible combinations

In one cross-connection channel

single

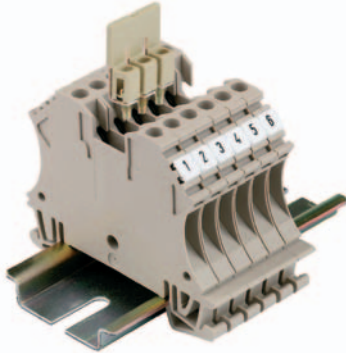

adjacent

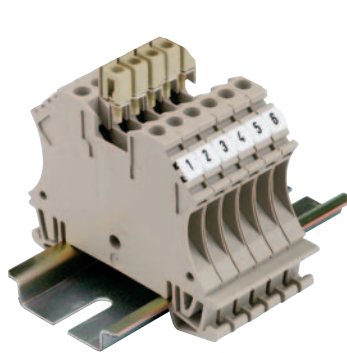

skipping

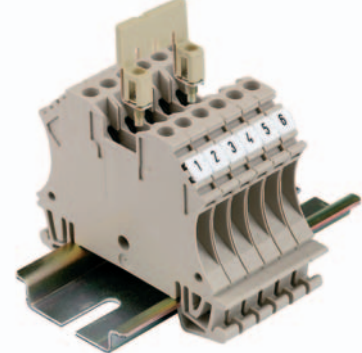

parallel skipping

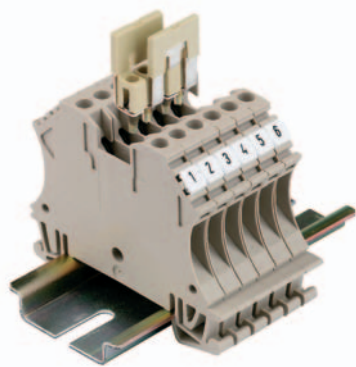

extending

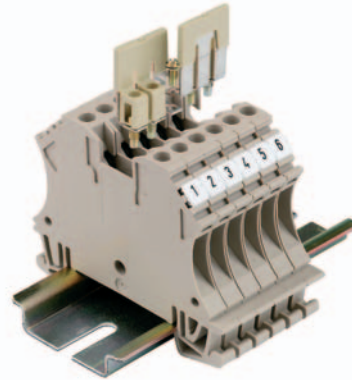

Possible cross-connections of terminals of the same type with appropriate cross-connectors

Terminal type	Cross-connection	single	adjacent	skipping	parallel skipping	extending
Standard						
WDU 1.5/ZZ	WQV 2.5	•	•	•	•	•
WDU 1.5/BLZ	WQV 2.5	•	•	•	•	•
WDU 2.5/1.5/ZR	WQV 2.5	•	•	•	•	•
WDU 2.5 - WDU 35	WQV 2.5 - WQV 35	•	•	•	•	•
WDK 2.5...	WQV 2.5	•	•	•	•	•
WDK 2.5 PE	WQV 2.5	•	•	•	•	•
WDU 2.5/BLZ	WQV 2.5	•	•	•	•	•
WDK 2.5/BLZ	WQV 2.5	•	•	•	•	•
WDU 2.5 F...	WQV 2.5	•	•	•	•	•
WDK 2.5 F...	WQV 2.5	•	•	•	•	•
WDU 4 SL - WDU 10 SL	WQV 4 - WQV 10	•	•	•	•	•
WDU 70/95	WQV 70/95	•	•	•	•	•
WDU 120/150	WQV 120/150	•	•	•	•	•
WDU 240	WQB 240	•	•	•	•	•
Compact						
WDU 2.5N	WQV 2.5	•	•	•	•	•
WDU 2.5N 600V	WQV 2.5	•	•	•	•	•
WDU 16N	WQV 16N	•	•	•	•	•
WDU 35N	WQV 35N	•	•	•	•	•
WDU 50N	WQV 50N	•	•	•	•	•
WDU 95N/120N	WQV 95N/120N	•	•	•	•	•

Accessories – Electrical distribution

Screw-in cross-connectors

WQV 2.5



Technical data	
Continuous current 2-pole/multi-pole	A
Thread size	M 2.5
Tightening torque	Nm
Order data	
2-pole	WQV 2.5/2
3-pole	WQV 2.5/3
4-pole	WQV 2.5/4
5-pole	WQV 2.5/5
6-pole	WQV 2.5/6
7-pole	WQV 2.5/7
8-pole	WQV 2.5/8
9-pole	WQV 2.5/9
10-pole	WQV 2.5/10
15-pole	WQV 2.5/15
32-pole	WQV 2.5/32

Type	Qty	Order No.
32 / 32		
M 2.5		
0.4 ... 0.7		
WQV 2.5/2	50	1053660000
WQV 2.5/3	50	1053760000
WQV 2.5/4	50	1053860000
WQV 2.5/5	10	1053960000
WQV 2.5/6	10	1054060000
WQV 2.5/7	10	1054160000
WQV 2.5/8	10	1054260000
WQV 2.5/9	10	1054360000
WQV 2.5/10	20	1054460000
WQV 2.5/15	10	1059660000
WQV 2.5/32		1577600000

for terminal	
WDU 1.5 ZZ	WDK 2.5
WDU 1.5 BLZ	WDK 2.5 V
WDU 2.5/1.5 ZR	WDK 2.5 DU-PE
WDU 2.5	WDK 2.5 F
WDU 2.5 F	

WQV 4



Type	Qty	Order No.
41 / 41		
M 3		
0.5 ... 0.8		
WQV 4/2	50	1051960000
WQV 4/3	50	1054560000
WQV 4/4	50	1054660000
WQV 4/5	10	1057860000
WQV 4/6	10	1057160000
WQV 4/7	10	1057260000
WQV 4/8	10	1057960000
WQV 4/9	10	1058060000
WQV 4/10	20	1758260000
WQV 4/15	10	1057460000

for terminal	
WDU 4	
WDU 4 SL	

WQV 6



Type	Qty	Order No.
57 / 57		
M 3		
0.5 ... 0.8		
WQV 6/2	50	1052360000
WQV 6/3	50	1054760000
WQV 6/4	50	1054860000
WQV 6/5	50	1062660000
WQV 6/6	50	1062670000
WQV 6/7	50	1062680000
WQV 6/10	20	1052260000

for terminal	
WDU 6	
WDU 4 SL	

WQV 35N



Technical data	
Continuous current 2-pole/multi-pole	A
Thread size	M 4
Tightening torque	Nm
Order data	
2-pole	WQV 35N/2
3-pole	WQV 35N/3
4-pole	WQV 35N/4
5-pole	
6-pole	
7-pole	
8-pole	
9-pole	
10-pole	
15-pole	
32-pole	

Type	Qty	Order No.
115 / 100		
M 4		
1.2 ... 1.8		
WQV 35N/2	50	1079200000
WQV 35N/3	50	1079300000
WQV 35N/4	50	1079400000

for terminal	
WDU 35N	

WQV 50N

finger-safe with cover WAD

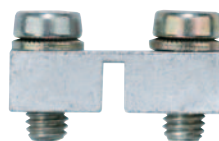

Type	Qty	Order No.
150 / 150		
M 6		
2.5 ... 4.5		
WQV 50N/2	10	1834060000
WQV 50N/3	10	1834070000
WQV 50N/4	10	1834080000

for terminal	
WDU 50N	

WQV 70N

finger-safe with cover WAD

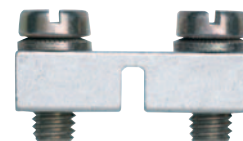

Type	Qty	Order No.
192 / 192		
M 6		
2.5 ... 4.5		
WQV 70N/2	5	9512240000
WQV 70N/3	5	9512250000
WQV 70N/4	5	9531290000

for terminal	
WDU 70N	

Accessories – Electrical distribution

D

WQV 10



76 / 63		
M 3		
0.5 ... 0.8		
Type	Qty	Order No.
WQV 10/2	50	1052560000
WQV 10/3	50	1054960000
WQV 10/4	50	1055060000
WQV 10/10	20	1052460000
for terminal		
WDU 10		
WDU 10 SL		
WDU 10 ZR		

WQV 16



101 / 76		
M 4		
1.2 ... 1.8		
Type	Qty	Order No.
WQV 16/2	50	1053260000
WQV 16/3	50	1055160000
WQV 16/4	50	1055260000
WQV 16/10	10	1053360000
for terminal		
WDU 16		

WQV 16N

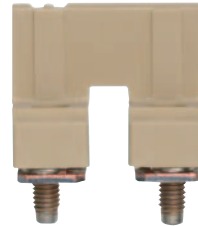

76 / 57		
M 4		
1.2 ... 1.8		
Type	Qty	Order No.
WQV 16N/2	50	1636560000
WQV 16N/3	50	1636570000
WQV 16N/4	50	1636580000
for terminal		
WDU 16N		

WQV 35



138 / 112		
M 4		
1.2 ... 1.8		
Type	Qty	Order No.
WQV 35/2	50	1053060000
WQV 35/3	50	1053360000
WQV 35/4	50	1055460000
for terminal		
WDU 35		

WQV 70

finger-safe with cover WAD



232 / 232		
M 5		
2.0 ... 4.0		
Type	Qty	Order No.
WQV 70/2	5	1063500000
WQV 70/3	5	1063600000
for terminal		
WDU 70/95		

WQV 95N/120N

finger-safe with cover WAD

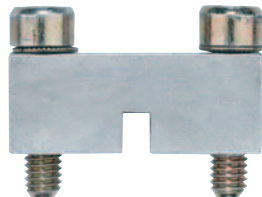

269 / 269		
M 6		
3.0 ... 4.5		
Type	Qty	Order No.
WQV 95N/120N/2	5	1826890000
WQV 95N/120N/3	5	1826900000
for terminal		
WDU 95N/120N		

WQV 120

finger-safe with cover WAD

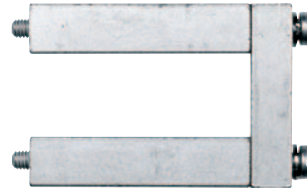

292 / 292		
M 5		
2.0 ... 4.0		
Type	Qty	Order No.
WQV 120/2	5	1063300000
WQV 120/3	5	1063400000
for terminal		
WDU 120/150		

Articles with coloured order number are kept permanently in stock at the central warehouse in Germany. Delivery times see page X.2

Accessories – Electrical distribution

Q screw-in cross-connectors

With this cross-connector, the cross-connection lugs, sleeves and fixing screws are pre-fitted. All individual parts are also available separately on request. Cross-connectors pre-fitted in this way are simply placed in the middle of the terminal and screwed tight. Any required number of poles is possible by combining two cross-connectors. For example, a 20-pole cross-connection is made up by connecting two 10-pole cross-connectors with the cross-connection strap of a 2-pole cross-connector (as shown).

D

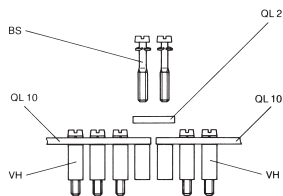

Q ... AKZ 4SS



Technical data	
Continuous current 2-pole/multi-pole	A
Thread size	M 2.5
Tightening torque	Nm

Order data	
2-pole	
3-pole	
4-pole	
10-pole	
24-pole	

32 / 32
M 2.5
0.4 ... 0.6

Type	Qty	Order No.
Q...2 AKZ 4SS		0369000000
Q...3 AKZ 4SS		0369100000
Q...4 AKZ 4SS		0369200000
Q...10 AKZ 4SS		0369300000

for terminal
WDK 2.5 EX

Q ... DLI 2.5



24 / 24
M 2.5
0.4 ... 0.6

Type	Qty	Order No.
Q...2 DLI 2.5		1312500000
Q...3 DLI 2.5		1312600000
Q...4 DLI 2.5		1312700000
Q...10 DLI 2.5		1313100000

for terminal
DLI 2.5
DLA 2.5
DLO 2.5

Q ... AKZ 1.5



24 / 24
M 2.5
0.4 ... 0.6

Type	Qty	Order No.
Q...2 AKZ 1.5	50	0368200000
Q...3 AKZ 1.5	50	0368300000
Q...4 AKZ 1.5	50	0368400000
Q...10 AKZ 1.5	20	0368500000

for terminal
AKZ 1.5
AKZ 2.5

Q ... AKZ 4



32 / 32
M 2.5
0.4 ... 0.6

Type	Qty	Order No.
Q...2 AKZ 4	50	0336400000
Q...3 AKZ 4	50	0336500000
Q...4 AKZ 4	50	0336600000
Q...10 AKZ 4	20	0338600000

for terminal
AKZ 4

Q ... WDL 2.5 / S



24 / 24
M 2.5
0.4 ... 0.6

Type	Qty	Order No.
Q...2 WDL 2.5 / S	50	1071500000
Q...3 WDL 2.5 / S	50	1071600000
Q...4 WDL 2.5 / S	50	1071700000
Q...10 WDL 2.5 / S	10	1071800000

for terminal
WDL 2.5 / S... (with 10 x 3 busbar)
WDL 2.5 / (with disconnector, external side)

Accessories – Electrical distribution

Cross-connection with WTR 2.5 isolating terminal and WSI 6 fuse terminal

Assembly

The cross-connection straps are screwed directly to the busbar. For this purpose, use tool WAW 2 to press out the knockout side window of the clamped support and snap on the terminal. Now open the disconnect element (fuse holder) and insert the fixing screw. Push the cross-connection strap from the side through the knockout of the clamped support and fasten with the screws.

Important! The side window of the last terminal must not be broken out to safeguard the rated voltage.

Use

In WTR 2.5, assembly of the WQB B outside bridge involves less workload. But please note that the conductor cross-section is reduced by one size.

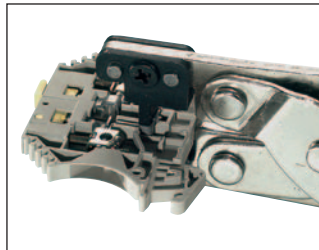
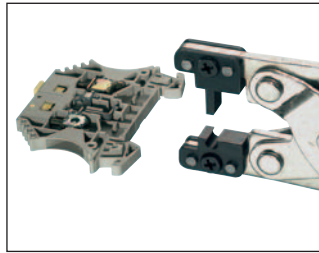

Outside cross-connection bridges

Function

Outside cross-connection bridges allow for current to be bridged in terminals without a cross-connection channel in the middle or when two potentials are to be routed in parallel.

Assembly

These bridges are positioned over the conductor in the clamping point and connected. Individual contacts can be separated off by hand when you wish to skip a clamping point.

Important! Use of these parts reduces the nominal cross-section of the connected conductor to the next smallest size for the terminal in question.



Q L...

WQB A / ...

WQB B / ...



Technical data	
Continuous current 2-pole/multi-pole	A
Fork length	

24 / 24
12 mm

24 / 24
12 mm

24 / 24
16 mm

Order data	
2-pole	
3-pole	
4-pole	
10-pole	
24-pole	
Fixing screw	
Releasing tool	

Type	Qty	Order No.
QL 2	100	1578950000
QL 3	100	1578960000
QL 4	50	1578970000
QL 10	20	1578990000
BS-M 2,5 x 4,5	100	1062700000
WAW 2	1	9004510000

Type	Qty	Order No.
WQB A / 2	50	1578950000
WQB A / 3	50	1578960000
WQB A / 4	50	1578970000
WQB A / 10	50	1578990000
WQB A / 24	50	1579000000

Type	Qty	Order No.
WQB B / 2	50	1579010000
WQB B / 3	50	1579020000
WQB B / 4	50	1579030000
WQB B / 10	50	1579050000
WQB B / 24	50	1579060000

for terminal	
WTR 2.5	
WSI 6...	

for terminal	
WDK 2.5	

for terminal	
WDU 1.5 / ZZ (lower connection level)	
WDU 2..5	
WDU 2.5 / 1.5 / ZR (lower connection level)	
WTR 2.5	

Accessories – Testing

Test adapter

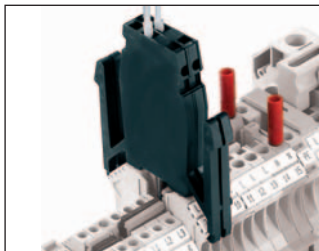

The clip-in test adapter WTA is used as single slice and also as test adapter strip for measurements in switchboards.

Conductors with a cross-section range from 0.5 mm² to 1.5 mm² can be clamped. The test adapter is simply clipped into the terminal for secure contact with the potential-conducting busbar. This connection is released again simply by pressing the release button.

Starting torque for all test adapters
WTA 0.4 ... 0.6 Nm (M 2.5)

Dimensions	
Height (with TS 35 x 7.5)	mm
Length	mm
Width	mm
Stripping length	mm

Rated voltage / current / cross-connection	
to IEC 60 947-7-1	
to UL/CSA	

Clamped conductor	
solid core H 07V-U	mm ²
flexible stranded H 07V-K	mm ²
flexible stranded with AEH (DIN 46228/1)	mm ²

Order data	
	1-pole
	1-pole with clip-in pivot
	10-pole

Marking tags

WTA 1



98.2
66.1
5.0
6.0

250 V / 6.0 A / 1.5 mm ²
300 V / 6.0 A / 1.5 mm ²

0.5 ... 1.5
1.0 ... 1.5
0.5 ... 1.5

Type	Qty	Order No.
WTA 1	25	1632290000
WTA 1/ZA	25	1632300000
WTA 1/10	5	1632310000

for terminal	
WDU 2.5N	
WDU 4N	

Marking tags

WTA 2



107.6
66.1
5.0
6.0

250 V / 6 A / 1.5 mm ²
300 V / 6 A / 1.5 mm ²

0.5 ... 1.5
1.0 ... 1.5
0.5 ... 1.5

Type	Qty	Order No.
WTA 2	25	1632320000
WTA 2/ZA	25	1632330000
WTA 2/10	5	1632340000

for terminal		for terminal
WDU 1.5 ZZ		WDU 4
WDU 2.5/1.5 ZR		WDU 6
WDU 2.5		WDU 10
WDU 2.5 F		WDU 16

Marking tags

WTA 5



Dimensions	
Height (with TS 35 x 7.5)	mm
Length	mm
Width	mm
Stripping length	mm

Rated voltage / current / cross-connection	
to IEC 60 947-7-1	
to UL/CSA	

Clamped conductor	
solid core H 07V-U	mm ²
flexible stranded H 07V-K	mm ²
flexible stranded with AEH (DIN 46228/1)	mm ²

Order data	
	1-pole
	1-pole with clip-in pivot
	10-pole

Marking tags

68.2
17.0
5.0
14

250 V / 6.0 A / 0.75 mm ²
300 V / 6.0 A / 0.75 mm ²

0.5 ... 1.0
1.0
0.5 ... 1.0

Type	Qty	Order No.
WTA 5	25	1051260000
-	-	-
WTA 5/10	5	1062060000

for terminal	
WDU 2.5	WDU 10
WDU 4	WDU 10 ZR
WDU 6	

Marking tags

WTA 6



107.6
66.1
5.0
6.0

250 V / 6.0 A / 1.5 mm ²
300 V / 6.0 A / 1.5 mm ²

0.5 ... 1.5
1.0 ... 1.5
0.5 ... 1.5

Type	Qty	Order No.
WTA 6	25	1632380000
WTA 6/ZA	25	1632390000
WTA 6/10	5	1632400000

for terminal	
WTR 2.5	

Marking tags

Accessories – Testing

WTA 3



107.6
66.1
6.0
6.0

250 V / 6 A / 1.5 mm²
300 V / 6 A / 1.5 mm²

0.5 ... 1.5
1.0 ... 1.5
0.5 ... 1.5

Type	Qty	Order No.
WTA 3	25	1632350000
WTA 3/ZA	25	1632360000
WTA 3/10	5	1632370000

for terminal

WDU 4
WDU 6
WDU 10

DEK 5

WTA 4



125
62
5.0
6.0

250 V / 6 A / 1.5 mm²
300 V / 6 A / 1.5 mm²

0.5 ... 1.5
1.0... 1.5
0.5 ... 1.5

Type	Qty	Order No.
WTA 4	25	1649600000
WTA 4/ZA	25	1649610000
WTA 4/10	5	1649620000

for terminal

WDK 2.5
WDK 2.5 V
WDK 2.5 F
WDK 2.5 FV

DEK 5

WTA 7



120
68
6.0
6.0

250 V / 6.0 A / 1.5 mm²
300 V / 6.0 A / 1.5 mm²

0.5 ... 1.5
1.0 ... 1.5
0.5 ... 1.5

Type	Qty	Order No.
WTA 7	25	1650210000

for terminal

WSI 6

DEK 5

Test plug (PS)



Test plugs (PS) are used for measurements or final testing of ready wired terminal strips. Test plugs are available for socket contacts with an internal diameter of 2.3 mm or 4 mm.

The difference to the test adapter is that the test plug does not slot into the terminal. This means that reliable plugging into feed-through terminals up to 35 mm² is only possible with a socket.

Special feature for large cross-sections

WDU 70N, WDU 95N/120N, WDU 70/95, WDU 120/150

In these terminals, test plug PS 4 can be plugged into the head of the clamping screw for measurements.

Socket (StB)



The StB socket is used for fitting the PS test plug. The sockets are screwed into the busbar in the cross-connection channel in the middle of the terminal.

WTR isolating terminals are available with pre-fitted sockets (see W-series isolating terminals). The sockets are equipped with a slot for the screw-driver.

Combining with WQV

The socket can be used in combination with the WQV screw-in cross-connector. For this purpose, the insulating part of the screw and the fixing screw have to be removed at the corresponding pole in the WQV. The socket can then be screwed in.

StB

Socket	for test plug	Qty	Order No.	for standard terminal	for compact terminal
Thread M 2.5 / Length 11.5 mm					
StB 8.5	PS 2.3	50	0215700000	WDU 1.5/ZZ WDU 2.5/1.5/ZR WDU 2.5 WDK 2.5...	WDU 2.5N (WQV) WDU 2.5N 600V UL
Thread M 3 / Length 12 mm					
StB 8.5	PS 2.3	50	0280600000	WDU 4 WDU 6 WDU 10 WDU 10/ZR	
Thread M 3 / Length 19 mm					
StB 14	PS 4	50	0169900000	WDU 10 WDU 10ZR	WDU 16N
Thread M 4 / Length 23 mm					
StB 16	PS 4	50	0140200000	WDU 16	WDU 35N
Thread M 3 / Length 23 mm (fingersicher)					
StB 21.6	PS 4	50	1071000000	WDU 4 WDU 10	WDU 6

PS

Test plug	Qty	Order No.
Diameter 2.3 mm / Rated current 17.5 A		
PS 2.3	20	0180400000
Diameter 4.0 mm / Rated current 24 A		
PS 4	20	0299600000

Articles with coloured order number are kept permanently in stock at the central warehouse in Germany. Delivery times see page X.2

Accessories – Marking

Marking / Cover



The WAD cover is clipped onto the cross-connection channel in the middle of the terminal from above. The cover is supplied either in yellow with a black warning lightning flash or in white without any printing.

Cover WAD is available for all feed-through terminals in the W-series.

Simple marking

The cover in white without any printing can be used for terminal marking or group marking.

Finger safety for uninsulated cross-connectors

Important! When cross-connecting terminals WDU 70N, WDU 95N/120N, WDU 70/95 and WDU 120/150, finger safety according to the VDE directive is only guaranteed when the WAD cover is used.

Marking mains terminals

The VDE regulations stipulate that mains terminals have to be identified by a warning lightning flash.

WAD

Type	Qty	Order No.	for standard terminal	for compact terminal
WAD 4 yellow*	50	1072000000	WDU 1.5/ZZ	WDU 2.5N...
WAD 4 white	50	1072100000	WDU 2.5/1.5/ZR	WDU 4N WDK 2.5...
WAD 5 yellow*	50	1053460000	WDU 2.5	
WAD 5 white	50	1056060000	WDU 4	
WAD 8 yellow*	50	1053560000	WDU 6	
WAD 8 white	50	1056160000	WDU 10	
WAD 12 yellow*	50	1055960000	WDU 16...	
WAD 12 white	50	1056260000	WDU 35...	
WAD 12N yellow*	50	1073200000		WDU 16N...
WAD 12N white	50	1073290000		
WAD 16N yellow*	50	1083600000		WDU 35N...
WAD 16N white	50	1083500000		
WAD 20 yellow*	20	9512260000		WDU50N
WAD 20 white	20	9512270000		WDU 70N WDU 95N/120N
WAD 27 yellow*	10	1062860000	WDU 70/95	
WAD 27 white	10	1062960000	WDU 120/150	

* with warning flash

Accessories – Specific functions

SIHA fuse holder

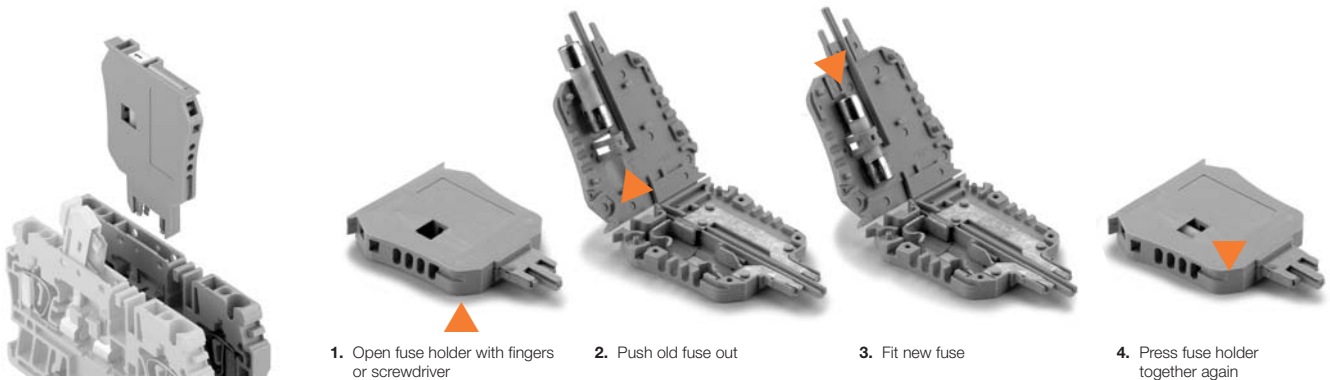

1. Open fuse holder with fingers or screwdriver
2. Push old fuse out
3. Fit new fuse
4. Press fuse holder together again

For G-fuse cartridges 5 x 20

The SIHA fuse holder turns a simple terminal into a fuse terminal in next-to-no time.

Simply remove the isolating lever and plug on the fuse plug.

- Simple handling – without tools
- Housing made of Wemid (V0)
- Rated current 6.3 A
- 1,6 W power loss to DIN VDE 0611-6 at 23°C ambient temperature (also for 1.5 times rated current – composite arrangement)
- Even fits on 5 mm wide terminals when fitted in offset arrangement
- Marking position for Dekafix 5 and space for self-adhesive label size 8/20



SIHA 1



	Qty	Order No.
without LED		
SIHA1/G20		
400 V	1	9537550000
with LED (red)		
SIHA1/G20		
10 - 36 V	1	9537560000
35 - 70 V	1	9537570000
60 - 150 V	1	9537580000
140 - 250 V	1	9537590000
for isolating terminal type		
WTR 2.5 ...		

SIHA 2



	Qty	Order No.
without LED		
SIHA2/G20		
400 V	1	9537600000
with LED (red)		
SIHA2/G20		
10 - 36 V	1	9537610000
35 - 70 V	1	9537620000
60 - 150 V	1	9537630000
140 - 250 V	1	9537640000
for isolating terminal type		
WTR 4 ...		

SIHA STRAP

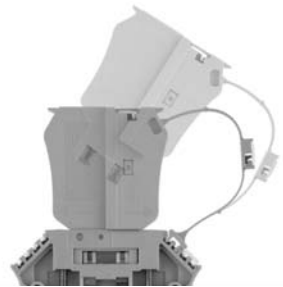

	Qty	Order No.
with strap		
SIHA STRAP		
	20	953768000

- Connector for subsequent assembly
- Receptacle in the terminal is the marking position
 - Integrated marking position
 - Clips into fuse holder either on the left or on the right

Accessories – Specific functions

Screen plug (LS)

A screen plug (LS) is available for many terminals in the W-series. The bar can be used to continue the shielding over the terminals as an interface. There is no direct connection to earth potential.

Assembly

The screen plug is placed flat in the bottom of the terminal in the recess provided. At the ends, the shield can be plugged in with a 2.8 mm push-on tab or also soldered on.

Reduced rated voltage

The smaller clearance and creepage sections result in a reduced voltage rating in the terminal when using the screen plug.

Shorting plug (WDS)

Shorting plugs (cross-connection plugs) are used together with sockets (diameter 2.3 mm) for easily disconnected cross-connection of terminals.

In practice, this plug is frequently used for isolating or measuring and isolating terminals. The insulated holder makes the WDS finger-safe.

Assembly

The plug is simply plugged onto the socket and locks automatically.

For terminal width 5.1 mm

Extension connector (WZAD)



An extension connector (WZAD) is offered for feed-through terminals from 50 mm²

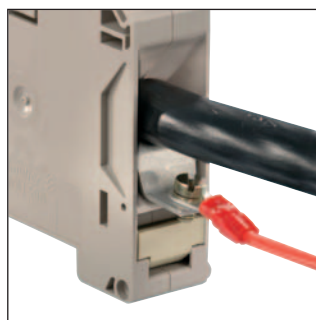

Assembly

This connector consists of a metal part which is pushed into the terminal and lodges behind the clamping yoke. The WZAD extension connector is connected to the "main" conductor in the terminal. Another conductor of up to 4 mm² and 32A can be screwed to the outer end of the extension connector using a ring cable lug.

Exception WZAD WDU 240

The extension connector for WDU 240 is separately plugged into the terminal above the wire entry and locks automatically. The conductor is connected with a fully insulated screw connection.

LS 2.8

Type	Qty	Order No.
LS 2.8 WDU2.5-10	50	1056400000

WDS

Type	Qty	Order No.
WDS 2	20	1069900000

WZAD

Type	Clamping conductor	Rated current	Qty	Order No.	for terminal
WZAD 70	up to 4 mm ²	32 A	10	1066000000	WDU 70/95
WZAD 120	up to 4 mm ²	32 A	10	1066100000	WDU 120/150
WZAD 240	up to 10 mm ²	57 A	5	1802810000	WDU 240
WZAD 70N	up to 4 mm ²	32 A	10	9512280000	WDU 50N/70N
WZAD 95N/120N	up to 4 mm ²	32 A	5	1859580000	WDU 95N/120N

Reduced voltage

for standard terminal	Reduced voltage
WDU 1.5/ZZ	400V
WDU 2.5/1.5/ZR	400V
WDU 2.5	400V
WDU 4	400V
WDU 6	400V
WDU 10	400V
WDK 2.5 ZQV	250V
WDK 2.5 (WQV)	250V
WTR 2.5...	250V

for compact terminal	Reduced voltage
WDK 2.5N	250V
WDK 4N	250V

for terminal
WDU 1.5/ZZ
WDU 2.5/1.5/ZR
WDU 2.5
WDK 2.5... (WQV)
WTR 2.5...
WDU 2.5 F...

Accessories – Specific functions

PEN bridges

Energy distribution for machines or in buildings usually consists of 5-conductor systems (TN-S). By contrast, energy supply mains are frequently rated as 4-conductor connection. A PEN bridge is used to split the joint PE and N conductor into 2 separate conductors, transforming the TN-S to a TN-C mains.

Standard installation

Depending on the terminal type, inside or outside PEN bridges are available for both PE and N conductor terminals from 10 mm².

Important! For outside bridges, please note that in this context only the next smaller rated cross-section (than standard) can be connected.

Building installation with N conductor isolation

There are special outside cross-connectors (WQB-PEN) for isolating neutral terminals (WNT) which establish the contact between NT and PE terminals. This results in an earthed neutral conductor with protection function in three-phase systems.

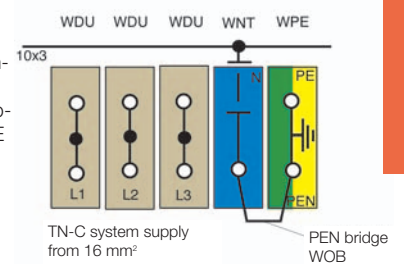

External PEN bridge



Inside PEN bridge

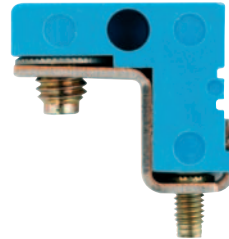

WQB-PEN ...

Type	Qty	Order No.	for terminal
with standard terminals			
WQB-PEN 10	10	1060300000	WPE 10 WDU 10 BL
WQB-PEN 16	10	1060200000	WPE 16 WDU 16 BL
WQB-PEN 3	10	1060100000	WPE 35N WDU 35N BL
with isolating neutral terminals			
WQB-PEN 16N	10	1079600000	WNT 16N WPE 16N
WQB-PEN 35N	10	1079500000	WNT 35N WPE 35B
WQB-PEN 70N	10	1079700000	WNT 70N WPE 70N

WQV ... -PEN

Type	Qty	Order No.	for terminal
WQV 16N-PEN	10	1071360000	WPE 16N WDU 16N BL
WQV 70N-PEN	5	9525840000	WPE 70N WDU 70N BL
WQV 70/95-PEN	5	1072300000	WPE 70/95 WDU 70/95 BL
WQV 120-PEN	5	1072400000	WPE 120/150 WDU 120/150 BL

Accessories – Specific functions

Accessories for measuring and isolating terminals

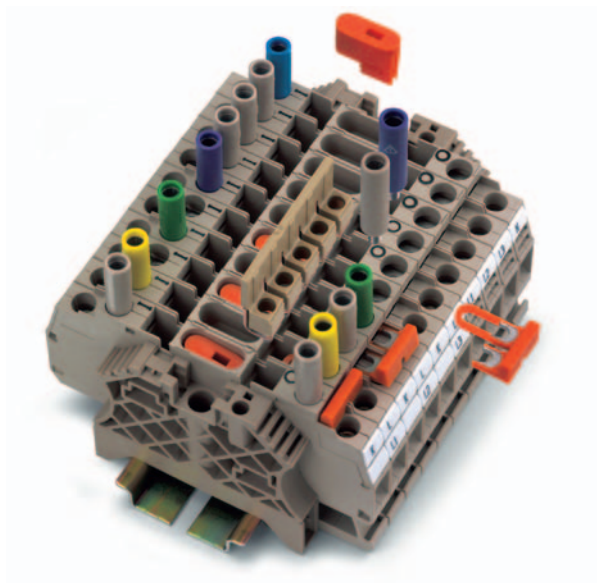

Cross-connection slider QVS ...

Connection sleeves VH 19 and fixing screws BS 25 (or sockets StB 35) are required for fastening the QVS in the individual terminals.

The fixing screws have an insulating sleeve as colour marking and a screw-driver guide. Cross-connection sliders are designed so that the sockets inserted in the terminals remain available for test plugs at every position. The 2-pole version type QVS 2S is designed to slide with test plugs plugged in. If the option of testing is required when the QVS is plugged in, socket StB35 can be used for fastening.

The clearance and creepage sections required for the rated voltage of the terminal are changed when accessories are fitted.

Sockets type StB are screwed into the busbar of the terminal. They take test plugs type PS4 or cross-connectors type QS2.

QVSK 2 (167036)

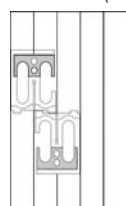

WTL6/1, WTD6/1

QVS 2 (030730)

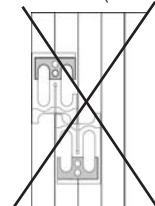

WTL6/1, WTD6/1

Note:

QVB 2 cannot be switched offset to each other.

Rated voltage

for neighbouring	rated voltage	for neighbouring	rated voltage
QVS	63 V	StB 25	63 V
WQV	bis 400 V	StB 30.5	63 V
QL	250 V	StB 35	63 V

To retain the rated voltage, partition plates TW or partition discs TSch have to be used, except with WQV.

SSP WTL, SSP 3 and **SSP 4** prevent unwanted opening or closing of current circuits. They block the disconnecting slider in its particular position. The lockout device is easily pressed into the terminal, but can only be removed again with a tool.

Type	Qty	Order No.
SSP 3	100	0531760000
SSP 4	20	1319360000
SSP WTL	100	1604200000

QVS 1

Cross-connection slider



QVS QVS QVSK 2 QVS 2S

Type	No. of poles	Qty	Order No.
QVS 2	2	20	0307300000
QVSK 2	2	20	1670360000
QVS 3	3	20	0329300000
QVS 4	4	20	0307400000
QVS 2S	2	20	0358460000

STB

Sockets



Type	Colour	Qty	Order No.
STB 14		50	0169900000
STB 25			
STB 25	yellow	50	0267200000
STB 25	green	50	0271200000
STB 25	violet	50	0271300000
STB 25	black	50	0271500000
STB 25	grey	50	0271400000
STB 25	blue	50	0343400000
STB 25	red	50	0343300000
STB 30.5			
STB 30.5	black	50	0341000000
STB 30.5	grey	50	0341100000
STB 30.5	blue	50	0341200000
STB 30.5	red	50	0341300000
STB 30.5	green	50	0341400000
STB 30.5	yellow	50	0341500000
STB 30.5	violet	50	0341600000
STB 35			
STB 35	yellow	50	0389000000
STB 35	green	50	0388900000
STB 35	violet	50	0389100000
STB 35	black	50	0388500000
STB 35	grey	50	0388600000
STB 35	blue	50	0388700000
STB 35	red	50	0388800000

Accessories – Specific functions

Accessories for measuring and isolating terminals

BS fixing screws

WH connecting sleeves

WQV cross-connectors

WQV cross-connectors allow for finger and hand-safe connection between neighbouring terminals in accordance with VBG 4.

QL cross-connection lug

Cross-connection lugs type QL are used in isolating terminals WLT 6.1 as fixed i. e. not switching cross-connector. They are fastened with connecting sleeves VH 12 and fixing screws BS M 3 x 20 (or sockets StB 30.5).

The clearance and creepage sections required for the rated voltage of the terminal can be changed when accessories are installed. This applies in particular to the cross-connection of neighbouring terminals of differing potential.

WKB

cross-connection bridge

WKB can be inserted from above in the case of cross-disconnect terminal type WTQ 6/1. The integrated disconnect slider is then responsible for connection or disconnection.

QS2 cross-connection plug

For sockets diameter 4 mm, for loads up to 44 A

BS / VH



Type	Colour	Qty	Order No.
Fixing screws			
BS 25	yellow	50	0335700000
BS 25	green	50	0335600000
BS 25	violet	50	0335800000
BS 25	grey	50	0335300000
BS 25	black	50	0335200000
BS 25	blue	50	0335400000
BS 25	red	50	0335500000
BS 25	plain	50	0334700000
BS M3 x 20		100	0377100000
CuNi 60 (copper alloy)			
Connecting sleeves			
VH 19		50	0318000000
CuZn 39 (brass alloy)			
VH 12		100	0249000000
E-Cu 57 (copper alloy)			

WQV / QL



WQV (only for WTL 6/2, WTL 6/3)

Type	No. of poles	Qty	Order No.
WQV			
WQV 6/2	2	50	1052360000
WQV 6/3	3	50	1054760000
WQV 6/4	4	50	1054860000
WQV 6/5	5	50	1062660000
WQV 6/7	7	50	1062680000
WQV 6/10	10	20	1052260000
QL			
QL 2	2	50	0194300000
QL 3	3	50	0194400000
QL 4	4	50	0194500000
QL 5	5	50	0220500000
QL 6	6	50	0220600000
QL 10	10	20	0338300000
QL 15	15	10	0221200000

WKB

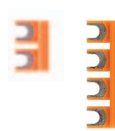

Type	No. of poles	Qty	Order No.
WQV			
WKB 1/2	2	50	1604280000
WKB 1/3	3	50	1604300000
WKB 1/4	4	50	1604320000
WKB 1/10	10	20	1604330000

QS 2



Type	No. of poles	Qty	Order No.
WQV			
QS 2	2	20	0270960000
x = 8 mm, y = 16 mm			
QS 2	2	20	0270860000
x = 10 mm, y = 20 mm			
QS 2	2	20	0270760000
x = 12 mm, y = 20 mm			

Colour-versions

Colour-versions

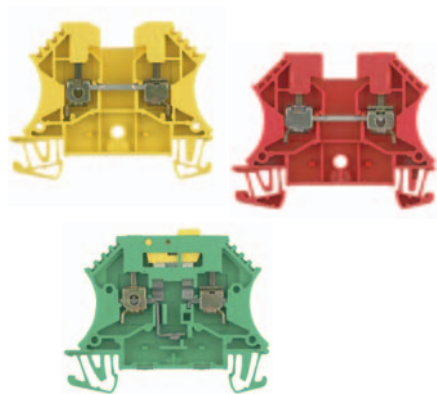

The colours listed are available as standard. Other terminal types can be supplied in customised colours on request for quantities exceeding the minimum quantity.

D

Standard design

WDU 2.5	Colour	Qty	Order No.
WDU 2.5 OR	orange		1020060000
WDU 2.5 BR	brown		1037710000
WDU 2.5 GE	yellow		1020020000
WDU 2.5 GN	green		1020090000
WDU 2.5 GR	grey		1037720000
WDU 2.5 RT	red		1020040000
WDU 2.5 SW	black		1020010000
WDU 2.5 VI	violet		1037700000
WDU 2.5 WS	white		1036800000
WDK 2.5			
WDK 2.5 OR	orange		1021560000
WDK 2.5 WS	white		1790900000
WDK 2.5 V			
WDK 2.5 V OR	orange		1022360000
WDK 2.5 V GE	yellow		1022350000
WDU 4			
WDU 4 OR	orange		1036760000
WDU 4 BR	brown		1037810000
WDU 4 GE	yellow		1020120000
WDU 4 GN	green		1020160000
WDU 4 GR	grey		1037800000
WDU 4 RT	red		1020140000
WDU 4 SW	black		1020110000
WDU 4 VI	violet		1037820000
WDU 4 WS	white		1036700000
WDU 6			
WDU 6 OR	orange		1020260000
WDU 6 GE	yellow		1040220000
WDU 6 GR	grey		1039600000
WDU 6 RT	red		1020240000
WDU 6 SW	black		1020210000
WDU 6 WS	white		1039700000
WDU 10			
WDU 10 OR	orange		1020360000
WDU 10 GR	grey		1020320000
WDU 10 RT	red		1020340000
WDU 16			
WDU 16 OR	orange		1020460000
WTR 2.5			
WTR 2.5 OR	orange		1011160000
WTR 2.5 GE	yellow		1011120000
WTR 2.5 GN	green		1011130000
WTR 2.5 GR	grey		1011150000
WTR 2.5 RT	red		1011140000
WTR 2.5 SW	black		1011110000
WTR 2.5 WS	white		1011190000
WTR 4			
WTR 4 SW	black		7910200000
WTR 4 StB			
WTR 4 StB SW	black		7910230000
WSI 6			
WSI 6 OR	orange		1011060000
WSI 6 SW	black		1011010000
WTD 6/1			
WTD 6/1 GE	yellow		1631760000
WTD 6/1 GR	grey		1017120000
WTD 6/1 RT	red		1631750000
WTD 6/1 SW	black		1631770000
WTQ 6/1			
WTQ 6/1 GE	yellow		1847660000
WTL 6/3			
WTL 6/3 BR	brown		1018640000
WTL 6/3 GR	green		1018850000

Compact design

WDU 2.5N	Colour	Qty	Order No.
WDU 2.5N OR	orange		1023760000
WDU 2.5N GE	yellow		1023790000
WDK 2.5N			
WDK 2.5N OR	orange		1041660000
WDK 4N			
WDK 4N OR	orange		1041960000

Terminal blocks

Pre-fitted terminal blocks

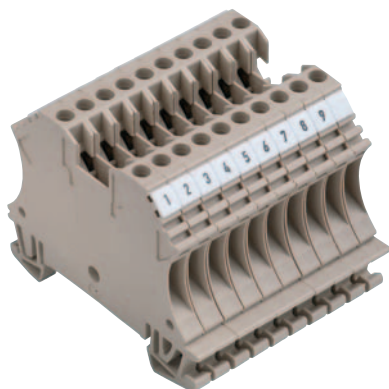

Ready assembled and marked terminal blocks are available as a standard feature for smaller cross-section ranges.

Installation times can be reduced by simply slotting on complete blocks. The rating data depend on the corresponding terminal type.

Important!

- Tolerances for butt mounting must be heeded in project planning. A butt mounting tolerance of +0.1 mm must be expected for each terminal.
- In terminal blocks marked 1 – 9, the 10th terminal is free for decade marking.
- Terminal blocks WDU 70/95 and WDU 120/150 for direct mounting only.

For direct mounting without the mounting rail please take notice of the drilling plan.

Fixing with screw M6x16.
(Order No. 1063700000/ Qty. 20)

Drilling plan WDU 70/95

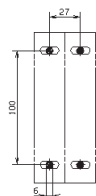

Drilling plan 120/150

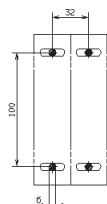

Standard design

Standard design	Qty	Order No.	Description
WDU 2.5			
WDU 2.5/10 BEZ	10	1020700000	10x WDU 2.5, identified by printed marking strip DEK 5 (nos. 1 – 9)
WDU 2.5/10/ZA BEZ 1-10	10	1033410000	10x WDE 2.5, identified by printed marking strip DEK 5 (nos. 1 – 10)
WDU 2.5/10 BEZ/NE	10	1020800000	10 x WDE 2.5, with neutral marking strip DE 4
WDK 2.5			
WDK 2.5/10/BEZ	10	1025600000	10x WDK 2.5 (WQV), identified by printed marking strip DEK 5 (nos. 1 – 9)
WDK 2.5/10	10	1025700000	10 x WDK 2.5 (WQV), with neutral marking strip DEK 5
WDK 2.5 ZQV/10/BEZ	10	1025610000	10 x WDK 2.5 (ZQV), identified by printed marking strip DEK (fig. 1-9)
WDU 4			
WDU 4/10/BEZ	10	1020900000	10x WDU 4, identified by printed marking strip DEK 6 (figs. 1-9)
WDU 4/10	10	1021000000	10 x WDU 4 identified by neutral marking strip DEK 6
WMA 4/4	20	1034000000	3x WDU 4 (marked L1, L2, L3), WPE 4 (marked PE)
WMA 4/5	20	1033800000	3x WDU 4 (marked L1,L2,L3), DEU 4 in blue (identified by N), WPE 4 (marked PE)
WDU 6			
WDU 6/10 BEZ	10	1021400000	10x WDU 6, identified by printed marking strip DEK 8 (figs. 1-9)
WDU 6/10 BEZ/NE	10	1021300000	10x WDU 6 identified by neutral marking strip DEK 8
WDU 70/95			
WDU 70/95/3	4	1026700000	3 x WDU 70/95
WDU 70/95/4	3	1026800000	4 x WDU 70/95
WDU 70/95/5	2	1026900000	5 x WDU 70/95
WDU 70/95/5/N	2	1032300000	mains terminal block, 3x WDU 70/95 dark beige, 1x WDU 70/95 blue, 1x WDU 70/95 green
WDU 120/150			
WDU 120/150/3	3	1026400000	3 x WDU 120/150
WDU 120/150/4	2	1026500000	4 x WDU 120/150
WDU 120/150/5	2	1026500000	5 x WDU 120/150
WDU 120/150/5/N	2	1032400000	mains terminal block, 3x WDU 120/150 dark beige, 1x WDU 120/150 blue, 1x WDU 120/150 green
WDL 2.5			
WDL 2.5/3/S/NT/L/PE	25	1034200000	3x WDL 2.5/S/NT/L/PE
WDL 2.5/2/NT/L/PE-L/L	20	1034100000	WDL 2.5/S/NT/L/PE and WDL 2.5/S/L/L
DLI 2.5			
DLI 2.5/10 DB	10	1783850000	10 x DLI 2.5DB, the bottom two levels each cross-connected, no marking tabs
DLI 2.5/10/BEZ +- DB	10	1783830000	10x DLI 2.5 DB, the bottom two levels each cross-connected, identified by +/-
DLA 2.5 DB			
DLA 2.5/10 DB	10	1783570000	10x DLA 2.5 DB, the two bottom levels each cross-connected, no marking tabs
DLA 2.5/10/BEZ DB	10	1783580000	10x DLA 2.5 DB, the two bottom levels each cross-connected, identified by -/PE
AKZ 1.5			
AKZ 1.5/10	10	0358060000	10x AKZ 1.5
AKZ 1.5/10/BEZ	10	0358160000	10x AKZ 1.5, identified by printed marking strip DEK 5 (nos. 1-9)
AKZ 4			
AKZ 4/10	10	0359560000	10x AKZ 4
AKZ 4/10/BEZ	10	0359660000	10x AKZ 4, identified by printed marking strips DEK 5 (nos. 1-9)
Compact design			
WDU 2.5N			
WDU 2.5N/10 BEZ/NE	10	1024800000	10x WDU 2.5N, identified by printed marking strips DEK5 (nos. 1-9)
WDU 2.5N/10 BEZ	10	1024900000	10x WDU 2.5N, identified by neutral marking strip DEK5
WDK 2.5N			
WDK 2.5N/10 (0-9)	10	1041700000	10x WDK 2.5N, identified by printed marking strip DEK5 (nos. 1-9)
WDK 2.5N/10	10	1041800000	10x WDK 2.5N, identified by neutral marking strip DEK5
WDK 4N			
WDK 4N/10 (0-9)	10	1042000000	10x WDK 4N, identified by printed marking strip DEK6 (nos. 1-9)
WDK 4N/10	10	1042100000	10x WDK4N, identified by neutral marking strip DEK6

SAK series

The SAK series lives on ...

... there's new product information on the core range of the SAK family!

Weidmüller supports all customers of the SAK family. The new print material is the SAK product information and two information brochures on specific subjects.

Screw connection – SAK series

Order number:

5634640000 SAK D

5634650000 SAK GB

5635020000 SAK E

SAK conductor connectors – synonymous with reliable connections and product variety.

Many years of market experience have resulted in a constant stream of new improvements. No terminal in the world embodies such know-how as the SAK.

Thus, the unassuming insulated unit with “clamping function” for the conductor conceals a wealth of sound knowledge and broad experience. For terminals have to cope with a wide variety of adverse conditions on a daily basis. The connection systems are chosen according to the application in question.

As well as connecting conductors, terminals also perform other functions: when provided with marking tags, the terminals are responsible for clear organisation of the electrical system. In addition, they form a defined connecting point that can be arranged in any order – a starting point for cables and conductors leading to the individual items of equipment in the switchgear cabinet or out of the switchgear cabinet altogether. Terminals make switchgear easier to service and maintain because they can be used for electrical measurements, for splitting up specific electrical circuits or protecting these with corresponding elements. In addition, cross connectors may be used, to distribute potential.

D



Energy supply and energy generation,
transducer isolating terminals and
nuclear power station terminals

Order number:

5622400000 D

5622410000 GB

Terminals – pilot protection
Order number:

5628310000 GB

Advantages of all SAK terminals:

- Separation of electrical and mechanical function:
 - Screw or tension clamp for mechanical function
 - Copper busbar for electrical function
- Maintenance-free, shock and vibration resistant, screw technology
- Low voltage drop, gas tight contact point
- High clamping point regardless of cross-section
- Three different clip-in feet available
- Various insulation materials
- Wide range of special terminals with different connecting techniques
- Wide range of accessories

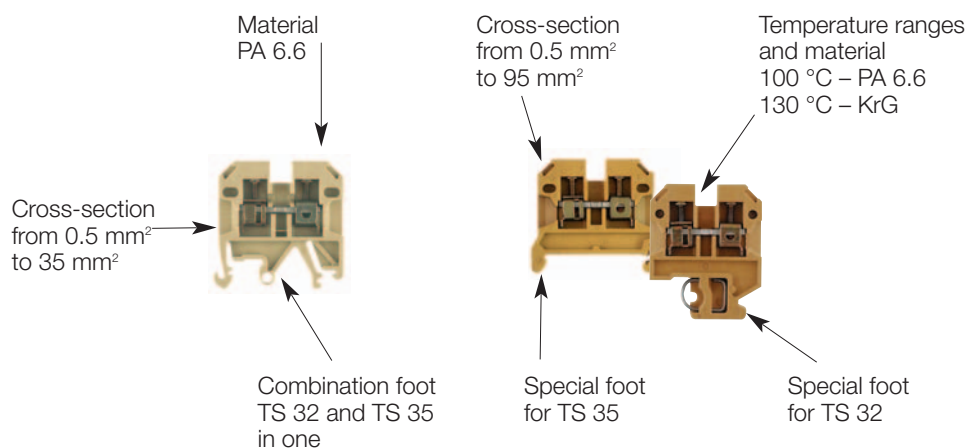
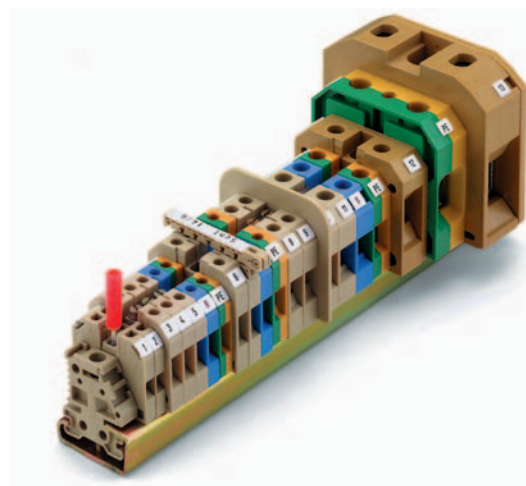

Product range

Terminal type	Rated cross-section						Flat connection	Flat plug-in connection	Spring loaded	Soldered connection
	2.5 mm ²	4 mm ²	6 mm ²	10 mm ²	16 mm ²	35 mm ²				
Feed-through terminals										
PA 6.6 / TS 32	•	•	•	•	•	•		•	•	•
KrG / TS 32	•	•	•	•	•	•	•	•	•	•
PA 6.6 / TS 35	•	•	•	•	•	•		•	•	•
KrG / TS 35	•	•	•	•	•	•	•			
PA 6.6 / combination foot	•	•	•	•	•	•				
PA 6.6 / TS 15	•	•						•		•
Double-decker terminals										
PE terminals										
PA 6.6 / TS 32	•	•		•	•	•				
PA 6.6 / TS 35	•	•	•	•	•	•				
PA 6.6 / TS 15	•	•								
Fuse terminals										
PA 6.6 / TS 32				•						
PA 6.6 / TS 35				•						
KrG / TS 32				•	•					
KrG / TS 35				•	•					
PA 6.6 / TS 15		•								
PA 6.6 / combination foot		•								
Double-decker fuse terminals										
PA 6.6 / TS 32		•								
PA 6.6 / TS 35		•								
Combination foot		•								
Isolating terminals										
TS 35		•		•						
PA 6.6 / TS 15		•								
Double-decker isolating terminals		•						•		
Ceramic terminals		•		•						

Overview

Stud terminals

Power transmission

Weidmüller's extensive range of stud terminals offers secure connections for all applications which entail a transmission of energy.

The connection range extends from 10 mm² to 300 mm².

The conductors are applied to the threaded studs by means of crimped cable lugs, and then securely connected by tightening the hex nut.

Stud terminals can be used with threaded studs M5 to M16, depending on the conductor cross section.

Maximum safety is guaranteed by low voltage loss and self-extinguishing material in flammability class V-0 (UL94).

All stud terminals are tested according to international railway standards (EN 50343, EN 50155, NF F61-017, NF16-101, RIA 20) and comply with these requirements.

Handling

To connect the conductors, cable lugs are crimped to the ends of the conductors. The cable lugs are placed on the stud between the washer on the terminal carrier and toothed washer. The backs of the cable lugs lie against each other. The hex nuts are tightened to press the lugs of the cable lugs against each other for secure contact.

In addition, a third conductor can be positioned from the opposite connection direction.

Accessories

We also offer extensive accessories for our stud terminals, with detailed descriptions on the following pages.

Series WF/WFF

- for voltage ranges up to 1000 V
- also suitable for up to 2300 V and 520 A when using special epoxy resin partition plates

Single stud terminals WF

- 4 conductors can be securely connected without any problems
- 3 conductors even without restricting the rating data

Two-stud terminals WFF

- integrated hinged head

Series ST 400

- for voltage ranges up to 4000 V and currents up to 415 A
- for extreme demands, particularly in railway applications

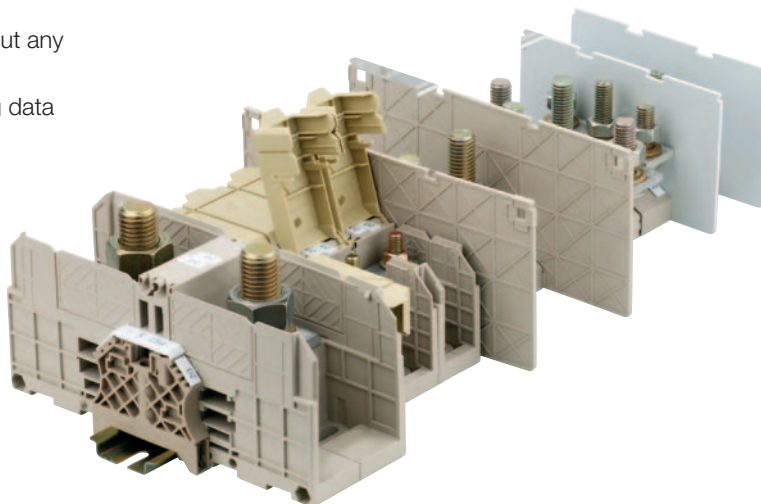

Product overview

Thread size	M5	M6	M8	M10	M12	M16
Single stud terminals – WF	•	•	•	•	•	
Two-stud terminals – WF 2 BZ		•	•	•		
Two-stud terminals – WFF		•	•	•	•	•
Two-stud terminals – ST 4000 (up to 4000 V)		•	•	•		

In detail

Stud connection

- Stud size M5 to M16
- Conductor with cable lug acc. to DIN 46234 up to 240 mm² acc. to DIN 46235 up to 300 mm²
- 3 cable lugs possible per stud



Cross connections

- Faster electrical distribution for clear time savings
- Can be used for all stud terminals
- Available in 2, 3 and 4-poles version
- Electrical distribution possible between different sizes (from WF6 to WF8 and to WF10)

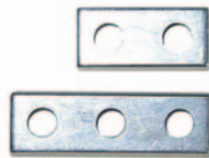

Simple handling

- Cable lugs placed on the stud
- Washer and toothed washer placed on top
- Steel nut tightened to create contact between cable lugs and possibly bus bar

Wemid clamped support

- Tracking resistance CTI 600
- Temperature resistant 120°C
- Self-extinguishing VO acc. to UL94
- Free of pollutants

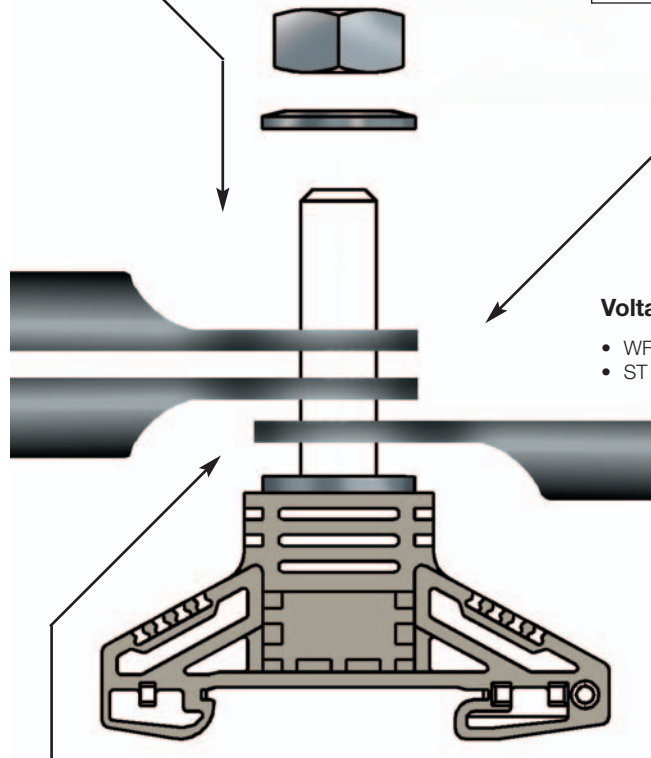

Voltage range

- WF / WFF up to 2300 V
- ST 4000 up to 4000 V

Safe contact

- Maintenance free, no need to tighten the nuts
- Toothed washer for vibration-proof, high-strength contact
- Cable lugs contact directly or via a highly conductive busbar



Safe handling

Shock protection

- In WF with partitions and transparent cover profiles
- In WFF with locking cover for each connection
- In ST 4000 with screw-on polycarbonate cover

Standards

Fulfil requirements for standard terminals and specific railway standards

- EN 60 947-7-1
- EN 50124-1
- DIN EN 61373
- RIA 20
- EN 50343
- NF F 61-017

Stud terminals – accessories

Series WF and WFF

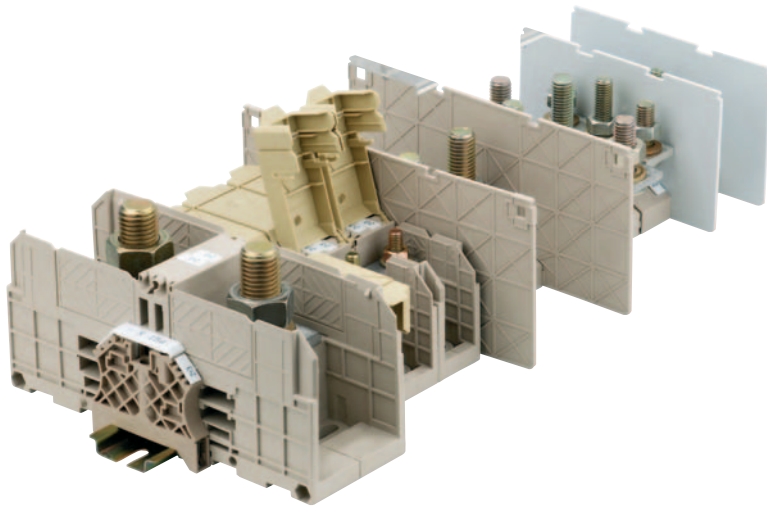

Electrical distribution



Electrical distribution can be realised between neighbouring stud terminals easily with 2- and 3-poles cross-connections. Cross-connections are also available for different thread sizes from M6 to M8 or M10.

In the WFF two-stud terminals, firstly the flashes have to be removed between the clamped supports. The thin web of material means they can be broken out easily to fit.

Shock protection

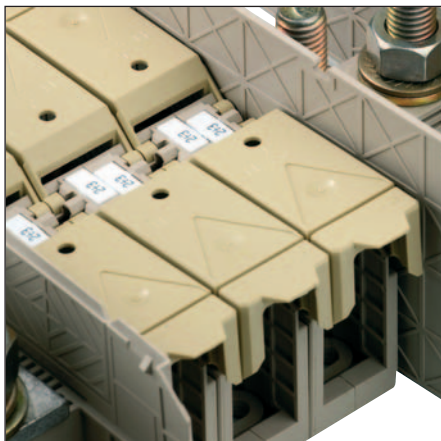

The two-stud terminals in the WFF series offer with an integrated hinged cover a high degree of finger safety.

When closed, the cover locks onto the terminal and protects the contact from external influences.

Shock protection / partition plates

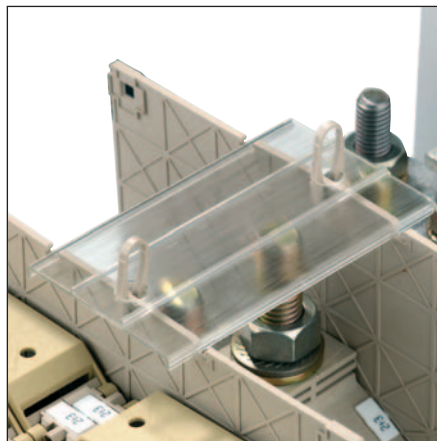

Shock protection in the WF series is provided by partition plates and transparent cover profiles. The cover profiles are locked into the guides of the partition plates and held with clips to prevent them slipping to the side.

Partition plates ensure compliance with the rated voltage:

- Voltage range up to 1000 V with partition plate WTW WF
- Voltage range up to 2300 V for WF with epoxy partition plate WTW WF 2300

Connection

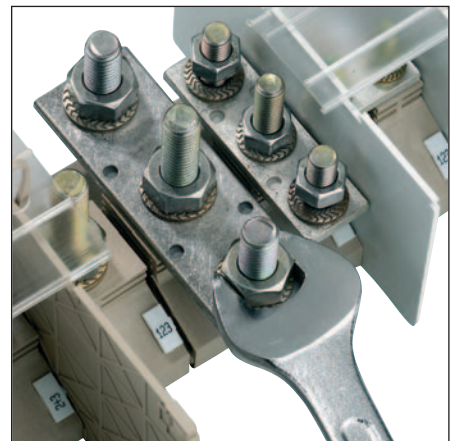

Can't be easier:

The cable lugs are placed on the stud with the washer and toothed washer on top. A normal open-ended spanner can be used to tighten the hex screw and complete installation.

Stud terminals – accessories

Series ST 4000

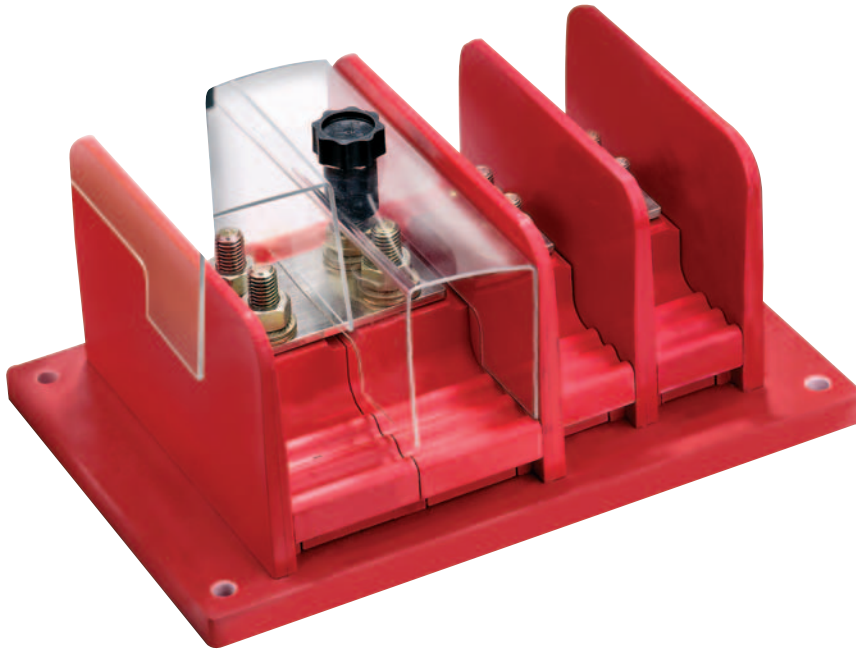

Shock protection



Stud terminals in the ST 4000 series offer an ideal cover for every version. The polycarbonate cover is placed between the partition walls and fastened to the stud with the plastic-coated fixing nut. Fixing nuts are available to fit every stud size.

Electrical distribution



When two neighbouring ST 4000 terminals have the same potential, cross connectors are fitted instead of the busbar. The pairs of holes in the cross connection are rated exactly to the spacing of ST 4000. Here the partition plate has to be replaced by the connecting piece ST 4000/S C130 or ST 4000/L C160.

Cross connectors are available as 2, 3 or 4-poles.

Connection



Can't be easier:
The cable lugs are placed on the stud with the washer and toothed washer on top. Tighten the steel hexagonal nut to ensure good contact between cable lug and busbar. The same principle applies when two cable lugs contact on one stud or slotted hole cable lugs are used. Slotted hole cable lugs can also be placed over both studs.

1-stud terminals

WF-Series

WF 5

16 mm²

WF 6

35 mm²

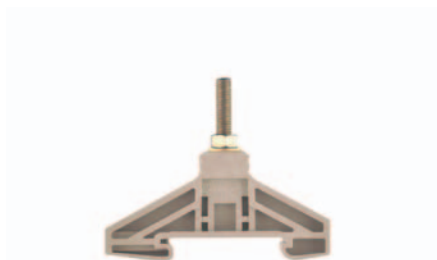

When using ATEX certified components in hazardous area applications the installation instructions and the rated data for accessories in the technical appendix must be considered.

Width/Length/Height with TS35x7.5	mm
Max. current / max. cond. cross-section	A/mm ²
Max. clamping range	mm ²

13 x 67 x 54
76 / 16
0.1... 16

19.6 x 67 x 56
125 / 35
2.5... 35

Technical data

Rated data w. partition, Wemid	
Rated voltage	V
Rated current	A
Rated cross-section	mm ²
Rated impulse voltage / Pollution severity	kV/-
Plug gauge IEC 60-947-1 / flammability class acc. UL94	
Approvals	

IEC	UL	CSA	EN 50019
1000	1000	1000	
76	115	85	
16	AWG 10 ...5	AWG 10...4	
		8 / 3	
		/ V-0	

IEC	UL	CSA	EN 50019
1000	1000	1000	
125	115	150	
35	AWG 14 ...2	AWG 14...2	
		8 / 3	
		/ V-0	

Rated data w. partition, Epoxy resin	
Rated voltage / Rated impulse voltage	V/kV

EN 50124

EN 50124

Cable lugs, clamp.	
DIN 46234 / 1 cable lug per side	mm ²
DIN 46234 / 2 cable lugs per side	mm ²
DIN 46235 / 1 cable lug per side	mm ²
DIN 46235 / 2 cable lugs per side	mm ²
Tightening torque range	Nm

0.1...16
0.1...16
6...10
6...10
2.0

2.5...35
2.5...35
6...35
6...25
3.0...6.0

Information

Ordering data

Version	
	dark beige Wemid
	blue Wemid
Version w. mounted hood	dark beige Wemid

Type	Qty.	Order No.
WF 5	25	1790130000

Type	Qty.	Order No.
WF 6	25	1780850000

Information

Accessories

Cross-connection		
WQL	2-pole	
	3-pole	

Type	Current [A]	Qty.	Order No.
WQL 2 WF5	76	5	1812710000
WQL 3 WF5	76	5	1812740000

Type	Current [A]	Qty.	Order No.
WQL 2 WF6 - t=4mm	125	5	1780970000
WQL 3 WF6 - t=4mm	125	5	1780980000

Partition	
up to 1000V	dark beige Wemid
up to 1000V f. insul. cable lugs	dark beige Wemid
up to 2300V	beige epoxy resin

Width [mm]			
WTW WF6-WF12	2.5	20	1781240000

Width [mm]			
WTW WF6	2	20	1781220000
WTW WF6-WF12	2.5	20	1781240000
WTW WF6 2300	2	20	1781230000

End bracket	
	dark beige Wemid

Width [mm]			
WEW-35/2	8	100	1061200000

Width [mm]			
WEW-35/2	8	100	1061200000

Shock protection	
Cover profile, transparent	
Holder for cover profile, transp.	
Hood, dark beige, Wemid	

ADP WF6/WF8	20	1780930000
HA ADP WF6/WF10	10	1781050000

ADP WF6/WF8	20	1780930000
HA ADP WF6/WF10	10	1781050000

Warning triangle for power supply terminals	
	With elec. shock warn. symbol

Marking systems (see large assortment in chapter M)	
	Tags

WS 12/5

WS 10/5 / WS 10/6

For detailed information on additional accessories and usage instructions see chapter accessories.

With WTW...2300 made of epoxy resin, rated current 2.300V acc. to EN 50124-1

With WTW...2300 made of epoxy resin, rated current 2.300V acc. to EN 50124-1

1-stud terminals

WF 8

50 mm²



24.6 x 67 x 65
150 / 50
2.5... 50

IEC	UL	CSA	EN 50019
1000	1000	1000	
150	150	150	
50	AWG 14 ...1/0	AWG 14...1/0	
	8 / 3		
	/ V-0		



EN 50124

2.5...50
2.5...50
6...35
6...35
6.0...12

Type	Qty.	Order No.
WF 8	25	1780860000

Type	Current [A]	Qty.	Order No.
WQL 2 WF6-8 - t=4mm	150	5	1808980000
WQL 3 WF8 - t=4mm	150	5	1781000000

Width [mm]

Type	Width [mm]	Qty.	Order No.
WTW WF8	2	20	1780900000
WTW WF6-WF12	2.5	20	1781240000
WTW WF8 2300	2	20	1780910000

Width [mm]

Type	Width [mm]	Qty.	Order No.
WEW-35/2	8	100	1061200000

Type	Qty.	Order No.
ADP WF6/WF8	20	1780930000
HA ADP WF6/WF10	10	1781050000

WS 10/5 / WS 10/6

With WTW...2300 made of epoxy resin, rated current 2.300V acc. to EN 50124-1

WF 10

120 mm²



35.6 x 67 x 74
269 / 120
6... 120

IEC	UL	CSA	EN 50019
1000	1000	1000	
269	255	255	
120	AWG 10 ...250 kcmil	AWG 10...250 kcmil	
	8 / 3		
	/ V-0		



EN 50124

6...120
6...120
10...95
10...95
10...20

Type	Qty.	Order No.
WF 10	20	1780870000

Type	Current [A]	Qty.	Order No.
WQL 2 WF6-10	269	5	1806620000
WQL 3 WF6-10/2	269	5	1806640000

Width [mm]

Type	Width [mm]	Qty.	Order No.
WTW WF10/WF12	2	20	1780890000
WTW WF6-WF12	2.5	20	1781240000
WTW WF10/WF12 2300	2	20	1780920000

Width [mm]

Type	Width [mm]	Qty.	Order No.
WEW-35/2	8	100	1061200000

Type	Qty.	Order No.
ADP WF10/WF12	20	1780940000
HA ADP WF6/WF10	10	1781050000

WS 10/5 / WS 10/6

With WTW...2300 made of epoxy resin, rated current 2.300V acc. to EN 50124-1

WF 12

120 mm²

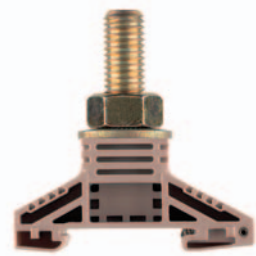

35.6 x 67 x 72
269 / 120
6... 120

IEC	UL	CSA	EN 50019
1000	1000	1000	
269	255	320	
120	AWG 10 ...250 kcmil	AWG 10...250 kcmil	
	8 / 3		
	/ V-0		



EN 50124

6...120
6...120
10...95
10...95
14...31

Type	Qty.	Order No.
WF 12	20	1780880000

Type	Current [A]	Qty.	Order No.
WQL 2 WF12	269	5	1781030000
WQL 3 WF12	269	5	1781040000

Width [mm]

Type	Width [mm]	Qty.	Order No.
WTW WF10/WF12	2	20	1780890000
WTW WF6-WF12	2.5	20	1781240000
WTW WF10/WF12 2300	2	20	1780920000

Width [mm]

Type	Width [mm]	Qty.	Order No.
WEW-35/2	8	100	1061200000

Type	Qty.	Order No.
ADP WF10/WF12	20	1780940000
HA ADP WF6/WF10	10	1781050000

WS 10/5 / WS 10/6

With WTW...2300 made of epoxy resin, rated current 2.300V acc. to EN 50124-1

2-stud terminals

WF 2BZ

When using ATEX certified components in hazardous area applications the installation instructions and the rated data for accessories in the technical appendix must be considered.

Width/Length/Height with TS35x7.5	mm
Max. current / max. cond. cross-section	A/mm ²
Max. clamping range	mm ²

Technical data

Rated data w. partition, Wemid

Rated voltage	V
Rated current	A
Rated cross-section	mm ²
Rated impulse voltage / Pollution severity	kV/-
Plug gauge IEC 60-947-1 / flammability class acc. UL94	
Approvals	

Rated data w. partition, Epoxy resin

Rated voltage / Rated impulse voltage	V/kV
---------------------------------------	------

Cable lugs, clamp.

DIN 46234 / 1 cable lug per side	mm ²
DIN 46234 / 2 cable lugs per side	mm ²
DIN 46235 / 1 cable lug per side	mm ²
DIN 46235 / 2 cable lugs per side	mm ²
Tightening torque range	Nm

Information

Ordering data

Version

dark beige Wemid	
blue Wemid	
Version w. mounted hood	dark beige Wemid

Information

Accessories

Cross-connection

WQL	2-pole	
	3-pole	

Partition

up to 1000V	dark beige Wemid
up to 1000V f. insul. cable lugs	dark beige Wemid
up to 2300V	beige epoxy resin

End bracket

dark beige Wemid	
------------------	--

Shock protection

Cover profile, transparent	
Holder for cover profile, transp.	
Hood, dark beige, Wemid	

Warning triangle for power supply terminals

With elec. shock warn. symbol	
-------------------------------	--

Marking systems (see large assortment in chapter M)

Tags	
------	--

For detailed information on additional accessories and usage instructions see chapter accessories.

WF 6/2BZ

35 mm²

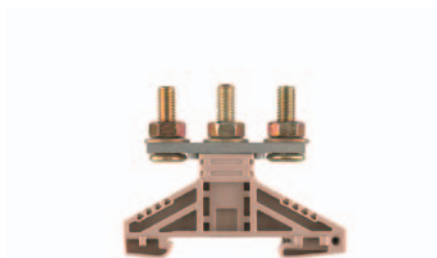

19.6 x 67 x 56
125 / 35
2.5... 35

IEC	UL	CSA	EN 50019
1000	1000	1000	
125	115	115	
35	AWG 14 ...2	AWG 14...2	
		8 / 3	
		/ V-0	



EN 50124

2.5...35
2.5...35
6...25
6...25
3.0...6.0

Type	Qty.	Order No.
WF 6/2BZ - t=4mm	25	1789770000

Type	Current [A]	Qty.	Order No.
WQL 2 WF6 - t=4mm	125	5	1780970000
WQL 3 WF6 - t=4mm	125	5	1780980000

Width [mm]		Qty.	Order No.
WTW WF10/WF12	2	20	1780890000

Width [mm]		Qty.	Order No.
WEW-35/2	8	100	1061200000

		Qty.	Order No.
ADP WF10/WF12	20	1780940000	
HA ADP WF6/WF10	10	1781050000	

WS 10/5 / WS 12/5

WF 8/2BZ

50 mm²

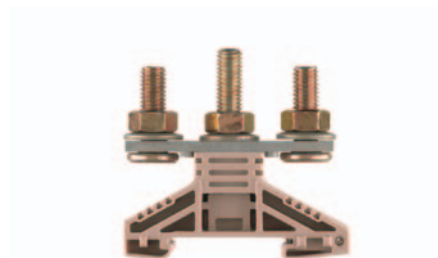

24.6 x 67 x 65
150 / 50
2.5... 50

IEC	UL	CSA	EN 50019
1000	1000	1000	
150	150	150	
50	AWG 14 ...1/0	AWG 14...1/0	
		8 / 3	
		/ V-0	



EN 50124

2.5...50
2.5...50
6...35
6...35
6.0...12

Type	Qty.	Order No.
WF 8/2BZ - t=4mm	25	1789780000

Type	Current [A]	Qty.	Order No.
WQL 2 WF8 - t=4mm	150	5	1780990000
WQL 3 WF8 - t=4mm	150	5	1781000000

Width [mm]		Qty.	Order No.
WTW WF10/WF12	2	20	1780890000

Width [mm]		Qty.	Order No.
WEW-35/2	8	100	1061200000

		Qty.	Order No.
ADP WF10/WF12	20	1780940000	
HA ADP WF6/WF10	10	1781050000	

WS 10/5 / WS 12/5

2-stud terminals

WF 10/2BZ

120 mm²

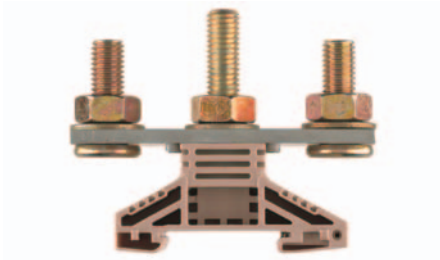

35.6 x 67 x 74

269 / 120

6... 120



IEC	UL	CSA	EN 50019
1000	1000	1000	
269	230	230	
120	AWG 10 ...250 kcmil		AWG 10...250 kcmil
	8 / 3		
			/ V-0



EN 50124

6...120

6...120

10...95

10...95

10...20

Type	Qty.	Order No.
WF 10/2BZ	20	1789790000

Type	Current [A]	Qty.	Order No.
WQL 2 WF10	269	5	1781010000
WQL 3 WF10	269	5	1781020000

Width [mm]			
WTW WF10/WF12	2	20	1780890000

Width [mm]			
WEW-35/2	8	100	1061200000

ADP WF10/WF12	20	1780940000
HA ADP WF6/WF10	10	1781050000

WS 10/5 / WS 12/5

With WTW...2300 made of epoxy resin, rated current 1.500V up to 70 mm² acc. to EN 50124-1

Articles with coloured order number are kept permanently in stock at the central warehouse in Germany. Delivery times see page X.2

2-stud terminals

WFF-Series

When using ATEX certified components in hazardous area applications the installation instructions and the rated data for accessories in the technical appendix must be considered.

Width/Length/Height with TS35x7.5	mm
Max. current / max. cond. cross-section	A/mm ²
Max. clamping range	mm ²

Technical data

Rated data w. partition, Wemid

Rated voltage	V
Rated current	A
Rated cross-section	mm ²
Rated impulse voltage / Pollution severity	kV/-
Plug gauge IEC 60-947-1 / flammability class acc. UL94	
Approvals	

Rated data w. partition, Epoxy resin

Rated voltage / Rated impulse voltage	V/kV
---------------------------------------	------

Cable lugs, clamp.

DIN 46234 / 1 cable lug per side	mm ²
DIN 46234 / 2 cable lugs per side	mm ²
DIN 46235 / 1 cable lug per side	mm ²
DIN 46235 / 2 cable lugs per side	mm ²
Tightening torque range	Nm

Information

Ordering data

Version	
	dark beige Wemid
	blue Wemid
Version w. mounted hood	dark beige Wemid

Information

Accessories

Cross-connection

WQL	2-pole
	3-pole

Partition

up to 1000V	dark beige Wemid
up to 1000V f. insul. cable lugs	dark beige Wemid
up to 2300V	beige epoxy resin

End bracket

dark beige Wemid

Shock protection

Cover profile, transparent
Holder for cover profile, transp.
Hood, dark beige, Wemid

Warning triangle for power supply terminals

With elec. shock warn. symbol

Marking systems (see large assortment in chapter M)

Tags

For detailed information on additional accessories and usage instructions see chapter accessories.

WFF 35

35 mm²

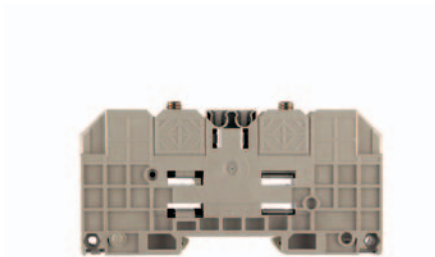

27 x 107 x 54,5
150 / 50
2.5... 50

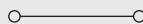

EEx e II T II 2 G D

IEC	UL	CSA	EN 50019
1000	1000	600	1100
125	115	130	109
35	AWG 14 ...2	AWG 14...2	35
8 / 3			
/ V-0			

KEMA 98ATEX1684 U

EN 50124

2.5...50
2.5...35
6...25
6...25
3.0...6.0

Auxiliary connection available up to 4mm²/32A (see section accessories).

Type	Qty.	Order No.
WFF 35	10	1028300000
WFF 35 BL	10	1028380000
WFF 35/AH	10	1029300000

Type	Current [A]	Qty.	Order No.
WQL 2 WFF35	125	5	1064900000
WQL 3 WFF35	125	5	1065400000

Width [mm]

WTW WFF35	2	10	1067100000
-----------	---	----	-------------------

Width [mm]

WEW 35/1	12.2	50	1059000000
----------	------	----	-------------------

WD 1 25 K KARTE A 6 ST	5	1563900000
------------------------	---	-------------------

WS 12/6,5

At the unused contact points, the cover plate WAP is used together with the hood WAH.

WFF 70

70 mm²



32 x 132 x 64
232 / 95
2.5... 95

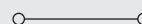

EEx e II T II 2 G D

IEC	UL	CSA	EN 50019
1000	1000	600	1100
192	175	170	167
70	AWG 14 ...2/0	AWG 14...2/0	70
8 / 3			
/ V-0			

KEMA 98ATEX1684 U

EN 50124

2.5...95
2.5...70
16...70
16...70
6.0...12

Auxiliary connection available up to 4mm²/32A (see section accessories).

Type	Qty.	Order No.
WFF 70	10	1028400000
WFF 70 BL	10	1028480000
WFF 70/AH	10	1029400000

Type	Current [A]	Qty.	Order No.
WQL 2 WFF70	192	5	1065000000
WQL 3 WFF70	192	5	1065500000

Width [mm]

WTW WFF70	2	10	1067200000
-----------	---	----	-------------------

Width [mm]

WEW 35/1	12.2	50	1059000000
----------	------	----	-------------------

WD 1 25 K KARTE A 6 ST	5	1563900000
------------------------	---	-------------------

WS 12/6,5

At the unused contact points, the cover plate WAP is used together with the hood WAH.

2-stud terminals

WFF 120

120 mm²

WFF 185

185 mm²

WFF 300

300 mm²



42 x 132 x 73
309 / 150
6... 150

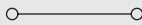

EEx e II T II 2 G D

IEC	UL	CSA	EN 50019
1000	1000	600	1100
269	310	310	234
120	AWG 10 ...250 kcmil	AWG 10 ...250 kcmil	120
8 / 3			
/ V-0			

KEMA 98ATEX1684 U

EN 50124

- 6...150
- 6...120
- 16...150
- 16...120
- 10...20

Auxiliary connection available up to 4mm²/32A (see section accessories).



55 x 163 x 79
415 / 240
10... 240

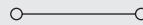

EEx e II T II 2 G D

IEC	UL	CSA	EN 50019
1000	1000	600	1100
353	380	360	307
185	AWG 8 ...500 kcmil	AWG 8 ...500 kcmil	185
8 / 3			
/ V-0			

KEMA 98ATEX1684 U

EN 50124

- 10...240
- 10...185
- 25...240
- 25...185
- 14...31

Auxiliary connection available up to 4mm²/32A (see section accessories).

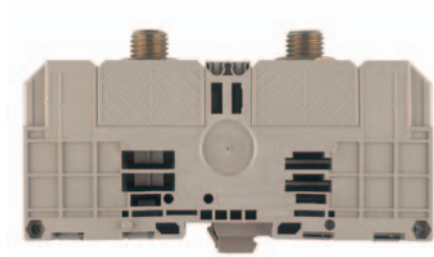

55 x 163 x 86
520 / 300
25... 300

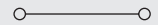

EEx e II T II 2 G D

IEC	UL	CSA	EN 50019
1000	1000	600	1100
520	500	510	452
300	AWG 6 ...600 kcmil	AWG 6 ...600 kcmil	300
8 / 3			
/ V-0			

KEMA 98ATEX1684 U

EN 50124

- 25...240
- 25...240
- 50...300
- 50...240
- 25...60

Auxiliary connection available up to 4mm²/32A (see section accessories).

Type	Qty.	Order No.
WFF 120	5	1028500000
WFF 120 BL	5	1028580000
WFF 120/AH	5	1029500000

Type	Qty.	Order No.
WFF 185	4	1028600000
WFF 185 BL	4	1028680000
WFF 185/AH	4	1029600000

Type	Qty.	Order No.
WFF 300	4	1028700000
WFF 300 BL	4	1028780000
WFF 300/AH	4	1029700000

Type	Current [A]	Qty.	Order No.
WQL 2 WFF120	269	5	1065100000
WQL 3 WFF120	269	5	1065600000

Type	Current [A]	Qty.	Order No.
WQL 2 WFF185	353	5	1065200000
WQL 3 WFF185	353	5	1065700000

Type	Current [A]	Qty.	Order No.
WQL 2 WFF300	520	5	1065300000
WQL 3 WFF300	520	5	1065800000

Width [mm]			
WTW WFF120	2	10	1067300000

Width [mm]			
WTW WFF185/300	2	10	1067400000

Width [mm]			
WTW WFF185/300	2	10	1067400000

Width [mm]			
WEW 35/1	12.2	50	1059000000

Width [mm]			
WEW 35/1	12.2	50	1059000000

Width [mm]			
WEW 35/1	12.2	50	1059000000

WD 1 25 K KARTE A 6 ST	5	1563900000
------------------------	---	------------

WD 1 25 K KARTE A 6 ST	5	1563900000
------------------------	---	------------

WD 1 25 K KARTE A 6 ST	5	1563900000
------------------------	---	------------

WS 12/6,5

At the unused contact points, the cover plate WAP is used together with the hood WAH.

WS 12/6,5

At the unused contact points, the cover plate WAP is used together with the hood WAH.

WS 12/6,5

At the unused contact points, the cover plate WAP is used together with the hood WAH.

2-stud terminals

ST4000 (up to 4kV)

When using ATEX certified components in hazardous area applications the installation instructions and the rated data for accessories in the technical appendix must be considered.

Width/Length/Height with TS35x7.5	mm
Max. current / max. cond. cross-section	A/mm ²
Max. clamping range	mm ²

Technical data

Rated data w. partition, Wemid	
Rated voltage	V
Rated current	A
Rated cross-section	mm ²
Rated impulse voltage / Pollution severity	kV/-
Plug gauge IEC 60-947-1 / flammability class acc. UL94	
Approvals	

Rated data w. partition, Epoxy resin	
Rated voltage / Rated impulse voltage	V/kV

Cable lugs, clamp.	
DIN 46234 / 1 cable lug per side	mm ²
DIN 46234 / 2 cable lugs per side	mm ²
DIN 46235 / 1 cable lug per side	mm ²
DIN 46235 / 2 cable lugs per side	mm ²
Tightening torque range	Nm

Information

Ordering data

Version
red
with internal thread

Information

Accessories

Cross-connection	
	2-pole
	3-pole
WQL	4-pole

Busbar	
Conn. betw. studs of a terminal	M8 / Thickness 4mm M10 / thickness 4mm M10 / Thickness 6mm M12 / Thickness 4mm M12 / Thickness 6mm

Connecting piece	
to place 2 terminals next to each other without partition	Length 130mm Length 160mm

Partition	
	Length 150mm Length 180mm

End plate	
to finish the terminal block	Length 150mm Length 180mm

Shock protection	
	Length 150mm Length 180mm
with internal thread	Fixing nut

Marking systems (see large assortment in chapter M)	
	Tags

For detailed information on additional accessories and usage instructions see chapter accessories.

ST 4000/S M8

120 mm²

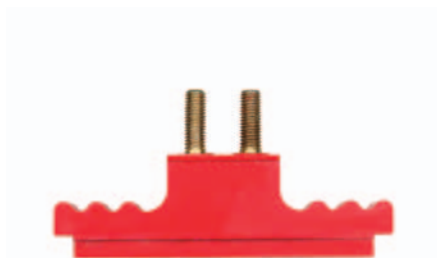

40 x 150 x 84	
269 / 120	
1.5 ... 120	

IEC	UL	CSA	EN 50019
4000			
269			
120			
	30 / 3		
	/ V-0		

EN 50124

1.5 - 120
16...70
6.0...12

Rated Voltage preconditioning cable lug according DIN 46234

Type	Qty.	Order No.
ST 4000/S M8	25	1809110000
ST 4000/S M8 F	25	1809120000

Based on the customer specification Weidmüller will provide drawings of the terminal board

Type	Current [A]	Qty.	Order No.
ST 4000/S J2 M8	269	100	1809310000
ST 4000/S J3 M8	269	50	1809320000
ST 4000/S J4 M8	269	25	1809330000

Type	Qty.	Order No.
ST 4000/S CB M8/4	100	1809250000

ST 4000/S C130	50	1809230000
----------------	----	------------

Width [mm]	Qty.	Order No.
ST 4000/S P150	10 50	1809190000

Width [mm]	Qty.	Order No.
ST 4000/S E150	10 50	1809210000

ST 4000/S S150	20	1809470000
----------------	----	------------

ST 4000 K M8	50	1809510000
--------------	----	------------

ST 4000/S M M8

ST 4000/S M10

120 mm²

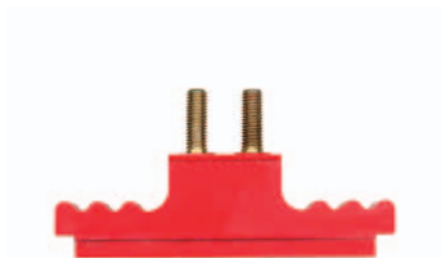

40 x 150 x 84	
269 / 120	
4 ... 120	

IEC	UL	CSA	EN 50019
4000			
269			
120			
	30 / 3		
	/ V-0		

EN 50124

4 - 120
10...20

Rated Voltage preconditioning cable lug according DIN 46234

Type	Qty.	Order No.
ST 4000/S M10	25	1809130000
ST 4000/S M10 F	25	1809140000

Based on the customer specification Weidmüller will provide drawings of the terminal block

Type	Current [A]	Qty.	Order No.
ST 4000/S J2 M10	269	100	1809340000
ST 4000/S J3 M10	269	50	1809350000
ST 4000/S J4 M10	269	25	1809360000

Type	Qty.	Order No.
ST 4000/S CB M10/4	100	1809260000
ST 4000/S CB M10/6	100	1809270000

ST 4000/S C130	50	1809230000
----------------	----	------------

Width [mm]	Qty.	Order No.
ST 4000/S P150	10 50	1809190000

Width [mm]	Qty.	Order No.
ST 4000/S E150	10 50	1809210000

ST 4000/S S150	20	1809470000
----------------	----	------------

ST 4000 K M10	50	1809520000
---------------	----	------------

ST 4000/S M M10

2-stud terminals

ST 4000/L M10

150 mm²

ST 4000/L M12

240 mm²

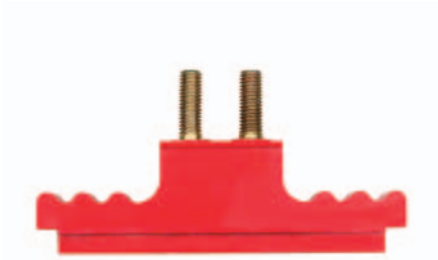

55 x 180 x 90
309 / 150
10 ... 150

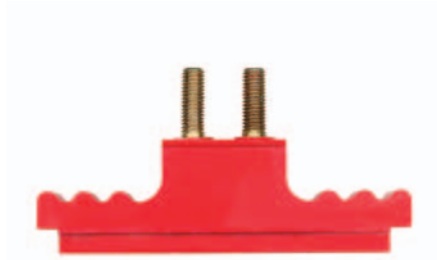
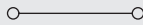

55 x 180 x 90
415 / 240
10 ... 240

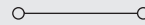

IEC	UL	CSA	EN 50019
4000			
309			
150			
	29,5 / 3		
	/ V-0		

EN 50124

10 - 150

25 - 150

10...20

Rated Voltage preconditioning cable lug according DIN 46234

IEC	UL	CSA	EN 50019
4000			
415			
240			
	29,5 / 3		
	/ V-0		

EN 50124

10...240

25...240

14...31

Rated Voltage preconditioning cable lug according DIN 46234

Type	Qty.	Order No.
ST 4000/L M10	15	1809150000
ST 4000/L M10 F	15	1809160000

Based on the customer specification Weidmüller will provide drawings of the terminal board

Type	Qty.	Order No.
ST 4000/L M12	15	1809170000
ST 4000/L M12 F	15	1809180000

Based on the customer specification Weidmüller will provide drawings of the terminal board

Type	Current [A]	Qty.	Order No.
ST 4000/L J2 M10	309	50	1809370000
ST 4000/L J3 M10	309	50	1809380000
ST 4000/L J4 M10	309	25	1809390000

Type	Qty.	Order No.
ST 4000/L CB M10/4	100	1809280000

Type	Width [mm]	Qty.	Order No.
ST 4000/L C160	50	50	1809240000

Type	Width [mm]	Qty.	Order No.
ST 4000/L P180	10	50	1809200000

Type	Width [mm]	Qty.	Order No.
ST 4000/L E180	10	50	1809220000

Type	Qty.	Order No.
ST 4000/L S180	50	1809480000

Type	Qty.	Order No.
ST 4000 K M10	50	1809520000

ST 4000/L M M10

Type	Current [A]	Qty.	Order No.
ST 4000/L J2 M12	415	50	1809400000
ST 4000/L J3 M12	415	50	1809410000
ST 4000/L J4 M12	415	25	1809420000

Type	Qty.	Order No.
ST 4000/L CB M12/4	100	1809290000
ST 4000/L CB M12/6	100	1809300000

Type	Width [mm]	Qty.	Order No.
ST 4000/L C160	50	50	1809240000

Type	Width [mm]	Qty.	Order No.
ST 4000/L P180	10	50	1809200000

Type	Width [mm]	Qty.	Order No.
ST 4000/L E180	10	50	1809220000

Type	Qty.	Order No.
ST 4000/L S180	50	1809480000

Type	Qty.	Order No.
ST 4000 K M12	50	1809530000

ST 4000/L M M12

