

# HIGH POWER SPEC Pak™

Sealed Power For Environmental Connections



Marine | Wind Power | Lighting | Transportation | Pumps | Ground Support  
Machine Tool | Industrial Automation | Motor | Solar Power | Harsh Environments



**APP**  
Anderson Power Products

# Rugged and Sealed (IP68) Plugs and Receptacles

For Use with APP® Powerpole® Signal, Power & Ground Contacts & Housings

The SPEC Pak™ High Power uses rugged and environmentally sealed (IP68) shells to protect APP® Powerpole® contacts and housings. Customer configured SPEC Pak™ High Power Connectors are capable of up to 260 amps and may be used anywhere a rugged and/or waterproof high power, signal and ground interconnect solution is required.

The SPEC Pak™ High Power shell accepts 75 to 180 amp Powerpole® contacts and up to 8 auxiliary contacts. The wide range of Powerpole® housing colors and contact sizes, coupled with the available Powerpole® insert holders, offers the user a wide array of design options. Wire sizes which can accommodate a range from 24 to 3/0 AWG (0.25 to 85.0 mm<sup>2</sup>). SPEC Pak™ High Power is highly configurable with thousands of design options in a single interconnect.

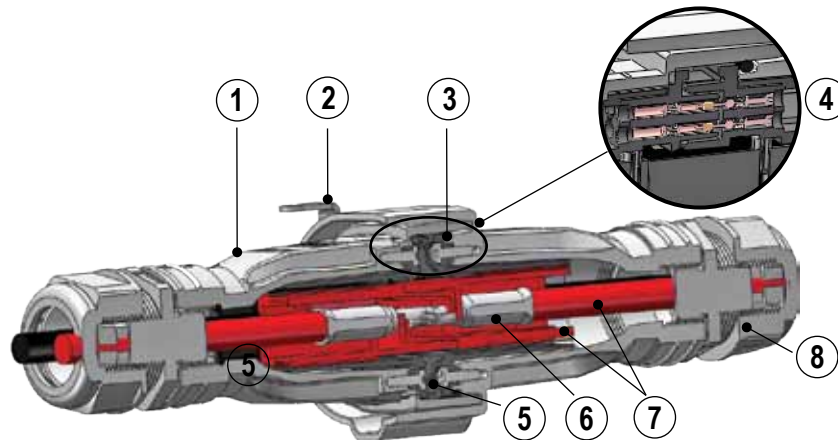

## 5 Powerpole® Insert Arrangement



H02



H03



H06

## 1 - Chemical & UV Resistant Ruggedized Shells

- Wire to wire configurations
- Wire to Panel configurations

## 2 - Stainless Steel Latches (securing plug to receptacle)

## 3 - IP68 Interfacial Sealing O-Ring

## 4 - Auxiliary Contacts (up to 8)

## 5 - Powerpole® Insert Holders (user configurable)

- H02 Arrangement - up to two PP180 & 8 auxiliaries
- H03 Arrangement - up to three PP120 & 8 auxiliaries
- H06 Arrangement - up to six PP75 & 8 auxiliaries

## 6 - Power Contacts (up to 260 amps with 3/0 AWG)

## 7- Color Coded Powerpole® Housings Match Wire Colors

## 8 - Industry Standard Sealing (IP68) Components

- PG Gland Compatible - Size 36 and 42
- Multi-hole Glands For Use With Discrete Wires
- Single Hole Glands For Use With Jacketed Cable

# Specifications

## High Power SPEC Pak™ Shell / Components

### Electrical

UL Voltage Rating (AC/DC)	600
Dielectric Withstanding Voltage (AC)	3000
Operating Temperature (°C)	-40 to 105 *
(°F)	-40 to 221
Flammability Rating of SPEC Pak™ Shells	UL94 V-0
UV Rating (equivalent)	UL746C F1

### Mechanical

Shell/Latch Mating Cycles	1,500 Min.
Average Connect/Disconnect (lbf)	28
(N)	125
IP Rating	IP68
UL50 Sec. 36 Sealing Requirement	Pass
Crush Test per EIA-364-40B	Pass
Drop Test per UL50E	Pass

### Material

SPEC Pak™ - Receptacle, Plug & Holders	PBT
Latch	Stainless Steel
Latch Retainer	Stainless Steel
Holder Mount Hardware	Nickel Plated Steel



**Mated Pair  
High Power Plug To  
Inline Receptacle**

Powerpole® Contacts	PP180	PP120	PP75	PowerMod®
UL Current Rating (Amperes) **	260	190	70	5
CSA (30C Rise) (Amperes) **	140	100	40	5
Voltage Rating (AC/DC)	600	600	600	600
Contact Barrel Wire Size (AWG)	3/0 to 6	1/0 to 6	6 to 12	12 to 24
(mm <sup>2</sup> )	85 to 13.3	53.5 to 13.3	13.3 to 3.3	4.0
Average Contact Resistance (milliohm)	0.10	0.14	0.20	3.00
Contact Retention Force (lbf)	170	100	50	8
(N)	756	445	222	36
Operating Temperature (°C)	-20 to 105 *	-20 to 105 *	-20 to 105 *	-20 to 105 *
(°F)	-4 to 221	-4 to 221	-4 to 221	-4 to 221
Flammability Rating	UL94 V-0	UL94 V-0	UL94 V-0	UL94 V-0
Contact Materials	Copper	Copper	Copper	Copper Alloy
Contact Plating	Silver	Silver	Silver	Gold over Nickel
<b>Mechanical</b>				
Mating Cycles - no load	10,000	10,000	10,000	10,000
Average Connect/Disconnect (lbf)	20	8	5 (Low Detent) 7 (High Detent)	10 oz. (3N) Average
<b>Material</b>				
Powerpole® Housing Material	Polycarbonate	Polycarbonate	Polycarbonate	PBT

### NOTE:

\* -40° to 120° C (-40° to 248° F) can be achieved by using APP Chemical Resistant Powerpole® housing. Contact factory for more information.

\*\* Based on Panel Mount Receptacle to Plug configuration.

1. Agency approvals - TUV Pending / Patents &

Pending  File No. E26226



# Part Number Configurator

## PART NUMBER PLAN

SPEC Pak™ Series (1 Fixed Character)	Shell Color (1 Character)	Shell Style (1 Character)	Dash	Shell Size (mm) (3 Characters)	Insert Arrangement (3 Characters)
<b>S</b>	<b>K</b>	<b>2</b>	<b>-</b>	<b>095</b>	<b>H02</b>
S = SPEC Pak™ Series	K = Black	1 = Inline Receptacle 2 = Panel Mount Receptacle 6 = Straight Plug 9 = Environmental Receptacle Cover 9P = Environmental Plug Cover		095 = 095mm Panel Mount Receptacle Shell A95 = 095mm Shell, PG 36 B95 = 095mm Shell, PG 42	Detailed Information Is Available On: H02 = PP180, 2 Pole ..... Page 7 H03 = PP120 Housing, 3 Pole ..... Page 8 H06 = PP75, 6 Pole ..... Page 9

### PLUG KIT

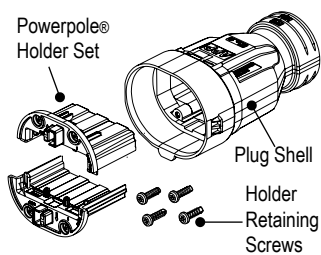

#### Ordering Information

- Part Number & Description
- SK6-A95H02**  
- Plug Kit, PG 36 compatible shell with 2 pole PP180 holder
- SK6-A95H03**  
- Plug Kit, PG 36 compatible shell with 3 pole PP120 holder
- SK6-A95H06**  
- Plug Kit, PG 36 compatible shell with 6 pole PP75 holder
- SK6-B95H02**  
- Plug Kit, PG 42 compatible shell with 2 pole PP180 holder
- SK6-B95H03**  
- Plug Kit, PG 42 compatible shell with 3 pole PP120 holder
- SK6-B95H06**  
- Plug Kit, PG 42 compatible shell with 6 pole PP75 holder

**NOTE:**  
- Panel Mount Receptacle mounting hardware (8 each #10 or M5 screw) not included  
- Recommended torque for mounting hardware is 15 to 20 in-lbf (1.7 to 2.2 N-m)

### PANEL MOUNT RECEPTACLE KIT

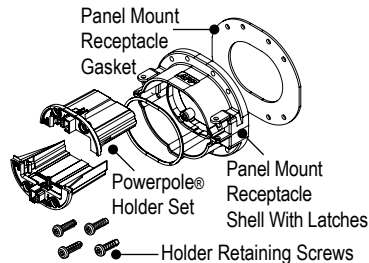

#### Ordering Information

- Part Number & Description
- SK2-095H02**  
- Panel Mount Receptacle Kit with 2 pole PP180 holder
- SK2-095H03**  
- Panel Mount Receptacle Kit with 3 pole PP120 holder
- SK2-095H06**  
- Panel Mount Receptacle Kit with 6 pole PP75 holder

### INLINE RECEPTACLE KIT

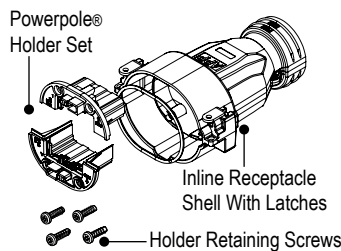

#### Ordering Information

- Part Number & Description
- SK1-A95H02**  
- Inline Receptacle Kit, PG 36 compatible shell with, 2 pole PP180 holder
- SK1-A95H03**  
- Inline Receptacle Kit, PG 36 compatible shell with, 3 pole PP120 holder
- SK1-A95H06**  
- Inline Receptacle Kit, PG 36 compatible shell with, 6 pole PP75 holder
- SK1-B95H02**  
- Inline Receptacle Kit, PG 42 compatible shell with, 2 pole PP180 holder
- SK1-B95H03**  
- Inline Receptacle Kit, PG 42 compatible shell with, 3 pole PP120 holder
- SK1-B95H06**  
- Inline Receptacle Kit, PG 42 compatible shell with, 6 pole PP75 holder

### COVER KIT

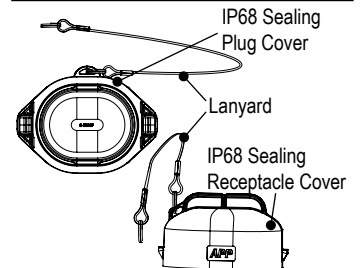

#### Ordering Information

- Part Number & Description
- SK9-095**  
- Receptacle Cover Kit with lanyard
- SK9P-095**  
- Plug Cover Kit with lanyard

### Component Replacement Parts

- Part Number & Description
- H1120P41**  
- #8 x 5/8 screw - Bulk Packaged

## PART NUMBER PLAN

Wire Protection See page 6 (4 Characters)	Housing Arrangement For more information see pages 7 thru 9 Dash (1 Character)	Contact Dash (2 Characters)	APP Content (3 Characters)
<b>PS</b>	<b>00</b>	<b>-</b>	<b>0</b>
00 = None PS = Plastic Short PM = Plastic Multi-hole	00 = None 00 - 99 = Various Gland Type	-	0
		<b>00</b>	<b>-</b>
			<b>A01</b>
			Custom Configuration

Insert Arrangement	Contact Code	Contact	Wire Size AWG (mm <sup>2</sup> )	Available in Insert Arrangement
-	00	Custom Configuration - Use Next Section		
0 = Custom Configuration	11	5900	#6 13.3	H06
A = AC Single Phase	12	5952	#8 8.4	H06
B = AC 3 Phase, 3 Wire	13	5915	#10 to 12 5.3 to 3.3	H06
E = AC 3 Phase, 4 wire	14	5900 with Auxiliary	#6 13.3	H06
F = AC 3 phase, 5 wire	15	5952 with Auxiliary	#8 8.4	H06
G = DC 2 Circuit, 6 wire	16	5915 with Auxiliary	#10 to 12 5.3 to 3.3	H06
R = DC 1 Circuit, 2 Wire				
Z = All Black				
	20	1323G2	1/0 53.5	H03
	21	1323G1	#1 42.4	H03
	22	1319	#2 33.6	H03
	23	1319G4	#4 21.2	H03
	24	1319G6	#6 13.3	H03
	25	1323G2 with Auxiliary	1/0 53.5	H03
	26	1323G1 with Auxiliary	#1 42.4	H03
	27	1319 with Auxiliary	#2 33.6	H03
	28	1319G4 with Auxiliary	#4 21.2	H03
	29	1319G6 with Auxiliary	#6 13.3	H03
	80	1328G2	3/0 85.0	H02
	81	1328G1	2/0 67.4	H02
	82	1382	1/0 53.5	H02
	83	1347	#1 42.4	H02
	84	1383	#2 33.6	H02
	85	1384	#4 21.2	H02
	86	1348	#6 13.3	H02
	87	1328G2 with Auxiliary	3/0 85.0	H02
	88	1328G1 with Auxiliary	2/0 67.4	H02
	89	1382 with Auxiliary	1/0 53.5	H02
	90	1347 with Auxiliary	#1 42.4	H02
	91	1383 with Auxiliary	#2 33.6	H02
	92	1384 with Auxiliary	#4 21.2	H02
	93	1348 with Auxiliary	#6 13.3	H02

### Part Numbering Notes:

- 1) To order SPEC Pak™ Shell Kits only (no internal Powerpole® housings or contacts), use part numbering on page 4 only. **Plug Shell Kit Example: SK6-A95H02 or SK6-B95H02.** Powerpole® housings, contacts and wire protection may be ordered separately, see pages 6 thru 9 for information.
- 2) To order customer configured SPEC Pak™ connectors (including internal Powerpole® housings and contacts) use Part Number Plan across the top of pages 4 and 5. **Customer Configured SPEC Pak™ Plug Connector Example: SK6-A95H03PS04-A22.**
- 3) To order a custom configuration which is not listed on page 7 thru 9, use APP custom part number configurator on the APP® website, [www.andersonpower.com](http://www.andersonpower.com) or contact factory.

NOTE: 1. Custom configurations may not be UL Recognized.

2. Contact code designation #14 to 16, #25 to 29 and #87 to 93 use 4 each of part number PM1612S30 (Pins) & 4 each of part number PM16S12S32 (Sockets) as signal.

# Wire Protection - PG Gland

## SPECIFICATIONS

Material		Mechanical		Torque Requirements
Shell	Nylon PA 66 (UL94 V-2)	Operating Temp	-40°C to 105°C (-40°F to 221°F)	Cable Gland Body to Plug Housing
Gasket	EPDM	IP Rating	IP68	- Hand tighten until snug, tighten additional 1/8 - 1/4 turn with wrench
Color	Black	UV Rating	Equivalent to UL746C F1	Sealing Nut to Cable
		Thread Type	PG	- Hand tighten until snug, tighten additional 1/2 - 3/4 turn with wrench



## STRAIGHT PLASTIC SHORT THREAD TYPE - STD PACK 10 / UL LISTED

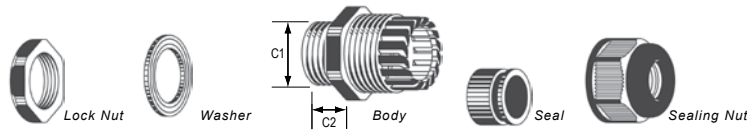

APP® P/N	Wire Protection Designation (4 Characters)	PG Gland Size	Number Of Holes	Cable Range Wire Outer Dia. mm (in)	Thread O.D. C1 mm (in)	Panel Mounting Hole mm (in)	Thread Length C2 mm (in)	Wrench Size Lock Nut (mm)	Wrench Size Sealing Nut (mm)
PS1P36-26X	PS04	36	1	26.5 - 21.0 (1.04 - 0.83)	47 (1.85)	47 - 47.4 (1.85 - 1.67)	15 (0.59)	57	52
PS1P36-32X	PS05	36	1	32.0 - 24.0 (1.26 - 0.94)	47 (1.85)	47 - 47.4 (1.85 - 1.67)	15 (0.59)	57	52
PL1P42-19X	PS01	42	1	19.5 - 16.0 (0.77 - 0.63)	54 (2.13)	54 - 54.4 (2.13 - 2.14)	15.5 (0.61)	64	62
PS1P42-32X	PS02	42	1	32.0 - 26.0 (1.26 - 0.79)	54 (2.13)	54 - 54.4 (2.13 - 2.14)	15.5 (0.61)	64	62
PS1P42-41X	PS03	42	1	41.0 - 31.0 (1.61 - 1.22)	54 (2.13)	54 - 54.4 (2.13 - 2.14)	15.5 (0.61)	64	62

## STRAIGHT PLASTIC MULTI-HOLE TYPE - STD PACK 10 / NOT UL LISTED

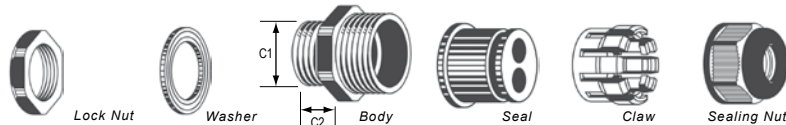

APP® P/N	Wire Protection Designation (4 Characters)	PG Gland Size	Number Of Holes	Cable Range Wire Outer Dia. mm (in)	Thread O.D. C1 mm (in)	Panel Mounting Hole mm (in)	Thread Length C2 mm (in)	Wrench Size Lock Nut (mm)	Wrench Size Sealing Nut (mm)
PS2P36-13X	PM21	36	2	13.0 - 11.0 (0.51 - 0.43)	47 (1.85)	47 - 47.4 (1.85 - 1.67)	15 (0.59)	57	52
PS2P36-9X	PM22	36	2	9.0 - 7.0 (0.35 - 0.28)	47 (1.85)	47 - 47.4 (1.85 - 1.67)	15 (0.59)	57	52
PS3P36-7X	PM31	36	3	7.8 - 6.5 (0.31 - 0.26)	47 (1.85)	47 - 47.4 (1.85 - 1.67)	15 (0.59)	57	52
PS3P36-10X	PM32	36	3	10 - 7.7 (0.39 - 0.30)	47 (1.85)	47 - 47.4 (1.85 - 1.67)	15 (0.59)	57	52
PS4P36-12X	PM41	36	4	12.0 - 10.0 (0.48 - 0.39)	47 (1.85)	47 - 47.4 (1.85 - 1.67)	15 (0.59)	57	52
PS5P36-8X	PM51	36	5	8.3 - 6.5 (0.33 - 0.26)	47 (1.85)	47 - 47.4 (1.85 - 1.67)	15 (0.59)	57	52
PL4P42-10X	PM46	42	4	10.5 - 8.5 (0.41 - 0.33)	54 (2.13)	54 - 54.4 (2.13 - 2.14)	15.5 (0.61)	64	62
PL6P42-7X	PM66	42	6	7.0 - 5.0 (0.28 - 0.20)	54 (2.13)	54 - 54.4 (2.13 - 2.14)	15.5 (0.61)	64	62
PL8P42-7X	PM86	42	8	7.0 - 5.7 (0.28 - 0.22)	54 (2.13)	54 - 54.4 (2.13 - 2.14)	15.5 (0.61)	64	62

**NOTE:**

- Other PG Gland configurations and specifications are available, please contact the factory.
- Only UL listed cable glands are UL recognized components when used with SPEC Pak™ connector(s).
- Shading indicates stock item.

# H02 Insert Arrangement

Configured with up to 2 PP180 Contacts (up to 260 amps)

Standard & Custom Configuration Options

## HOUSING ARRANGEMENT

### 0 Custom Configuration

DC 1 Circuit, 2 Wire

R 1381G1 1381G3

All Black

Z 1381G1 1381G1

## POWERPOLE® INSERT HOLDER



H02

**NOTE:**

1. For custom configuration, use APP® custom part number configurator at [www.andersonpower.com](http://www.andersonpower.com) or contact the factory.
2. Arrangement represents front view of the receptacle.

## POWERPOLE® CONTACTS & HOUSINGS FOR H02 INSERT ARRANGEMENT

### PP180 Contacts

Standard Part Number	Minimum & Multiples	Packaged Part Number	Minimum & Multiples	Contact Code Designation	Description	Wire Size (AWG)
1328G2-BK	100	1328G2	20	80	Individual	3/0
1328G1-BK	100	1328G1	20	81	Individual	2/0
1382-BK	500	1382	10	82	Individual	1/0
1347-BK	500	1347	10	83	Individual	#1
1383-BK	500	1383	10	84	Individual	#2
1384-BK	500	1384	10	85	Individual	#4
1348-BK	200	1348	10	86	Individual	#6

### PP180 Contact Housings

Standard Part Number	Minimum & Multiples	Packaged Part Number	Minimum & Multiples	Description
1381G1-BK	250	1381G1	10	Black
1381-BK	250	1381	10	Blue
1381G4-BK	250	1381G4	10	Green
1381G3-BK	250	1381G3	10	Red
1381G2-BK	250	1381G2	10	White

### Signal Contacts for Standard & Custom Configurations

Standard Part Number	Minimum & Multiples	Packaged Part Number	Minimum & Multiples	Contact Code Designation	Description	Wire Size (AWG)
PM16P12S30	500	PM16P12S30-50	50	87 thru 93	Individual	#12
PM16P1416S30	500	PM16P1416S30-50	50	-	Individual	#14 to 16
PM16P1620S30	500	PM16P1620S30-50	50	-	Individual	#16 to 20
PM16P2024S30	500	PM16P2024S30-50	50	-	Individual	#20 to 24
PM16S12S32	500	PM16S12S32-50	50	87 thru 93	Individual	#12
PM16S1416S32	500	PM16S1416S32-50	50	-	Individual	#14 to 16
PM16S1620S32	500	PM16S1620S32-50	50	-	Individual	#16 to 20
PM16S2024S32	500	PM16S2024S32-50	50	-	Individual	#20 to 24

**NOTE:**

1. Contact code designation #87 to 93 is 4 each of PM16P12S30 (pins) & 4 each of part number PM16S12S32 (sockets) as signal.
2. See Powerpole® & Multipole Power Connectors Catalog for additional contacts and/or housings options.
3. Application tooling information is available on page 12.

# H03 Insert Arrangement

Configured with up to 3 PP120 Contacts (up to 190 amps)  
Standard & Custom Configuration Options

## HOUSING ARRANGEMENT

**0** Custom Configuration

### AC Single Phase

**A** 1321G1 1321G2 1321G4

### DC 1 Circuit, 2 Wire

**R** 1321G1 1321G3 E

### All Black

**Z** 1321G1 1321G1 1321G1

## POWERPOLE® INSERT HOLDER



H03

**NOTE:**

1. E = Empty
2. For custom configuration, use APP® custom part number configurator at [www.andersonpower.com](http://www.andersonpower.com) or contact the factory.
3. Arrangement represents front view of the receptacle.

## POWERPOLE® CONTACTS & HOUSINGS FOR H03 INSERT ARRANGEMENT

### PP120 Contacts

Standard Part Number	Minimum & Multiples	Packaged Part Number	Minimum & Multiples	Contact Code Designation	Description	Wire Size (AWG)
1323G2-BK	100	1323G2	20	20	Individual	1/0
1323G1-BK	100	1323G1	20	21	Individual	#1
1319-BK	500	1319	20	22	Individual	#2
1319G4-BK	500	1319G4	20	23	Individual	#4
1319G6-BK	500	1319G6	20	24	Individual	#6

### PP120 Contact Housings

Standard Part Number	Minimum & Multiples	Packaged Part Number	Minimum & Multiples	Description
1321G1-BK	500	1321G1	20	Black
1321-BK	500	1321	20	Blue
1321G4-BK	500	1321G4	20	Green
1321G3-BK	500	1321G3	20	Red
1321G2-BK	500	1321G2	20	White

### Signal Contacts for Standard & Custom Configurations

Standard Part Number	Minimum & Multiples	Packaged Part Number	Minimum & Multiples	Contact Code Designation	Description	Wire Size (AWG)
PM16P12S30	500	PM16P12S30-50	50	25 thru 29	Individual	#12
PM16P1416S30	500	PM16P1416S30-50	50	-	Individual	#14 to 16
PM16P1620S30	500	PM16P1620S30-50	50	-	Individual	#16 to 20
PM16P2024S30	500	PM16P2024S30-50	50	-	Individual	#20 to 24
PM16S12S32	500	PM16S12S32-50	50	25 thru 29	Individual	#12
PM16S1416S32	500	PM16S1416S32-50	50	-	Individual	#14 to 16
PM16S1620S32	500	PM16S1620S32-50	50	-	Individual	#16 to 20
PM16S2024S32	500	PM16S2024S32-50	50	-	Individual	#20 to 24

**NOTE:**

1. Contact code designation #25 to 29 uses 4 each of PM16P12S30 (pins) & 4 each of part number PM16S12S32 (sockets) as signal.
2. See Powerpole® & Multipole Power Connectors Catalog for additional contacts and/or housings options.
3. Application tooling information is available on page 12.



# H06 Insert Arrangement

Configured with up to 6 PP75 Contacts (up to 75 amps)  
Standard & Custom Configuration Options

## HOUSING ARRANGEMENT

### 0 Custom Configuration

#### AC 3 Phase, 3 Wire

B	5916G4	5916G5	5916G7
	E	5916G6	E

#### AC 3 Phase, 4 Wire

E	5916G4	5916	5916G5
	5916G6	5916G7	E

#### AC3 Phase, 5 Wire

F	5916G4	5916G5	5916G7
	5916	5916G6	5916

#### DC 2 Circuit, 6 Wire

G	5916G4	5916G4	5916G4
	5916G7	5916G7	5916G7

## POWERPOLE® INSERT HOLDER



H06

**NOTE:**

1. E = Empty
2. For custom configuration, use APP® custom part number configurator at [www.andersonpower.com](http://www.andersonpower.com) or contact the factory.
3. Arrangement represents front view of the receptacle.

## POWERPOLE® CONTACTS & HOUSINGS FOR H06 INSERT ARRANGEMENT

### PP75 Contacts

Standard Part Number	Minimum & Multiples	Packaged Part Number	Minimum & Multiples	Contact Code Designation	Description	Wire Size (AWG)
5900-BK	1000	5900	25	11	Individual	#6
5952-BK	1000	5952	25	12	Individual	#8
5915-BK	1000	5915	100	13	Individual	#10 to 12

### PP75 Contact Housings

Standard Part Number	Minimum & Multiples	Packaged Part Number	Minimum & Multiples	Description
5916G4-BK	1000	5916G4	25	Black
5916-BK	1000	5916	25	Blue
5916G6-BK	1000	5916G6	25	Green
5916G7-BK	1000	5916G7	25	Red
5916G5-BK	1000	5916G5	25	White

### Signal Contacts for Standard & Custom Configurations

Standard Part Number	Minimum & Multiples	Packaged Part Number	Minimum & Multiples	Contact Code Designation	Description	Wire Size (AWG)
PM16P12S30	500	PM16P12S30-50	50	14 thru 16	Individual	#12
PM16P1416S30	500	PM16P1416S30-50	50	-	Individual	#14 to 16
PM16P1620S30	500	PM16P1620S30-50	50	-	Individual	#16 to 20
PM16P2024S30	500	PM16P2024S30-50	50	-	Individual	#20 to 24
PM16S12S32	500	PM16S12S32-50	50	14 thru 16	Individual	#12
PM16S1416S32	500	PM16S1416S32-50	50	-	Individual	#14 to 16
PM16S1620S32	500	PM16S1620S32-50	50	-	Individual	#16 to 20
PM16S2024S32	500	PM16S2024S32-50	50	-	Individual	#20 to 24

**NOTE:**

1. Contact code designation #14 to 16 uses 4 each of PM16P12S30 (pins) & 4 each of part number PM16S12S32 (sockets) as signal.
2. See Powerpole® & Multipole Power Connectors Catalog for additional contacts and/or housings options.
3. Application tooling information is available on page 12.

# Dimensions

## PLUG

Top View

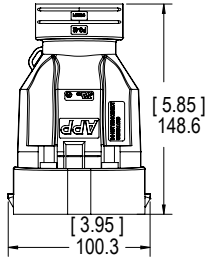

Side View

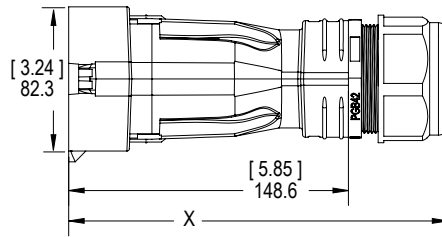

APPROXIMATE OVERALL LENGTH W/ GLAND

	X	
	MM	IN
Shell with PG 36	193	7.6
Shell with PG 42	201	7.9

Insert Arrangements

Front View - H02

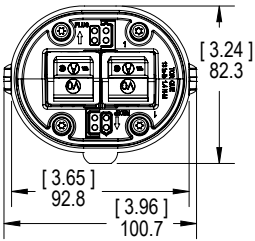

Front View - H03

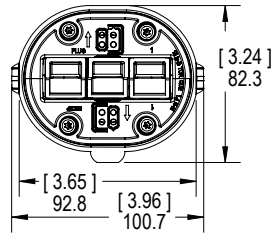

Front View - H06

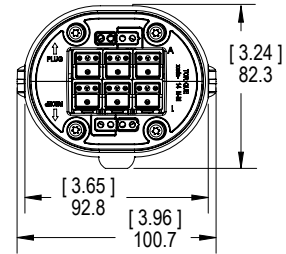

## MATED SIDE VIEW

Plug to Panel Mount Receptacle

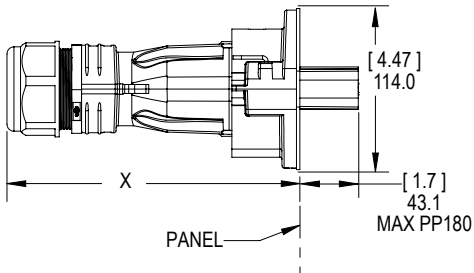

PLUG TO PANEL MOUNT RECEPTACLE

	X			
	MM	IN	MM	IN
Shell with PG 36	114.0	4.7	200.7	7.90
Shell with PG 36	114.0	4.7	207.3	8.16

Plug to Inline Receptacle

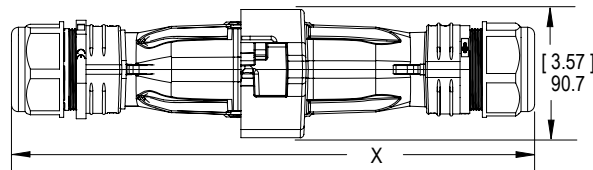

PLUG TO INLINE RECEPTACLE

	X			
	MM	IN	MM	IN
Shell with PG 36	90.7	3.57	354.1	13.94
Shell with PG 36	90.7	3.57	370.3	14.58

## PLUG COVER

Front View

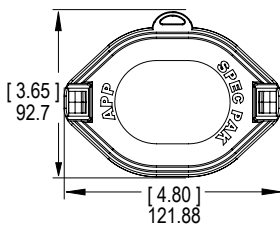

Side View

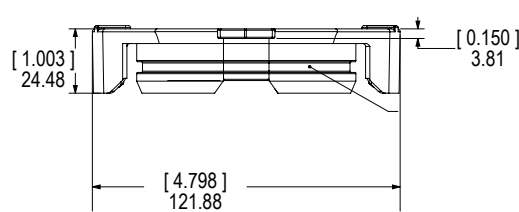

## INLINE RECEPTACLE

**Top View**

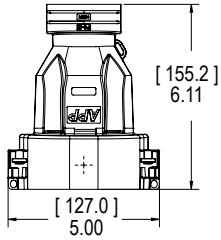

**Side View**

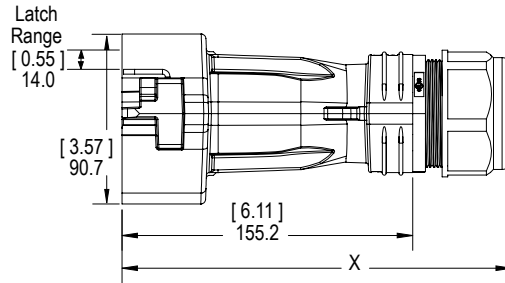

**APPROXIMATE OVERALL LENGTH W/ GLAND**

	X	
	MM	IN
Shell with PG 36	200	7.9
Shell with PG 42	208	8.2

**Insert Arrangements  
Front View - H02**

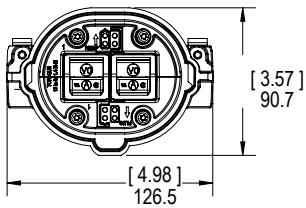

**Front View - H03**

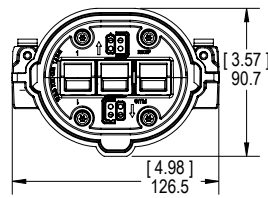

**Front View - H06**

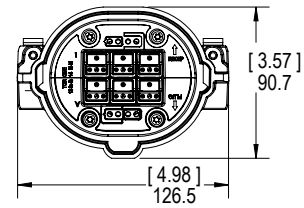

## PANEL MOUNT RECEPTACLE

**Panel Cutout**

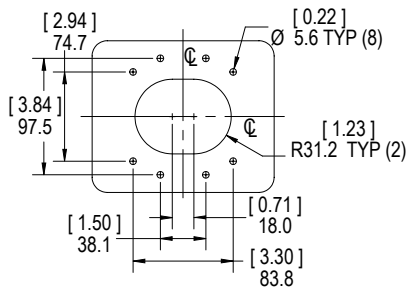

**Top View**

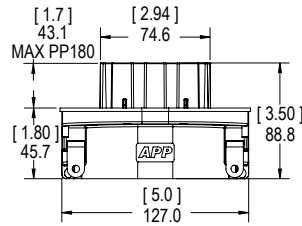

**Side View**

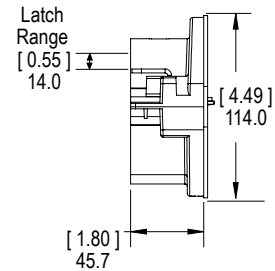

**Insert Arrangements  
Front View - H02**

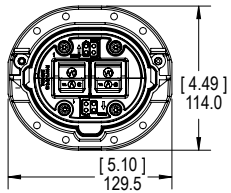

**Front View - H03**

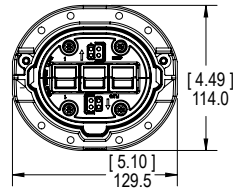

**Front View - H06**

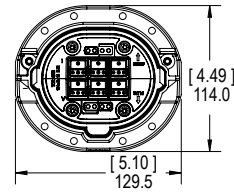

## RECEPTACLE COVER

**Front View**

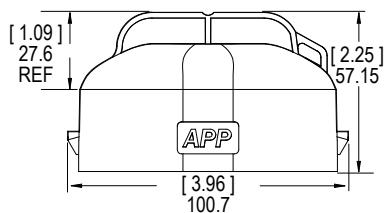

**Side View**

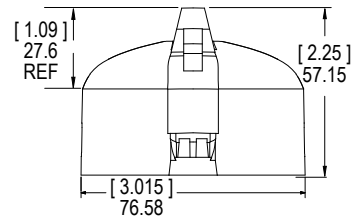

# Tooling Charts

## APPLICATION TOOLING

### PP75 Contact Tools

Contact Part Number	+ Hand Tool	or Pneumatic Bench Tool	+ Die	+ Locator
5900	1309G4	1387G1	1388G6	1389G6
5952			1388G7	1388G7
5915				

### PP120 Contact Tools

Contact Part Number	Dieless Hydraulic Tool	or Pneumatic Bench Tool	+ Die	+ Locator
1319	1368	1387G1		
1319G4			1388G4	1389G4
1319G6				
1323G1			1388G3	1389G3
1323G2				

### PP180 Contact Tools

Contact Part Number	Dieless Hydraulic Tool	or Pneumatic Bench Tool	+ Die	+ Locator	
1382	1368	1387G1	1387G2	1303G4	1304G32
1383			1388G3	1389G3	
1348					
1347					
1384			1388G5	1389G5	
1328G1			1303G4	1304G32	
1328G2	1387G2	1303G12			

### PowerMod® Signal Contact Tools

Contact Part Number	APP Hand Tool	or Mil Std. Hand Tool (APP Part #)	or Locator / Turret	or Pneumatic Tool for Locator / Turret
Crimp Pins PM16P12S30 PM16P1416S30 PM16P1620S30 PM16P2024S30	PM1000G1	M22520/1-01 (TM0001)	No Mil Std. (TL0001)	TP0001
Crimp Sockets PM16S12S32 PM16S1416S32 PM16S1620S32 PM16S2024S32			No Mil Std. (TL0002)	



1309



PM1000G1



TM0001



1368



NOTE: Visit [www.andersonpower.com](http://www.andersonpower.com) for additional tooling options.

All Data Subject To Change Without Notice Patents with Patents Pending

DS-HPSPAK REV00

**HEADQUARTERS:** Anderson Power Products®, 13 Pratts Junction Road, Sterling, MA 01564-2305 USA T:978-422-3600 F:978-422-3700

**EUROPE:** Anderson Power Products® Ltd., Unit 3, Europa Court, Europa Boulevard, Westbrook, Warrington, Cheshire, WA5 7TN United Kingdom T: +44 (0) 1925 428390 F: +44 (0) 1925 520203

**ASIA / PACIFIC:** IDEAL Anderson Asia Pacific Ltd., Unit 922-928 Topsail Plaza, 11 On Sum Street, Shatin N.T., Hong Kong T: +(852) 2636 0836 F: +(852) 2635 9036

**CHINA:** IDEAL Anderson Technologies (Shenzhen) Ltd., Block A8 Tantou Western Industrial Park, Songgang Baoan District, Shenzhen, P.R. China 518105 T: +(86) 755 2768 2118 F: +(86) 755 2768 2218

**TAIWAN:** IDEAL Anderson Asia Pacific Ltd., Taiwan Branch, 4F-2, No.116, Dadun 20th St., Situn District, Taichung City 407, Taiwan (R.O.C.) T: +(886) 4 2310 6451 F: +(886) 4 2310 6460

[www.andersonpower.com](http://www.andersonpower.com)