

# Powerpole® Connectors

## - PP120: up to 240 Amps

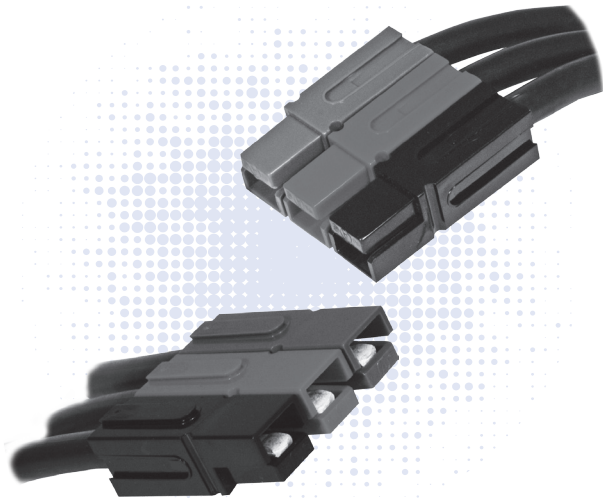

PP120 series Powerpole® housings are designed to accommodate up to 1/0 (50 mm<sup>2</sup>) wires and handle high currents up to 240 amps. Reducing bushings allow PP120 to accept down to #8 (10 mm<sup>2</sup>) wires. Multiple colors of stackable housings combine with low resistance flat wiping technology to offer powerful connection capability.

- **Large Wire Range Accommodates up to 1/0 (50mm<sup>2</sup>) Wire**  
*Reducing bushings allow as small as #8 (10 mm<sup>2</sup>) wire to be used*
- **Low Resistance Silver Plated Copper Contacts**  
*Allows currents up to 240 amps*
- **UL Rated for Hot Plugging up to 60 Amps**  
*Great for battery or other applications where the ability to interrupt circuits is required*

### | PP120 ORDERING INFORMATION |

#### PP120 Housings

The second to largest Powerpole® housing can be used with wire contacts for up to 1/0 AWG [50mm<sup>2</sup>] or busbar contacts.

Description	----- Part Numbers -----	
Minimum Quantity ...	500	50
Red	1321G3-BK	1321G3
Green	1321G4-BK	1321G4
Black	1321G1-BK	1321G1
White	1321G2-BK	1321G2
Blue	1321-BK	1321
Gray	1321G8-BK	1321G8

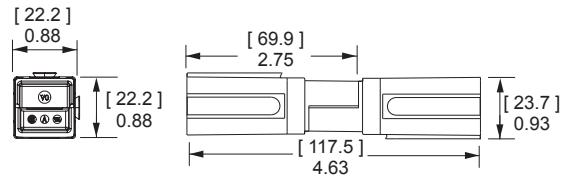

#### PP120 Silver Plated Wire Contacts

Silver plated contacts offer superior electrical performance and durability up to 10,000 mating cycles. New contacts for #1 to 1/0 AWG (35 to 50 mm<sup>2</sup>) offer extended capability in the same housings. See reducing bushings in accessory section for smaller wires.

AWG	mm <sup>2</sup>	Mating Force	----- Loose Piece Part Numbers -----		- A -		- B -		
			600	500	inches	mm	inches	mm	
1/0	53.5	Low	1323G2-BK	-	1323G2	0.52	13.21	0.44	11.18
1	42.4	Low	1323G1-BK	-	1323G1	0.47	11.94	0.39	9.91
2	33.6	High	-	1319-BK	1319	0.44	11.18	0.34	8.64
4	21.1	High	-	1319G4-BK	1319G4	0.44	11.18	0.29	7.37
6	13.3	High	-	1319G6-BK	1319G6	0.44	11.18	0.22	5.59

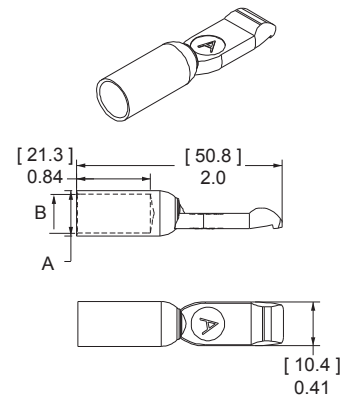

# PP120 SPECIFICATIONS

Electrical		
<b>Current Rating Amperes <sup>1</sup></b>	<b>UL 1977</b>	<b>CSA</b>
Singlepole UL 1977 (1/0 AWG)	240	155
2x2 Block UL 1977 (1/0 AWG)	200	110
<b>Voltage Rating AC/DC</b>		
UL 1977	600	
<b>Dielectric Withstanding Voltage</b>		
Volts AC	2,200	
<b>Avg. Mated Contact Resistance Milliohms <sup>1</sup></b>		
5 1/2" of #2 AWG wire	0.136	
<b>UL Hot Plug Current Rating Amperes <sup>4</sup></b>		
250 cycles at 120V DC	60A	

Materials	
<b>Housing</b>	
Plastic Resin	Polycarbonate
Contact Retention Spring	Stainless Steel
<b>Housing Flammability Rating</b>	
UL94	V-0
Glow Wire	960°C (GWFI) / 850°C (GWIT)
<b>Contact</b>	
Base	Copper Alloy
Plating	Silver
<b>Contact Termination Methods</b>	
Crimp <sup>3</sup>	Wire Contacts
Hand Solder	Wire Contacts

Mechanical		
<b>Wire Size Range</b>	<b>AWG</b>	<b>mm<sup>2</sup></b>
Wire Contacts with Bushings	10 to 1/0	5.3 to 53.5
<b>Max. Wire Insulation Diameter</b>	<b>in.</b>	<b>mm</b>
	0.600	15.240
<b>Operating Temperature <sup>2</sup></b>	<b>°F</b>	<b>°C</b>
	-4° to 221°	-20° to 105°
<b>Mating Cycles No Load by Plating</b>	<b>Silver (Ag)</b>	
Wire Contacts	10,000	
<b>Avg. Mating / Unmating Force</b>	<b>Lbf.</b>	<b>N</b>
	8	36
<b>Min. Contact / Spring Retention Force</b>	<b>Lbf.</b>	<b>N</b>
	60	267

NOTE 1: See IEC 60664-1 for working voltage.

NOTE 2: Amp ratings are stated per position and based on all positions being fully loaded.

<sup>1</sup> Based on: 105°C rated or better cable of the largest size, Properly calibrated APP recommended tooling, and a 25°C ambient temperature. UL rating not to exceed the maximum operating temperature. CSA rating below a 30°C temperature rise.

<sup>2</sup> Limited by the thermal properties of the connector plastic housing.

<sup>3</sup> Use APP recommended tooling only. Alternate tools may adversely affect the performance of our connectors along with UL and CSA recognition.

<sup>4</sup> Based on 2 housings blocked together.



## IEC INFORMATION

Connector Series	Configurations		Creepage / Clearance per IEC 60950-1	Material Group
PP120	Single Pole	Unmated	4.36 mm	IIIa
		Mated	4.36 mm	
	Stacked Powerpole®	Unmated	4.36 mm	
		Mated	4.36 mm	

Attributes	PP120
AMP Rating AC/DC	120
Voltage Rating AC/DC (Steady State)	400 V AC/DC ( Operational)
Breaking Capacity -AMP Rating /Cycles	120 Amp / 10 Cycles
Voltage Rating (Breaking Capacity)	220 VDC
FINGER Safety - Mated only	IEC 60529 - IP20
Wire Size tested	50 mm <sup>2</sup>
Contact Series Tested	1323G2
Climatic Testing (Cold,Heat & MFG)	IEC 60512 Test -11j, 11i & 11g,
Cycle Life	IEC 60512 Test 9a - 5000 Cycles
Mechanical Strength Impact	IEC 60512-5 @ 29.5 Inches - dropped 8 times
Temperature Range	-20 °C to 105 °C -4 °F to 221 °F

Protection
<b>Touch Safety with Wire Contacts</b>
IEC 60529 IP10



NOTE 3: Refer to the Constructional Data form for additional information on our website., [www.andersonpower.com](http://www.andersonpower.com)

# PP120 TEMPERATURE CHARTS | Temperature rise charts are based on a 25°C ambient temperature.

For Temperature Rise Above 60°C, Consult the Extended Temperature Rise Charts in the Appropriate Product Section on the Website.

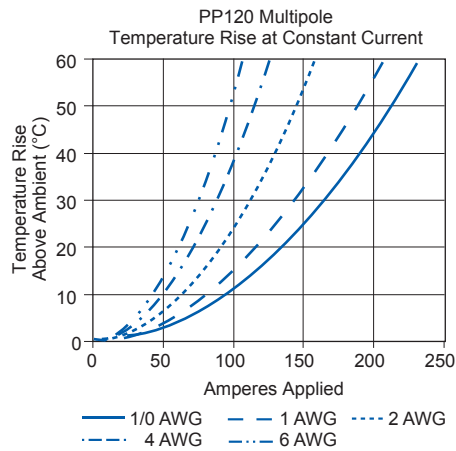
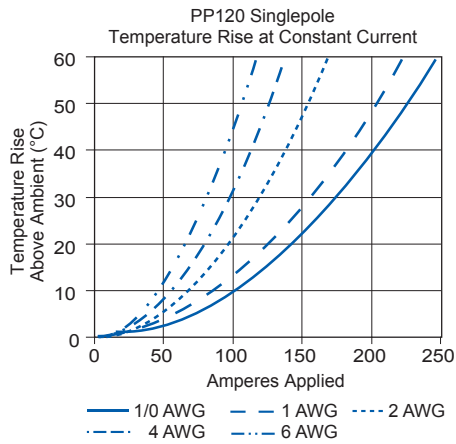

Current - Temperature Derating per IEC 60512-5-2 Test 5B

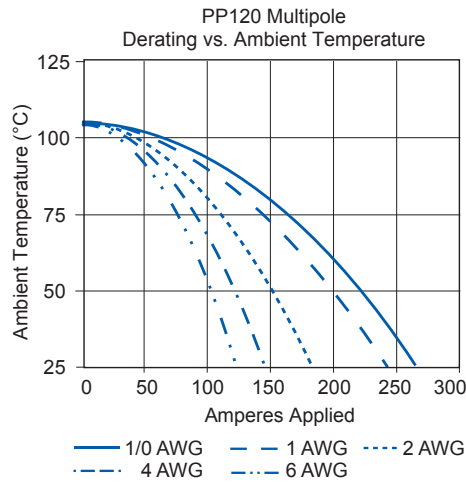
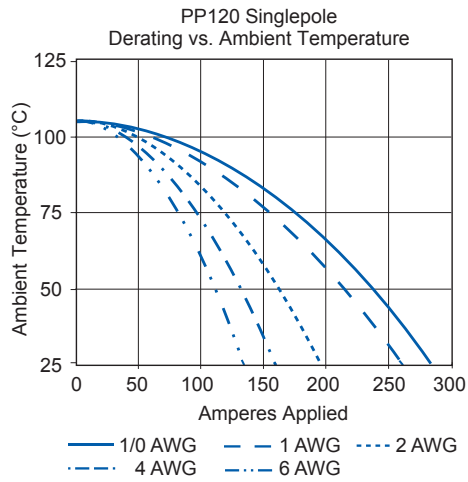

# | POWERPOLE® PP120 ACCESSORIES |

## Mounting Clamp

Mounting clamps can be used for fastening a block of Powerpole® 120 series housings to a panel. Connector blocks must be a complete square for the clamps to work properly. Fastening hardware not included.

Description	- Part Numbers -
Minimum Quantity ...	20 sets of 2 .....
2 Pole	1464G1
3 Pole	1464G2

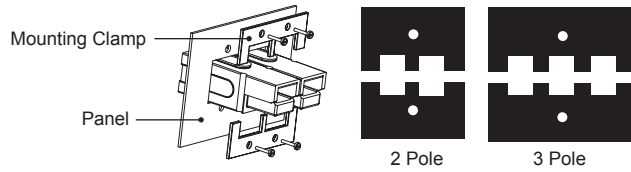

## Retaining Pins

Retaining pins are used to keep stacked Powerpole® 120 series housings from separating. Retaining pins are inserted in the circular opening between two housings stacked side by side. Dimension B is +/- 0.015 in or 0.38 mm.

Description	Part Numbers		Dimensions			
			- A -		- B -	
	inches	mm	inches	mm		
Minimum Quantity ...	1,000	100				
1 Block High	111812P7	110G19	0.196 / 0.207	4.98 / 5.26	0.560	14.220
2 Block High	111812P8	110G20	0.196 / 0.207	4.98 / 5.26	1.500	38.100

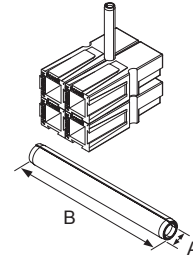

## Reducing Bushings

Use with contact part number 1319-BK to allow a smaller wire to be used with the connector. Electrical capability is derated with smaller wire.

Contact Barrel Size	Wire Size	Part Numbers			Dimensions - ID -	
		inches	mm	inches	mm	
Minimum Quantity		2,000	1,000	100		
#2 AWG [33.6 mm <sup>2</sup> ]	#4 AWG [21.2 mm <sup>2</sup> ]	5919-BK	-	5919	0.28	7.11
#2 AWG [33.6 mm <sup>2</sup> ]	#6 AWG [16 mm <sup>2</sup> ]	-	5920-BK	5920	0.23	5.84
#2 AWG [33.6 mm <sup>2</sup> ]	#10 - 8 AWG [5.3 - 8.4 mm <sup>2</sup> ]	5921-BK	-	5921	0.18	4.57

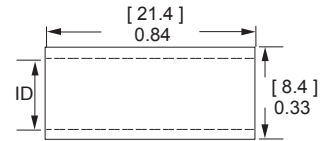

For environmentally sealed connector shells to hold Powerpole® 15-180 connectors, see SPEC Pak® product series on our website, [www.andersonpower.com](http://www.andersonpower.com)



# Powerpole®

## - Tooling Information

Wire Size		Reeled Part Numbers		Reeled Contact Crimp Tool	
AWG	mm²	Tin Plating	Silver Plating	APP Applicator +	APP Press
<b>PP15 / 45 Flat Wiping Power &amp; Ground</b>					
#16 / 20	1.3 / 0.52	262G1	262G2	TD0101	115V= TE0101 230V = TE0102
#16 / 20	1.3 / 0.52	269G2	N/A		
#12 / 16	3.3 / 1.3	261G1	N/A		
#10 / 14	5.3 / 2.1	261G2	261G3		
#12 / 16	3.3 / 1.3	269G1	N/A		
#10 / 14	5.3 / 2.1	269G3	N/A		
#10 / 14	5.3 / 2.1	200G1L	200G3L	TD0102	
#10 / 14	5.3 / 2.1	201G1H	N/A		
#10 / 14	5.3 / 2.1	1830G1	1830G2		

\* APP applicators are mechanical feed style and do not require an air feed kit.

Wire Size		Loose Piece Part Numbers		Loose Piece Contact Crimp Tool				
AWG	mm²	Tin Plating	Silver Plating	Hand Tool Or	Pneumatic Bench Tool +	Die +	Locator	Number of Crimps
<b>PP15 / 45 Flat Wiping Power &amp; Ground</b>								
#16 / 20	1.3 / 0.52	N/A	1332	1309G2 or 1309G8	N/A	N/A	N/A	Single
#12 / 16	3.3 / 1.3	N/A	1331					
#16 / 20	1.3 / 0.52	262G1-LPBK	262G2-LPBK					
#16 / 20	1.3 / 0.52	269G2-LPBK	N/A	1309G3 or 1309G8	N/A	N/A	N/A	Single
#12 / 16	3.3 / 1.3	261G1-LPBK	N/A					
#10 / 14	5.3 / 2.1	261G2-LPBK	261G3-LPBK					
#12 / 16	3.3 / 1.3	269G1-LPBK	N/A	1309G6 or 1309G8	N/A	N/A	N/A	Single
#10 / 14	5.3 / 2.1	269G3-LPBK	N/A					
#10 / 14	5.3 / 2.1	200G1L-LPBK	200G3L-LPBK					
#10 / 14	5.3 / 2.1	201G1H-LPBK	N/A	1309G6 or 1309G8	N/A	N/A	N/A	Single
310 / 14	5.3 / 2.1	1830G1-LPBK	1830G2-LPBK					
<b>PP75</b>								
#6	13.3	N/A	1307	1309G4	1387G1	1388G6	1389G6	Single
			5900				1389G21	
#8	8.4		1875G1				1389G6	
			5952				1389G21	
			1875G2				1389G6	
			5953				1389G21	
#10 / 12	5.3 / 3.3		5915				1389G6	
			1875G3				1389G21	
<b>PP120</b>								
1/0	53.5	N/A	1323G2	1368 Series	1387G1	1388G3	1389G4	Single
#1	42.4		1323G1					
#2	33.6		1319					
#4	21.2		1319G4					
#6	13.3		1319G6					
<b>PP180</b>								
3/0	85	N/A	1328G2	1368 Series	1387G2	1303G12	1304G32	Double
2/0	53.5		1328G1					
1/0	53.5		1382					
#1	42.4		1347					
#2	33.6		1383					
#4	21.1		1384					
#6	13.3		1348					
						1387G1		

- NOTE: See website for the most current information.
- NOTE: Insertion / Extraction tool for PP15/45 contacts = 111038G2