

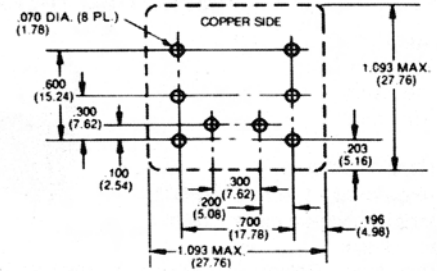

1360PC/1365PC SERIES - DPDT

- DPDT (2C)
- Rated: 5 amps at 30 VDC and 120 VAC Resistive load, 1/8 H.P., 120 VAC
- Termination suitable for socket or Printed circuit
- Standard/stock AC coil voltages 24, 120
- Standard/stock DC coil voltage 12, 24
- Sockets available
- Weight 1 oz. (28 grams)

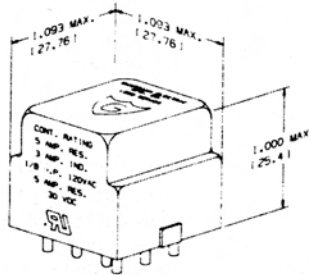

5 AMPS

Coil Voltage	Coil Res. Ω	PART NUMBERS
24 VAC	150	1360PC-2C-24A
120 VAC	3500	1360PC-2C-120A
12 VDC	150	1365PC-2C-12D
24 VDC	600	1365PC-2C-24D

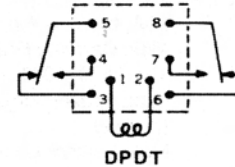

1330/1335 SERIES - DPDT

- DPDT (2C)
- Rated: 5 amps at 30 VDC & 120 VAC Resistive load; 3 amps at 120 VAC Inductive load; 1/8 H.P., 120 VAC.
- Sealed versions 1330S & 1335S
- Plug in/solder lug terminals 1330 & 1335
- Printed circuit terminals 1330P & 1335P
- Standard/stock AC coil voltages (1330) 12, 24, 120
- Standard/stock DC coil voltages (1335) 12, 24
- Sockets available
- Weight .75 oz. (21 grams)

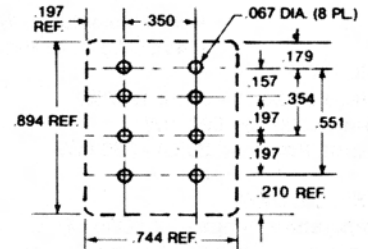
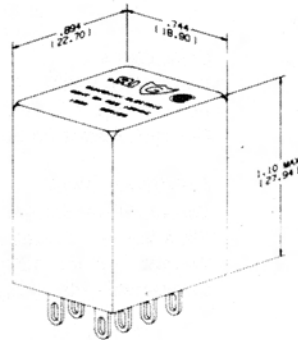

5 AMPS

Coil Voltage	Coil Res. Ω	PART NUMBERS		
		Plug In	P.C.	P.C. Sealed
12VAC	49.5	1330-2C-12A	1330P-2C-12A	1330PS-2C-12A
24VAC	245	1330-2C-24A	1330P-2C-24A	1330PS-2C-24A
120VAC	5400	1330-2C-120A	1330P-2C-120A	1330PS-2C-120A
12VDC	125	1335-2C-12D	1335P-2C-12D	1335PS-2C-12D
24VDC	500	1335-2C-24D	1335P-2C-24D	1335PS-2C-24D

CIRCUIT DIAGRAM

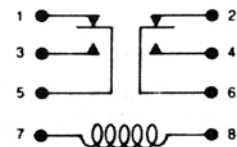

1310/1315 SERIES - DPDT & 4 PDT

- 4PDT (4C) or DPDT (2C)
- Rated: 5 amps at 30 VDC & 120 VAC Resistive load, 3 amps at 120 VAC Inductive load; 1/8 H.P., 120 VAC.
- Sealed versions 1310PS, 1315PS
- Plug in/solder lug terminals 1310, 1315
- Printed circuit terminal 1310P, 1315P
- Standard/stock AC coil voltages (1310) 12, 24, 120
- Standard/stock DC coil voltages (1315) 12, 24, 110
- Sockets available
- Weight 1.52 oz. (43 grams)

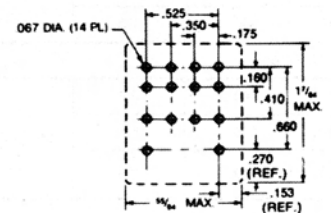
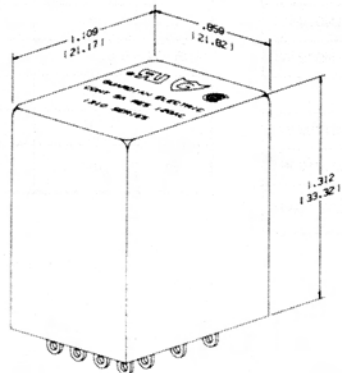

5 AMPS

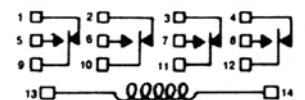

4PDT

Coil Voltage	Coil Res. Ω	PART NUMBERS		
		Plug In	P.C.	P.C. Sealed
12VAC	45	1310-4C-12A	1310P-4C-12A	1310PS-4C-12A
24VAC	160	1310-4C-24A	1310P-4C-24A	1310PS-4C-24A
120VAC	3900	1310-4C-120A	1310P-4C-120A	1310PS-4C-120A
12VDC	160	1315-4C-12D	1315P-4C-12D	1315PS-4C-12D
24VDC	650	1315-4C-24D	1315P-4C-24D	1315PS-4C-24D
110VDC	11000	1315-4C-110D	1315P-4C-110D	1315PS-4C-110D

DPDT

Coil Voltage	Coil Res. Ω	PART NUMBERS	
		Plug In	P.C.
12VAC	45	1310-2C-12A	1310P-2C-12A
24VAC	160	1310-2C-24A	1310P-2C-24A
120VAC	3900	1310-2C-120A	1310P-2C-120A
12VDC	160	1315-2C-12D	1315P-2C-12D
24VDC	650	1315-2C-24D	1315P-2C-24D
110VDC	11000	1315-2C-110D	1315P-2C-110D



7 RELAYS

1565 SERIES - SPDT

- SPST-NO (1A) and SPDT (1C)
- **Rated:**
6 amps at 120 VAC Resistive load
3 amps at 30 VDC & 240 VAC Resistive load
1/3 H.P. at 120 VAC
- **Sealed version available 1565S**
- Printed circuit termination
- Standard/stock D.C. coil voltages 6, 12, 24
- Weight .43 oz. (12 grams)

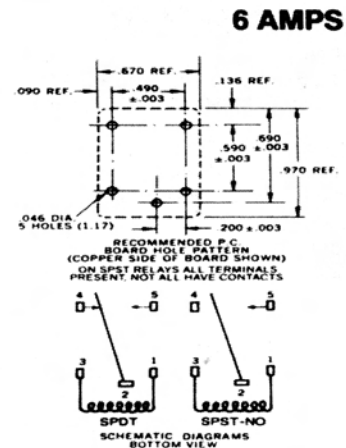
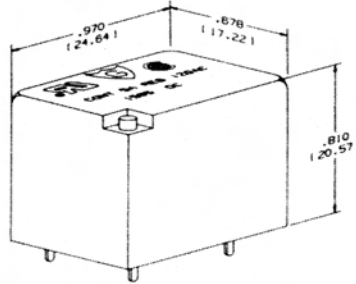

Coil Voltage	Coil Res. Ω	PART NUMBERS			
		Unsealed		Sealed	
		SPST-NO	SPDT	SPST-NO	SPDT
6VDC	45	1565-1A-6D	1565-1C-6D	1565S-1A-6D	1565S-1C-6D
12VDC	180	1565-1A-12D	1565-1C-12D	1565S-1A-12D	1565S-1C-12D
24VDC	720	1565-1A-24D	1565-1C-24D	1565S-1A-24D	1565S-1C-24D

1345 SERIES - SPST & SPDT

- SPST-NO (1A) and SPDT (1C)
- **Rated:**
10 amps at 12 VDC, 120 VAC Resistive load.
5 amps at 30 VDC, 240 VAC Resistive load.
- **Sealed version 1345S**
- Termination printed circuit
- Standard/stock D.C. coil voltages 12 and 24
- Weight 1.0 oz. (28 grams)

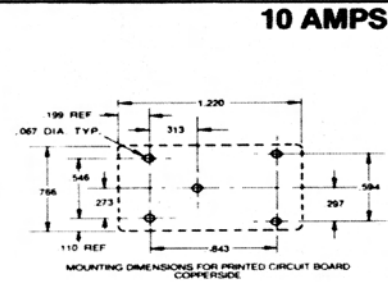
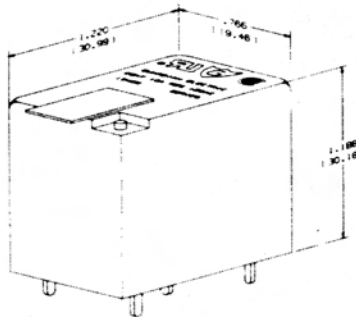

Coil Voltage	Coil Res. Ω	PART NUMBERS			
		Unsealed		Sealed	
		SPST-NO	SPDT	SPST-NO	SPDT
12VDC	1400	1345-1A-12D	1345-1C-12D	1345S-1A-12D	1345S-1C-12D
24VDC	5600	1345-1A-24D	1345-1C-24D	1345S-1A-24D	1345S-1C-24D

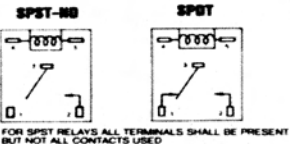

1390/1395 SERIES - DPDT

- DPDT (2C)
- **Rated:**
13 amps at 30 VDC, 120/240 VAC Resistive load. 1/3 H.P. at 120/240 VAC
- **Sealed versions 1390VS, 1390PVS, 1395VS, 1395PVS**
- Plug in/solder lug terminals 1390, 1395
- Printed circuit terminals 1390P, 1395P
- Standard/stock A.C. coil voltages 12, 24, 120
- Standard/stock D.C. coil voltages 12, 24, 110
- Sockets available
- Flange mount cover available
- Weight 1.52 oz. (43 grams)

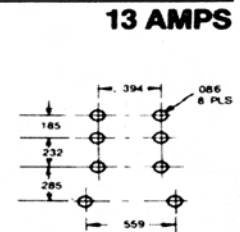
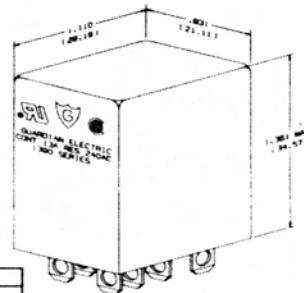

Coil Voltage	Coil Res. Ω	PART NUMBERS					
		Plug In			P.C.		
		Unsealed	Sealed	Unsealed	Sealed		
12VAC	45	1390-2C-12A	1390VS-2C-12A	1390P-2C-12A	1390PVS-2C-12A		
24VAC	180	1390-2C-24A	1390VS-2C-24A	1390P-2C-24A	1390PVS-2C-24A		
120VAC	3900	1390-2C-120A	1390VS-2C-120A	1390P-2C-120A	1390PVS-2C-120A		
12VDC	160	1395-2C-12D	1395VS-2C-12D	1395P-2C-12D	1395PVS-2C-12D		
24VDC	650	1395-2C-24D	1395VS-2C-24D	1395P-2C-24D	1395PVS-2C-24D		
110VDC	11000	1395-2C-110D	1395VS-2C-110D	1395P-2C-110D	1395PVS-2C-110D		

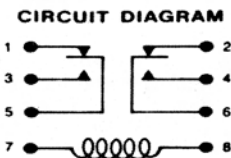

1735 Series-SPST

- SPST-NO (1A)
- **Rated:** 30 AMPS at 240VAC TV 15 at 120VAC
- .250" Q.C. Terminals 1735Q
- Printed Circuit Terminals 1735P
- Standard Stock D.C. Coil Voltages 6, 12 & 24
- Flange mount cover

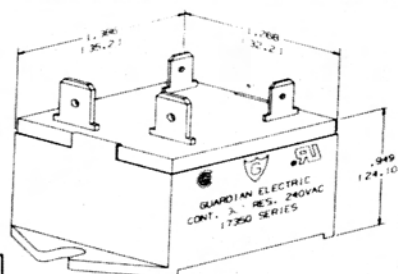

30 AMPS

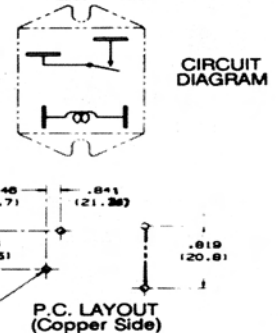

Coil Voltage	Coil Res.	PART NUMBERS	
		P.C.	Q.C.
		6VDC	30
12VDC	120	1735P-1A-12D	1735Q-1A-12D
24VDC	480	1735P-1A-24D	1735Q-1A-24D



1575 SERIES - SPDT

- SPDT (1C)
- Rated: 5 amps at 30 VDC and 240 VAC
Resistive load. 1/10 H.P. at 120 VAC

- Sealed version 1575S
- Printed circuit termination
- Standard/stock D.C. coil voltages 6, 12, 24
- Weight .5 oz. (14 grams)

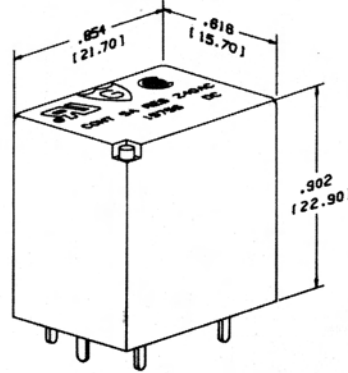

5 AMPS

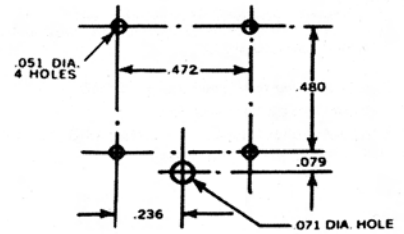

P.C. LAYOUT (COPPER SIDE)

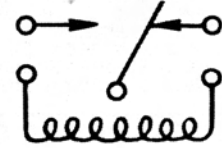

SCHEMATIC DIAGRAM
BOTTOM VIEW

Coil Voltage	Coil Res. Ω	PART NUMBERS	
		Unsealed	Sealed
6VDC	100	1575-1C-6D	1575S-1C-6D
12VDC	400	1575-1C-12D	1575S-1C-12D
24VDC	1600	1575-1C-24D	1575S-1C-24D

1725 SERIES - SPDT

- SPDT (1C)
- Rated: 5 amps at 30 VDC/120 VAC/240 VAC
Resistive load. 1/10 H.P., 120 VAC.
5 amp Tungsten 120 VAC

- Sealed version 1725S
- Printed circuit termination
- Standard/stock D.C. coil voltages 6, 12, 24
- Weight 1 oz. (28 grams)



New 10 Amp Rating
SPST-1A Version

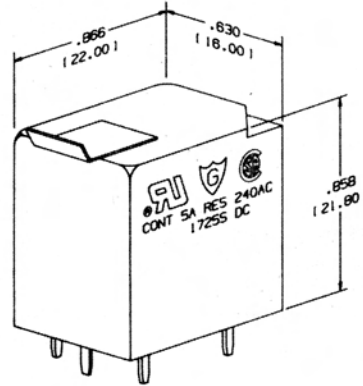

5 AMPS

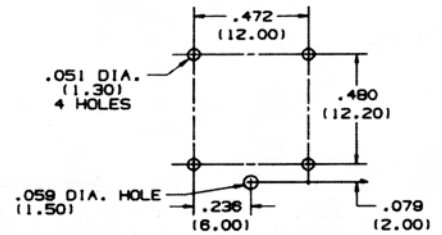

P.C. LAYOUT (COPPER SIDE)

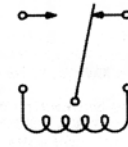

CIRCUIT
DIAGRAM

Coil Voltage	Coil Res. Ω	PART NUMBERS	
		Unsealed	Sealed
6VDC	100	1725-1C-6D	1725S-1C-6D
12VDC	400	1725-1C-12D	1725S-1C-12D
24VDC	1600	1725-1C-24D	1725S-1C-24D

1665 SERIES - DPDT

- DPDT (2C)
- Rated: 5 amps at 30 VDC, 120/240 VAC
Resistive load; 5 amp Tungsten - 120 VAC; TV5 - 120 VAC
1/6 H.P. at 120 VAC;
1/3 H.P. at 240 VAC

- Sealed version 1665S
- Stock/standard D.C. coil voltages 6, 12, 24
- Weight .53 oz. (15 grams)



Now VDE Approved

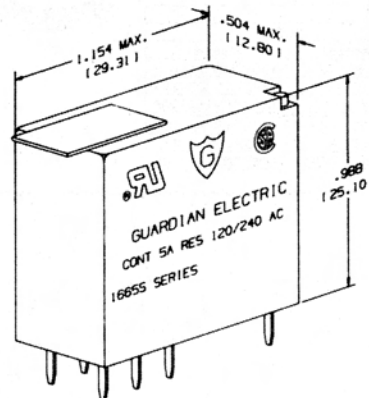

5 AMPS

PRINTED CIRCUIT BOARD LAYOUT
(COPPER SIDE)

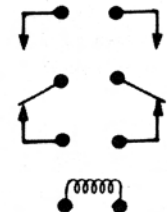
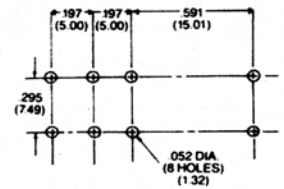

Coil Voltage	Coil Res. Ω	PART NUMBERS	
		Unsealed	Sealed
6VDC	68	1665-2C-6D	1665S-2C-6D
12VDC	275	1665-2C-12D	1665S-2C-12D
24VDC	1100	1665-2C-24D	1665S-2C-24D



1495 SERIES - DPDT

- DPDT (2C) crossbar
- Rated: 2 amps at 120 VAC Resistive load.
1 amp at 30 VDC/120 VAC Resistive load
- **Sealed version 1495S**
- Printed circuit termination on .100" grid
- Standard/stock DC coil voltages 5, 6, 12, 24
- Meets FCC part 68 1500 volt surge test
- Weight .18 oz. (5 grams)

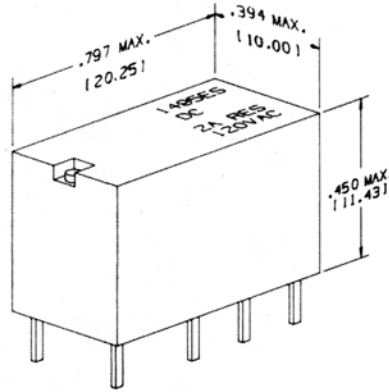

2 AMPS

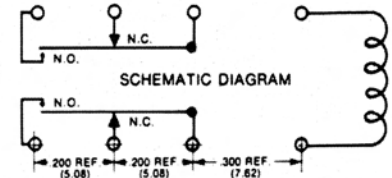
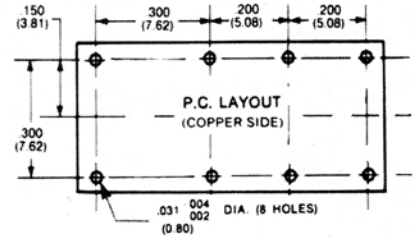

Coil Voltage	Coil Res. Ω	PART NUMBERS	
		Unsealed	Sealed
5VDC	36	1495-2C-5D	1495S-2C-5D
6VDC	70	1495-2C-6D	1495S-2C-6D
12VDC	280	1495-2C-12D	1495S-2C-12D
24VDC	1050	1495-2C-24D	1495S-2C-24D

1675 SERIES - SPDT

- SPDT (1C)
- Rated: 5 amps at 30 VDC and 240 VAC Resistive load. 1/10 H.P. 120 VAC
- **Sealed version 1675S**
- Printed circuit termination
- Standard/stock DC coil voltages 5, 6, 12, 24
- Weight .27 oz. (8 grams)

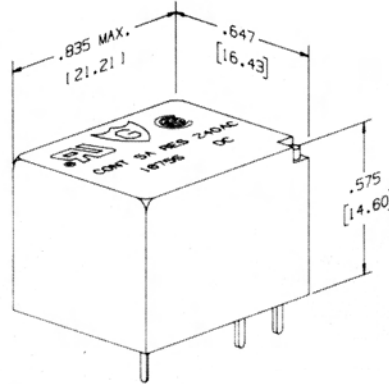

5 AMPS

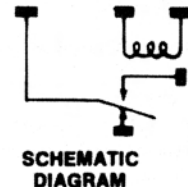
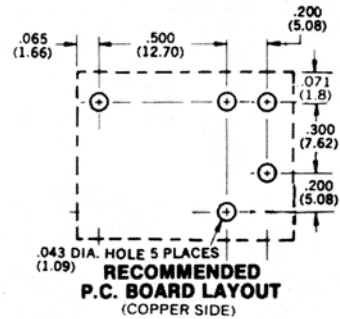

Coil Voltage	Coil Res. Ω	PART NUMBERS	
		Unsealed	Sealed
5VDC	56	1675-1C-5D	1675S-1C-5D
6VDC	80	1675-1C-6D	1675S-1C-6D
12VDC	320	1675-1C-12D	1675S-1C-12D
24VDC	1280	1675-1C-24D	1675S-1C-24D



1715 SERIES - SPST & SPDT

- SPST-NO (1A) SPDT (1C)
- SPST Rated:
 - 10 amps at 30 VDC, 120 VAC Resistive load.
 - 5 amps at 240 VAC Resistive load.
 - 1/4 H.P. at 120 VAC
- SPDT Rated:
 - 10 amps at 30 VDC/240AC Resistive load.
 - 5 amps at 30 VDC/240AC Resistive load.
 - 6 amps at 120 VAC Resistance load.
 - 1/10 H.P. at 120 VAC
- Sealed version 1715S
- Printed circuit terminals
- Standard/stock D.C. coil voltages 6, 12, 24
- Weight .5 oz. (14 grams)

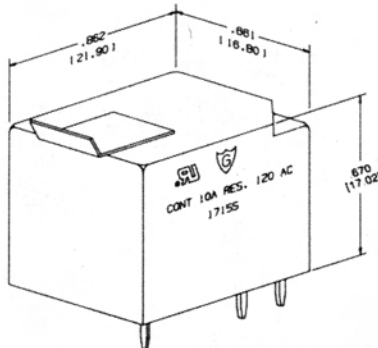

10 AMPS

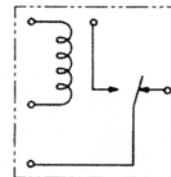
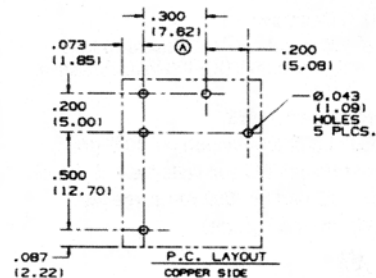

WIRING DIAGRAM



Coil Voltage	Coil Res. Ω	PART NUMBERS			
		Unsealed		Sealed	
		SPST-NO	SPDT	SPST-NO	SPDT
6VDC	80	1715-1A-6D	1715-1C-6D	1715S-1A-6D	1715S-1C-6D
12VDC	320	1715-1A-12D	1715-1C-12D	1715S-1A-12D	1715S-1C-12D
24VDC	1280	1715-1A-24D	1715-1C-24D	1715S-1A-24D	1715S-1C-24D

New TV-5 Rating SPST-NO (1A)

1655 SERIES - SPST-NO & SPDT

- SPST-NO (1A) SPDT (1C)
- Rated:
 - 10 amps 30 VDC, 120 & 240 VAC Resistive load.
 - 7 amps Tungsten 120 VAC (TV 7)
 - 1/3 H.P. at 120 VAC
 - 1/2 H.P. at 240 VAC
- Sealed version 1655S
- Termination printed circuit
- Standard/stock D.C. coil voltages 6, 12, 24
- Weight .53 oz. (15 grams)

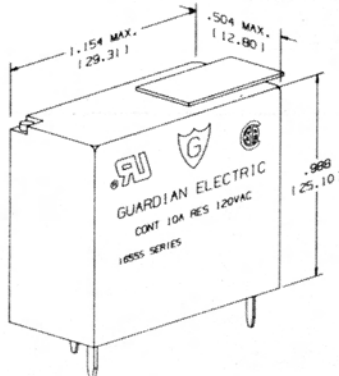

New 16 Amp & TV 8 Rating SPST-1A Version

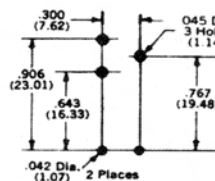

RECOMMENDED PC BOARD LAYOUT (COPPER SIDE)

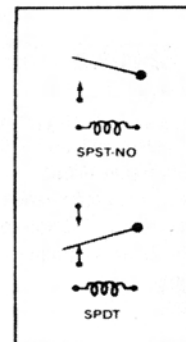

WIRING DIAGRAMS



Now VDE Approved

Coil Voltage	Coil Res. Ω	PART NUMBERS			
		Unsealed		Sealed	
		SPST-NO	SPDT	SPST-NO	SPDT
6VDC	68	1655-1A-6D	1655-1C-6D	1655S-1A-6D	1655S-1C-6D
12VDC	275	1655-1A-12D	1655-1C-12D	1655S-1A-12D	1655S-1C-12D
24VDC	1100	1655-1A-24D	1655-1C-24D	1655S-1A-24D	1655S-1C-24D

1220/1225 SERIES - DPDT & 3PDT

- DPDT (2C) 3PDT (3C)
- Rated:
 - 10 amps at 120 VAC Resistive load.
 - 1/4 H.P. at 120 VAC
- Plug in / solder lug terminals
- Standard/stock A.C. coil voltages 24, 120, 240
- Standard/stock D.C. coil voltages 12, 24, 110
- Sockets available
- Weight 3 oz. (85 grams)

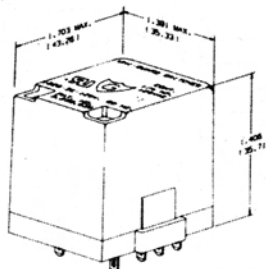

10 AMPS

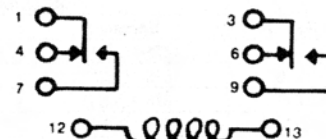

DPDT CIRCUIT DIAGRAM

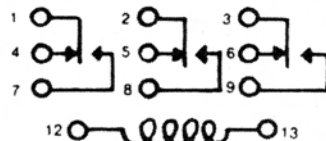

3PDT CIRCUIT DIAGRAM



7 amps

Coil Voltage	Coil Res. Ω	PART NUMBERS	
		DPDT	3PDT
		24VAC	54
120VAC	1110	1220-2C-120A	1220-3C-120A
240VAC	5000	1220-2C-240A	1220-3C-240A
12VDC	75	1225-2C-12D	1225-3C-12D
24VDC	300	1225-2C-24D	1225-3C-24D
110VDC	6500	1225-2C-110D	1225-3C-110D