

C&K NE-18 Series Mains / Power Switches



Features/Benefits

- Chassis or panel mount
- Various buttons
- Various contact configurations
- RoHS compliant

Typical Applications

- Mains/power switching
- Consumer electronics
- Audio equipment
- Digital products

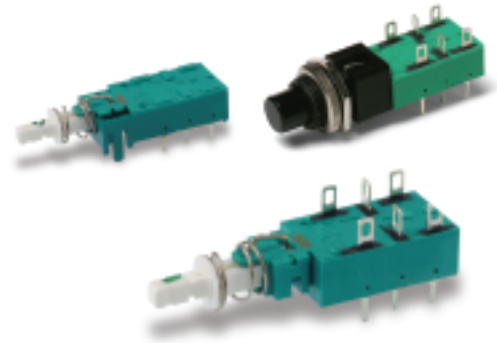

Specifications

POWER CONTACT:

SWITCHING POWER MAX. AC/DC: NE18: 1500/100 W, NE18CTII: 1000/100 W; AC (Inductive $\cos \phi = 0.6$): NE18: 900W, NE18CTII: 600W.

SWITCHING VOLTAGE MAX. AC/DC: 250/100V

SWITCHING CURRENT MAX. AC/DC

AC (Inductive $\cos \phi = 0.6$): NE18: $6 A^2$ /1 A, NE18CTII: $4 A^2$ /1 A

INRUSH CURRENT MAX. AC¹): NE18: 36 A, NE18CTII: 64 A

DIELECTRIC STRENGTH (50 Hz, 1 min.): 2000 V

OPERATING LIFE AT MAX. LOAD AND AT MAX. INRUSH CURRENT: $\sim 10^4$ operations⁵)

CONTACT RESISTANCE: Initial: 50m Ω ; After 10^4 operations: 70m Ω .

INSULATION RESISTANCE: $\sim 10^{12}$ Ω chassis – nearest contact; $\sim 10^{12}$ Ω mains contact – mains contact; $\sim 10^{12}$ Ω mains contact – mains contact after 10^4 operations.

LOW VOLTAGE CONTACT:

SWITCHING POWER MAX.: 12W

SWITCHING VOLTAGE MAX.: 24V

SWITCHING CURRENT MAX.: 0.5A

TOTAL TRAVEL: 4.7mm (.185 inch)

LATCHING TRAVEL: 3.3mm (.130 inch)

OPERATING FORCE: Without auxiliary low voltage contacts:

NE18: 7N (700 grams); NE18CTII: 9.5N (950 grams).

With auxiliary low voltage contacts: NE18: 8N (800 grams);

NE18CTII: 11N (1100 grams).

SEALING: Dust proof.

Materials

HOUSING, ACTUATOR & TERMINAL BOARD: Thermoplastic polyester (UL 94V-0).

MOVABLE CONTACT: Silver nickel alloy, silver plated.

FIXED CONTACTS: Silver nickel alloy, silver plated.

COMMON CONTACTS & TERMINALS: Copper alloy, silver plated.

RETURN SPRING: Music wire.

NOTE: For the latest information regarding RoHS compliance, please go to: www.ittcannon.com/rohs. All models are RoHS compliant and compatible.

NOTE: Specifications and materials listed above are for switches with standard options. For information on specific and custom switches, consult Customer Service Center.

Build-A-Switch

To order, simply select desired option from each category and place in the appropriate box. Available options are shown and described on pages A-100 thru A-106. For additional options not shown in catalog, consult Customer Service Center.

If requesting only a switch, select the switch as noted below. Buttons are sold separately.

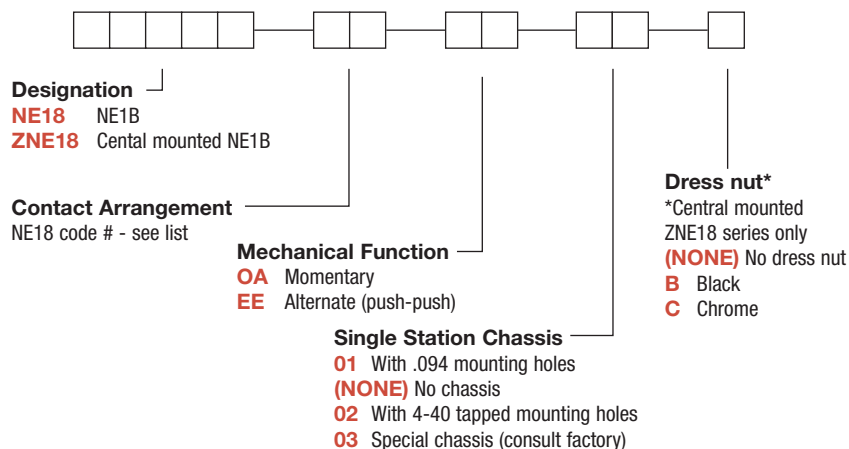



C&K NE-18 Series Mains / Power Switches

A

Pushbutton

Order Code - Buttons

Solid Buttons

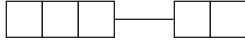

Style

- F01** FMR
- F02** FG*
- F12** FSC
- F13** FSD
- F14** FU12
- F15** FSB
- F16** FE
- F19** FA
- F21** F001

Button Color

- 01** Black
- 02** White
- 03** Red
- 04** Light gray

Mechanical Indicator Buttons

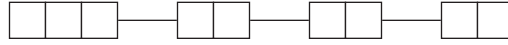

Style

- F01** FA100
- F02** FA101
- F07** FA120
- F08** FA201
- F11** FA200*

Shell Color

- 01** Black

Out Position Color

- 01** Black

In Position Color

- 02** White
- 06** Yellow
- 07** Blue
- 08** Green
- 12** Orange

*Button options for central mounting configurations, use 'FG' for central mount with chrome dress nut, use 'FA200' for central mount with black dress nut.

BUTTON REMOVAL

A button of a push-push switch should only be removed in the "OFF" non-latching position.

DESIGNATION & SWITCHES WITH STANDARD OPTIONS



NE1838EE

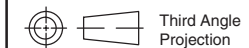
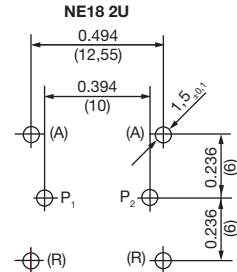
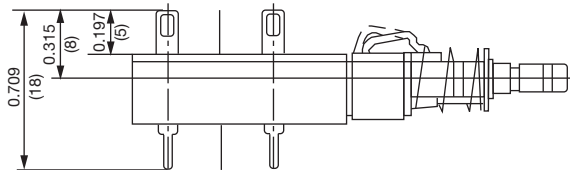
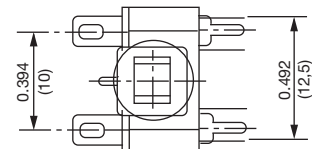
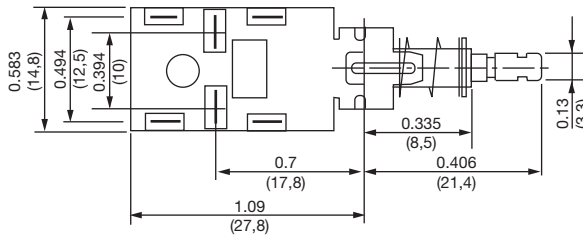
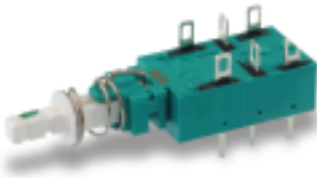

Dimensions are shown: Inches (mm)
Specifications and dimensions subject to change

C&K NE-18 Series Mains / Power Switches



A

Pushbutton

DESIGNATION & SWITCHES WITH STANDARD OPTIONS



NE1839EE

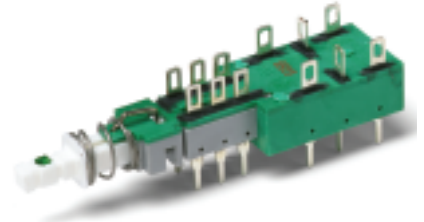
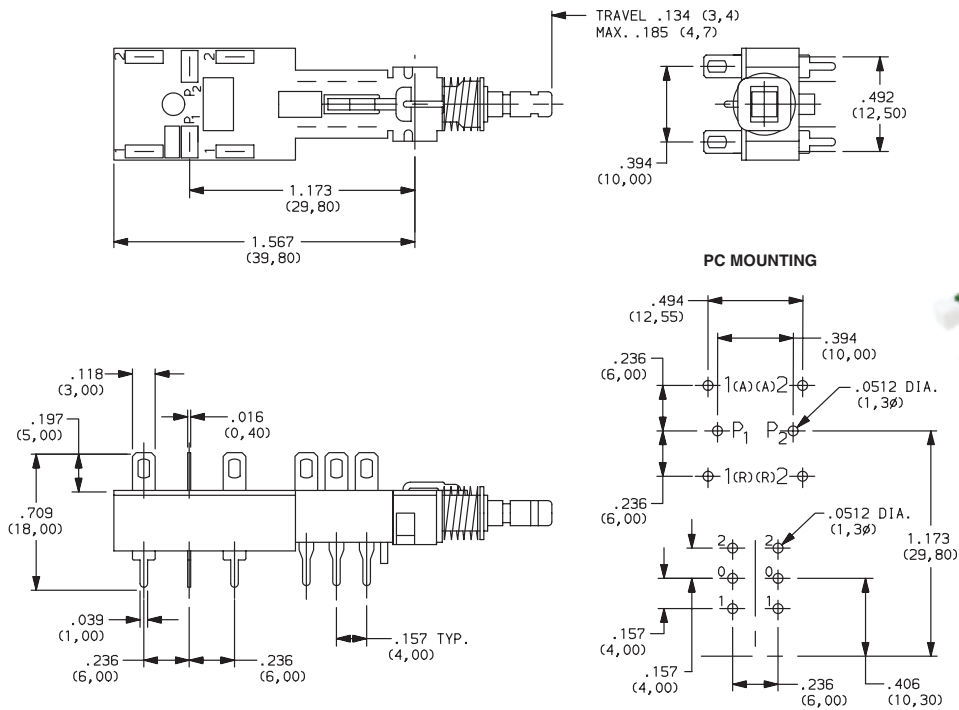

NE1848EE

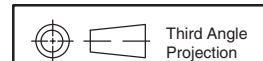
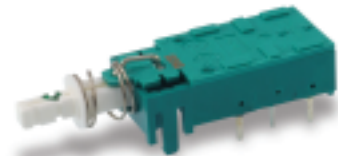
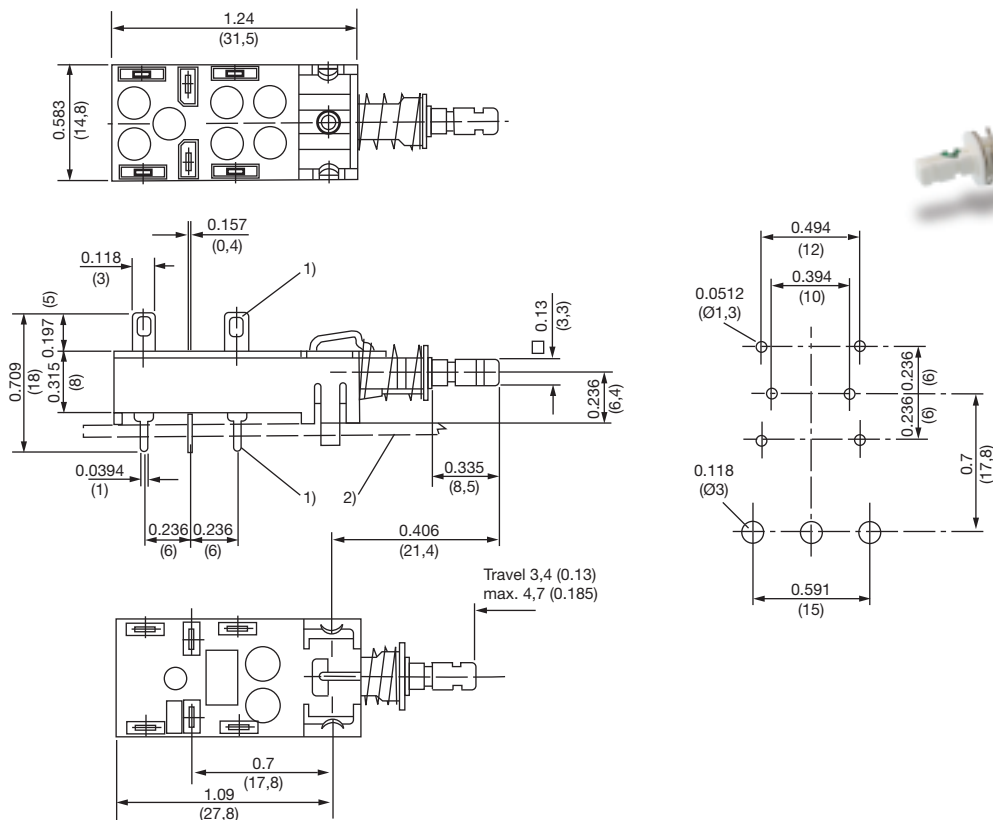

Dimensions are shown: Inches (mm)
Specifications and dimensions subject to change



A

Pushbutton

DESIGNATION & SWITCHES WITH STANDARD OPTIONS



ZNE1838EECF0201

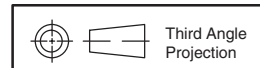
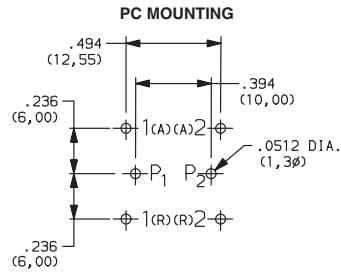
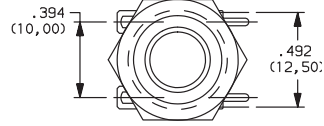
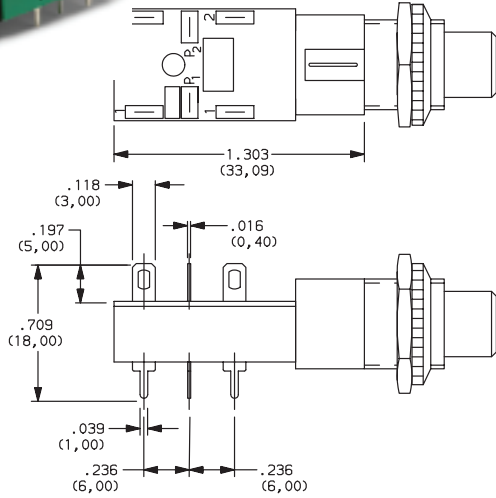
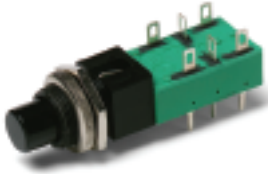

Dimensions are shown: Inches (mm)
Specifications and dimensions subject to change

C&K NE-18 Series Mains / Power Switches



Pushbutton

CONTACT ARRANGEMENT



OPTION CODE Contact capacity and availability	STYLE	ELECTRICAL CIRCUIT
37	NE18 – 2AX	DPST
38	NE18 – 2UX	DPDT
51	2U + NE18 – 2AX	DPST*
52 (4A/64)	NE18CTII – 2AX	DPST
39	2U + NE18 – 2UX	DPDT*
41	NE18 – 2AP	DPST
42	NE18 – 2UP	DPDT
43	NE18 – 2AW	DPST
44	NE18 – 2UW	DPDT
45	NE18 – 2ASX	DPST

OPTION CODE Contact capacity and availability	STYLE	ELECTRICAL CIRCUIT
46	NE18 – 2USX	DPDT
47	NE18 – 2ASP	DPST
48	NE18 – 2USP	DPDT
49	NE18 – 2ASW	DPST
50	NE18 – 2USW	DPDT
53 (4A/64)	2U + NE18CTII – 2AX	DPST
54	2U + NE18 – 2AW	DPST
55	2U + NE18 – 2AP	DPST
56	2U + NE18 – 2UW	DPDT
57	2U + NE18 – 2UP	DPDT

* 2U + Denotes auxiliary set of low current contacts DPDT
 2A = DPST
 2U = DPDT
 S = Snap-in mounting
 X = Solder lug/PC pins
 W = Solder lugs only
 P = PC pins only

NOTES
 1. Contact plating is silver on all Power Switches.
 2. The electrical function is Break Before Make (BBM) on all Power Switches.
 3. The terminals will be epoxy sealed.

TYPE	POSSIBLE CONTACT ARRANGEMENT		CONTACT SPACING	PROTECTION CLASS (CEE 24)	APPROVALS
	POWER CONTACTS ¹	AUXILIARY CONTACTS			
NE18	2A ²	2U	> 3mm (.118 inch)	II	VDE, BSI, DEMKO, NEMKO, SEMKO, SEV, CSA, UL
NE18	2A ² 2U	2U	> 3mm (m) (.118 inch)	I	VDE, MEEI, BSI ³ , DEMKO, NEMKO, SEMKO, SEV, CSA, UL
NE18CTII	2A ²	2U	> 3mm (.118 inch)	II	VDE, BSI, DEMKO, CSA, SEMKO, SEV, UL, NEMKO

1) A = make contact, R = break contact, U = changeover contact, m = VDE sign for switches with a contact spacing (air gap) < 3mm (.118 inch) according to VDE 0630/CEE 24.
 2) With 2A mains contacts: Mounting only by PC pins is not sufficient.
 3) BSI only for 2U mains contacts.

MECHANICAL FUNCTION



OPTION CODE	FUNCTION
OA	Momentary
EE	Alternate (push-push)

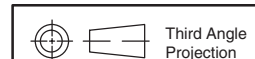

Dimensions are shown: Inches (mm)
 Specifications and dimensions subject to change



A

Pushbutton

C&K NE-18 Series Mains / Power Switches

SINGLE STATION CHASSIS



01 WITH .094 MOUNTING HOLES

(NONE) NO CHASSIS

02 WITH 4-40 TAPPED MOUNTING HOLES

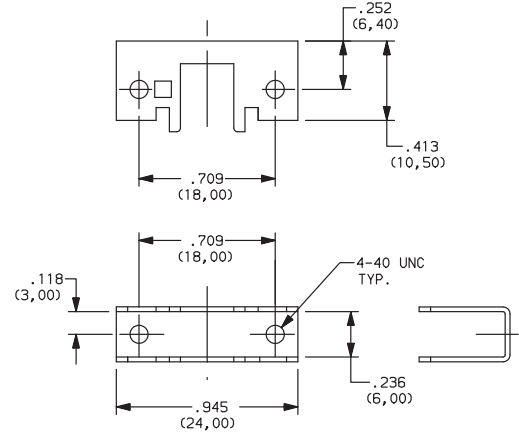
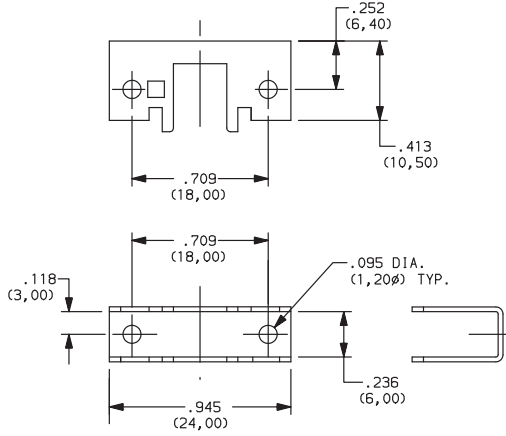

03 SPECIAL CHASSIS (CONSULT FACTORY)

DRESS NUT



(NONE) NO DRESS NUT

B BLACK

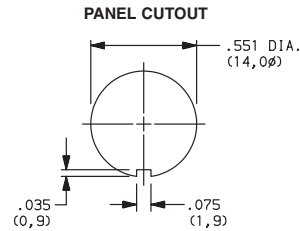
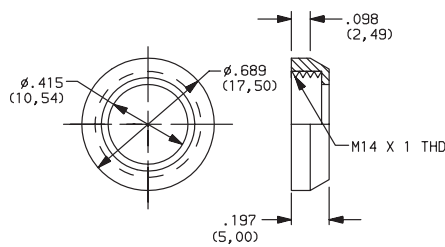

NOTE: Available with ZNE18 designation and FA200 buttons.

C CHROME

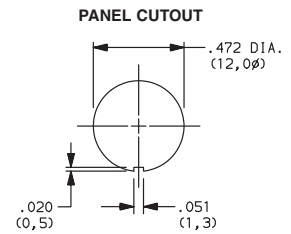
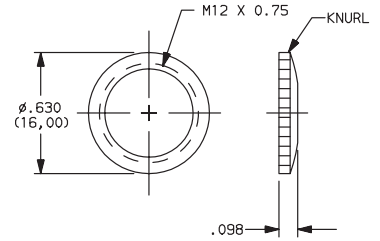

NOTE: Available with ZNE18 designation and FG button.

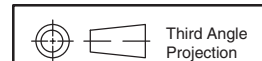

Dimensions are shown: Inches (mm)
Specifications and dimensions subject to change

C&K NE-18 Series Mains / Power Switches



A

Pushbutton

SOLID BUTTON

STYLE

F01 FMR

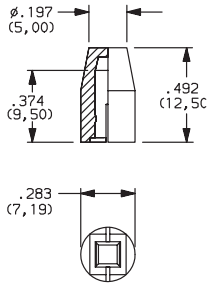

F02 FG

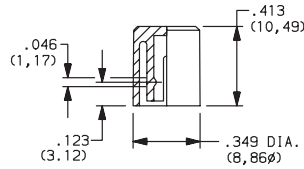

F12 FSC

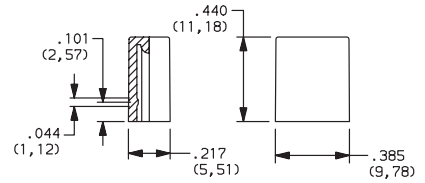
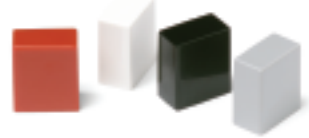

F13 FSD

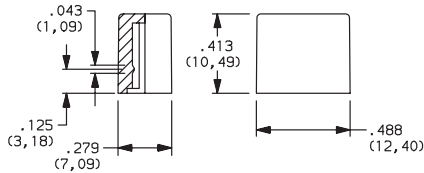
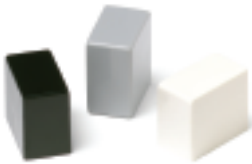

F14 FU12

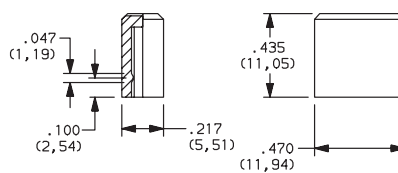
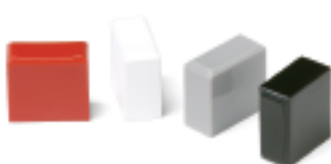

F15 FSB

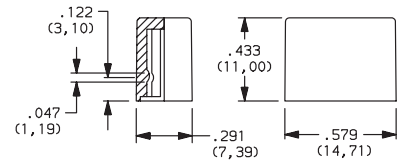
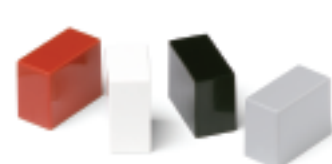

F16 FE

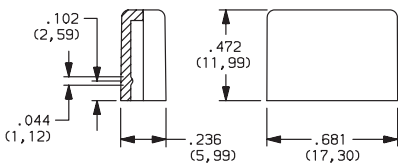
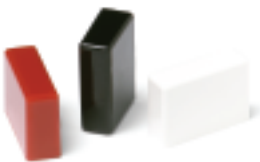

F19 FA

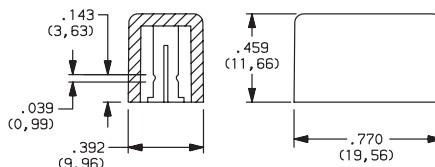

OPTION CODE	COLOR
01	BLACK
02	WHITE
03	RED
04	LT. GRAY



Third Angle Projection
 Dimensions are shown: Inches (mm)
 Specifications and dimensions subject to change

C&K NE-18 Series Mains / Power Switches



A

Pushbutton

SOLID BUTTON

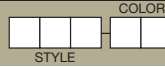

STYLE

F21 F001

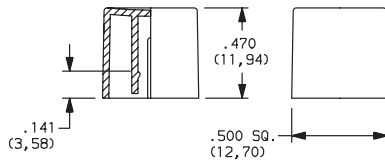

OPTION CODE	COLOR
01	BLACK
02	WHITE
03	RED
04	LT. GRAY
09	BLACK/CHROME (F03, F06 & F07 buttons only)

MECHANICAL BUTTON

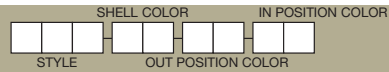

STYLE

F01 FA100

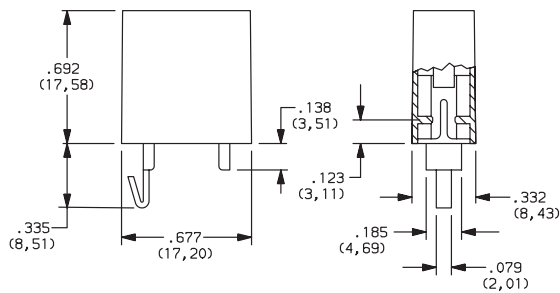

F02 FA101

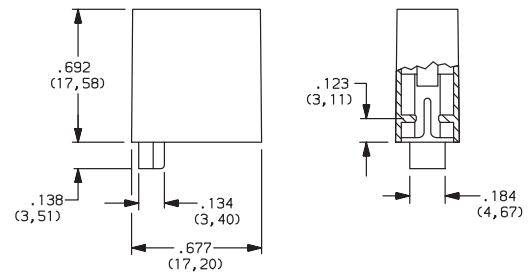

Dimensions are shown: Inches (mm)
Specifications and dimensions subject to change



C&K NE-18 Series Mains / Power Switches

MECHANICAL BUTTON

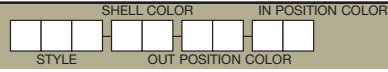

A

Pushbutton

STYLE

F08 FA201

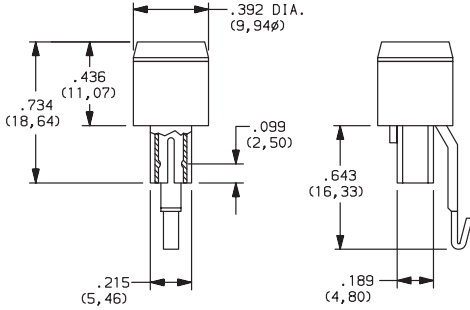

F11 FA200

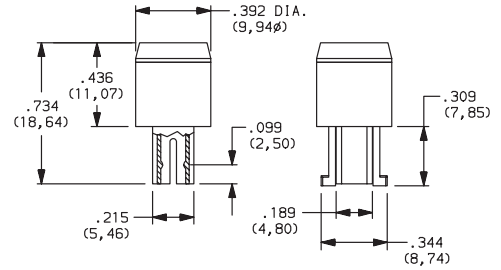

SHELL COLOR

01 BLACK

OUT POSITION COLOR

01 BLACK

IN POSITION COLOR

OPTION CODE	COLOR
02	WHITE
06	YELLOW
07	BLUE
08	GREEN
12	ORANGE

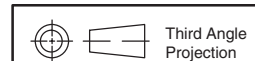

Dimensions are shown: Inches (mm)
Specifications and dimensions subject to change