

Features

Mechanical time switches

- Daily time setting *
- Weekly time setting **

- **Type 12.01** - 1 Pole 16 A CO (SPDT)
35.8 mm width
- **Type 12.11** - 1 Pole 16 A NO (SPST-NO)
17.6 mm width
- **Type 12.31-0000** daily -
1 Pole 16 A CO (SPDT)
- **Type 12.31-0007** weekly -
1 Pole 16 A CO (SPDT)
- Minimum time interval setting:
1h (12.31-0007)
30 min (12.01)
15 min (12.11 - 12.31-0000)

* Same program every day

** Different program possible for each of the 7 days of the week

For outline drawing see page 10

Contact specification

Contact configuration	1 CO (SPDT)	1 NO (SPST-NO)	1 CO (SPDT)
Rated current/Maximum peak current A	16/—	16/30	16/—
Rated voltage/Maximum switching voltage V AC	250/—	250/—	250/—
Rated load AC1 VA	4,000	4,000	4,000
Rated load AC15 (230 V AC) VA	750	420	420
Nominal lamp rating: incandescent (230 V) W	2,000 (NO contact)	2,000	2,000
compensated fluorescent (230 V) W	750 (NO contact)	750	750
uncompensated fluorescent (230 V) W	1,000 (NO contact)	1,000	1,000
halogen (230 V) W	2,000 (NO contact)	2,000	2,000
Minimum switching load mW (V/mA)	1,000 (10/10)	1,000 (10/10)	1,000 (10/10)
Standard contact material	AgCdO	AgCdO	AgCdO

Supply specification

Nominal voltage (U _N)	V AC (50/60 Hz)	230	230	120 - 230
	V DC	—	—	—
Rated power AC/DC	VA (50 Hz)/W	2/—	2/—	2/—
Operating range	AC (50 Hz)	(0.85...1.1)U _N	(0.85...1.1)U _N	(0.85...1.1)U _N
	DC	—	—	—

Technical data

Electrical life at rated load in AC1	cycles	50 · 10 ³	50 · 10 ³	50 · 10 ³
Type of time switch		daily	daily	daily weekly
Switching intervals /day		48	96	96 24 (168/week)
Minimum switching interval	min	30	15	15 60
Accuracy	s/day	1.5	1.5	1.5
Ambient temperature range	°C	-5...+50	-5...+50	-10...+50
Protection category		IP 20	IP 20	IP 20

Approvals (according to type)



12.01



- Mechanical daily time switch
- 1 CO (SPDT)
- 35 mm rail (EN 60715) mount



12.11



- Mechanical daily time switch
- 1 NO (SPST-NO)
- 35 mm rail (EN 60715) mount

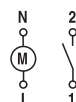

12.31



- Mechanical daily or weekly
- 1 CO (SPDT)
- Front panel mounting

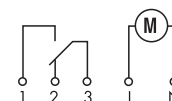

Features

12.51 - Digital (analogue-style) time switch, daily/weekly programming

- 30 minutes interval setting
- Easily configurable for daily or weekly programming

12.81 - Digital astro-switch

- Astro program: calculation of sunrise and sunset times through date, time and location coordinates
- Option for Astro ON period override, by timeswitch
- Location coordinates easily settable for most European countries through post codes
- Offset function: allows programming of switching times offset from the astronomic time (by up to 90 min, in 10 min steps)

- Summer/winter European time
- 1 CO 16 A output contact
- LCD status indication, set-up and programming
- Back-light display
- Internal battery for set-up and programming without supply, easily replaceable from the front
- Protective separation between supply and contacts
- 35 mm rail (EN 60715) mount
- Cadmium free contact material

NEW 12.51



- Digital time switch
- 1 CO (SPDT)
- 35 mm rail (EN 60715) mount

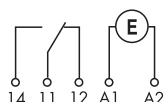

NEW 12.81



- Astro-time switch
- 1 CO (SPDT)
- 35 mm rail (EN 60715) mount

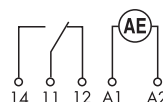

For outline drawing see page 10

Contact specification			
Contact configuration		1 CO (SPDT)	1 CO (SPDT)
Rated current/Maximum peak current	A	16 / 30 (120 A – 5 ms)	16 / 30 (120 A – 5 ms)
Rated voltage/Maximum switching voltage V AC		250/400	250/400
Rated load AC1	VA	4,000	4,000
Rated load AC1.5 (230 V AC)	VA	750	750
Nominal lamp rating: incandescent (230 V) W		2,000	2,000
compensated fluorescent (230 V) W		750	750
energy saving (CFL, LED) (230 V) W		200	200
halogen (230 V) W		2,000	2,000
Minimum switching load	mW (V/mA)	1,000 (10/10)	1,000 (10/10)
Standard contact material		AgSnO ₂	AgSnO ₂
Supply specification			
Nominal voltage (U _N)	V AC (50/60 Hz)	120 - 230	230
	V DC	—	—
Rated power	VA (50 Hz)/W	6.6/2.9	6.6/2.9
Operating range	AC (50 Hz)	(0.8...1.1)U _N	(0.8...1.1)U _N
	DC	—	—
Technical data			
Electrical life at rated load in AC1	cycles	100 · 10 ³	100 · 10 ³
Switching intervals		48	—
Minimum switching interval		30	—
Accuracy	s/day	1	1
Ambient temperature range		–20...+50	–20...+50
Protection category		IP 20	IP 20
Approvals (according to type)		CE	EAC

Features

Electronic digital time switches

- Weekly time setting

- **Type 12.21** - 1 Pole 16 A CO (SPDT)
35.8 mm width
- **Type 12.22** - 2 Pole 16 A CO (DPDT)
35.8 mm width
- **Type 12.71** - 1 Pole 16 A CO (SPDT)
17.6 mm width
- Available for 230 V AC or 12, 24 V AC/DC supply
- Minimum time interval setting - 1 minute
- Internal battery for set-up without supply
- Impulse output function:
- 1s... 59: 59(mm:ss)
- Automatic adjustment for daylight saving
- 35 mm rail (EN 60715) mount

12.21



- Digital weekly time switch
- 1 CO (SPDT)
- 35 mm rail (EN 60715) mount

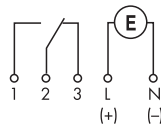

12.22



- Digital weekly time switch
- 2 CO (DPDT)
- 35 mm rail (EN 60715) mount

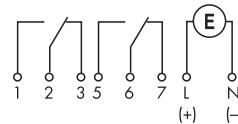

12.71



- Digital weekly time switch
- 1 CO (SPDT)
- 35 mm rail (EN 60715) mount

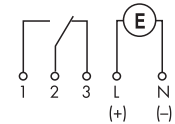

For outline drawing see page 10, 11

Contact specification		12.21		12.22		12.71	
Contact configuration		1 CO (SPDT)		2 CO (DPDT)		1 CO (SPDT)	
Rated current/Maximum peak current	A	16/30		16/30		16/30	
Rated voltage/Maximum switching voltage V AC		250/—		250/—		250/—	
Rated load AC1	VA	4,000		4,000		4,000	
Rated load AC15 (230 V AC)	VA	750		750		420	
Nominal lamp rating: incandescent (230 V) W		2,000 (NO contact)		2,000 (NO contact)		2,000 (NO contact)	
compensated fluorescent (230 V) W		420 (NO contact)		420 (NO contact)		420 (NO contact)	
uncompensated fluorescent (230 V) W		1,000 (NO contact)		1,000 (NO contact)		1,000 (NO contact)	
halogen (230 V) W		2,000 (NO contact)		2,000 (NO contact)		2,000 (NO contact)	
Minimum switching load	mW (V/mA)	1,000 (10/10)		1,000 (10/10)		1,000 (10/10)	
Standard contact material		AgCdO		AgCdO		AgNi	
Supply specification		12.21		12.22		12.71	
Nominal voltage (U _N)	V AC (50/60 Hz)	—	120 - 230	—	120 - 230	—	230
	V AC/DC	12 - 24	—	24	—	24	—
Rated power AC/DC	VA (50 Hz)/W	1.4/1.4	2/—	1.4/1.4	2/—	1.4/1.4	2/—
Operating range	AC (50 Hz)	(0.9...1.1)U _N	(0.85...1.1)U _N	(0.9...1.1)U _N	(0.85...1.1)U _N	(0.9...1.1)U _N	(0.85...1.1)U _N
	DC	(0.9...1.1)U _N	—	(0.9...1.1)U _N	—	(0.9...1.1)U _N	—
Technical data		12.21		12.22		12.71	
Electrical life at rated load in AC1	cycles	50 · 10 ³		50 · 10 ³		50 · 10 ³	
Type of time switch		weekly		weekly		weekly	
Memory locations for switching times *		30		30		30	
Minimum interval setting	min	1		1		1	
Accuracy	s/day	0.5		0.5		0.5	
Ambient temperature range	°C	-30...+55		-30...+55		-30...+55	
Protection category		IP 20		IP 20		IP 20	
Approvals (according to type)							

* Switching times in memory may be used more than once i.e. when selected for different days.

Features

Electronic digital time switches

- weekly time setting

- **Type 12.91...0000 "ZENITH"**
1 pole 16 A CO (SPDT)
35.8 mm width
- **Type 12.91...0090 "ZENITH"**
1 pole 16 A CO (SPDT)
35.8 mm width
version for programming via PC by a special Key Memory (included)
- **Type 12.92...0090 "ZENITH"**
2 pole 16 A CO (DPDT)
35.8 mm width
version for programming via PC by a special Key Memory (included)
- **Type 12.92 "ZENITH"**
2 Pole 16 A CO (DPDT)
35.8 mm width
- Astro program:
calculation of sunrise and sunset times through date, time and location coordinates (longitude and latitude)
- Offset function: allows programming of switching times offset (+ or -) from the astronomic time
- Minimum time interval setting - 1 minute
- Internal battery for set-up without supply
- Automatic adjustment for daylight saving
- 35 mm rail (EN 60715) mount

12.91...0000



12.91...0090/12.92...0090



12.92



- Digital weekly time switch
- 1 CO (SPDT)
- 35 mm rail (EN 60715) mount

- Digital weekly time switch
- Type 12.91: 1 CO (SPDT)
- Type 12.92: 2 CO (DPDT)
- Version for programming via PC by a special key memory
- 35 mm rail (EN 60715) mount

- Digital weekly time switch
- 2 CO (DPDT)
- 35 mm rail (EN 60715) mount

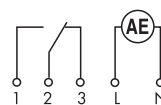
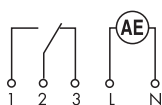

12.91...0090

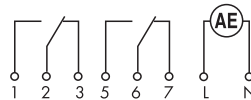
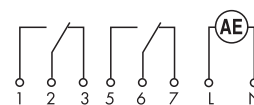

12.92...0090

For outline drawing see page 11

Contact specification				
Contact configuration		1 CO (SPDT)	1 CO (SPDT) / 2 CO (DPDT)	2 CO (DPDT)
Rated current/Maximum peak current	A	16/30	16/30	16/30
Rated voltage/Maximum switching voltage	V AC	250/—	250/—	250/—
Rated load AC1	VA	4,000	4,000	4,000
Rated load AC15 (230 V AC)	VA	750	750	750
Nominal lamp rating: incandescent (230 V)	W	2,000 (NO contact)	2,000 (NO contact)	2,000 (NO contact)
compensated fluorescent (230 V)	W	420 (NO contact)	420 (NO contact)	420 (NO contact)
uncompensated fluorescent (230 V)	W	1,000 (NO contact)	1,000 (NO contact)	1,000 (NO contact)
halogen (230 V)	W	2,000 (NO contact)	2,000 (NO contact)	2,000 (NO contact)
Minimum switching load	mW (V/mA)	1,000 (10/10)	1,000 (10/10)	1,000 (10/10)
Standard contact material		AgSnO ₂	AgSnO ₂	AgSnO ₂
Supply specification				
Nominal voltage (U _N)	V AC (50/60 Hz)	230	230	230
Rated power AC/DC	VA (50 Hz)/W	2/—	2/—	2/—
Operating range	AC (50 Hz)	(0.85...1.1)U _N	(0.85...1.1)U _N	(0.85...1.1)U _N
Technical data				
Electrical life at rated load in AC1	cycles	50 · 10 ³	50 · 10 ³	50 · 10 ³
Type of time switch		weekly	weekly	weekly
Memory locations for switching times *		60	60	60
Minimum interval setting	min	1	1	1
Accuracy	s/day	0.5	0.5	0.5
Ambient temperature range	°C	-30...+55	-30...+55	-30...+55
Protection category		IP 20	IP 20	IP 20
Approvals (according to type)				

Ordering information

Example: 12 series digital/analogue time switch, 1 CO 16 A contact, 230 V AC supply



Series

Type

- 0 = Daily, 35.8 mm wide
- 1 = Daily, 17.5 mm wide
- 3 = Daily or Weekly, 72x72 mm
- 5 = Digital/analogue time switch, 35 mm wide
- 2 = Weekly, 35.8 mm wide
- 7 = Weekly, 17.5 mm wide
- 8 = Astro-switch, 35 mm wide
- 9 = Weekly "Astro", 35.8 mm wide

No. of poles

- 1 = 1 CO (SPDT), 16 A
- 2 = 2 CO (DPDT), 16 A (type 12.22 and 12.92)

Option

- 0 = With power back-up
- 1 = Without power back-up (type 12.11)

Supply voltage

- 012 = 12 V AC/DC
- 024 = 24 V AC/DC
- 120 = 120 V AC
- 230 = 230 V AC

Supply version

- 0 = AC (50/60 Hz)/DC (types 12.21.0.012, 12.21.0.024, 12.22.0.024, 12.71.0.024)
- 8 = AC (50/60 Hz)

Option

- 0 = Standard
- 0 = Daily only for 12.31
- 7 = Weekly only for 12.31

Special version

- 0 = Standard
- 9 = Programming via PC
type 12.91.8.230.0090
type 12.92.8.230.0090

Technical data

Insulation		12.51, 12.81	12.01, 12.11, 12.31	12.21, 12.22, 12.71, 12.91, 12.92	
Dielectric strength between supply and contacts	VAC	4,000	4,000	4,000	
Dielectric strength between open contacts	VAC	1,000	1,000	1,000	
Rated impulse voltage (between supply and contacts)	kV/(1.2/50) μ s	6	6	6	
Rated impulse voltage (between open contacts)	kV/(1.2/50) μ s	1.5	1.5	1.5	
EMC specifications					
Type of test	Reference standard				
Electrostatic discharge	contact discharge	EN 61000-4-2	4 kV	6 kV	
	air discharge	EN 61000-4-2	8 kV	8 kV	
Radiated electromagnetic field (80...1,000 MHz)	EN 61000-4-3	10 V/m	10 V/m		
Fast transients (burst 5/50 ns, 5 and 100 kHz)	EN 61000-4-4	4 kV	4 kV		
Voltage pulses on supply terminals (surge 1.2/50 μ s)	common mode	EN 61000-4-5	4 kV	2 kV	
	differential mode	EN 61000-4-5	4 kV	2 kV	
Radiofrequency common mode voltage (0.15...80 MHz)	EN 61000-4-6	10 V	10 V		
Voltage dips	70 % U_N , 40 % U_N	EN 61000-4-11	10 cycles	10 cycles	
Short interruptions	EN 61000-4-11	10 cycles	10 cycles		
Radio frequency conducted emissions	0.15...30 MHz	EN 55014	class B	class B	
Radiated emissions	30...1,000 MHz	EN 55014	class B	class B	
Terminals					
 Screw torque	Nm	0.8	1.2		
		12.51, 12.81	12.01, 12.11, 12.31		
Max. wire size		mm ²	AWG	mm ²	AWG
	solid cable	1 x 6 / 2 x 4	1 x 10 / 2 x 12	1 x 6 / 2 x 4	1 x 10 / 2 x 12
	stranded cable	1 x 4 / 2 x 2.5	1 x 12 / 2 x 14	1 x 6 / 2 x 2.5	1 x 10 / 2 x 14
Max. wire size		12.21, 12.22, 12.71, 12.91, 12.92			
		mm ²	AWG		
	solid cable	1 x 6 / 2 x 4	1 x 10 / 2 x 12		
stranded cable	1 x 6 / 2 x 2.5	1 x 10 / 2 x 14			
Wire strip length	mm	9			
Other data					
Power back-up (Battery life)		6 years (12.51, 12.81, 12.21, 12.22, 12.71, 12.91, 12.92)			
Battery type		CR 2032, 3V, 230 mAh			
Power back-up		100 h (12.01, 12.11, 12.31 - following 80 h continuous energisation)			
Power lost to the environment		12.51, 12.81	12.01, 12.11, 12.31	12.21, 12.22, 12.71, 12.91, 12.92	
	in stand-by W	1.4	—	—	
	without contact current W	2.9	1.5	2	
with rated current W		3.5	2.5	3 (for 1 pole)/4 (for 2 pole)	

Wiring diagrams

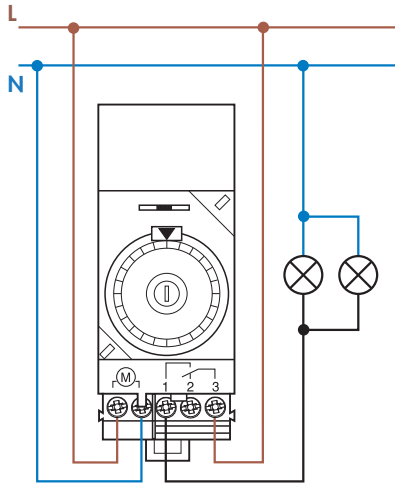

Type 12.01
Selector switch:
⊖ = Permanently OFF
AUTO = Automatic
I = Permanently ON

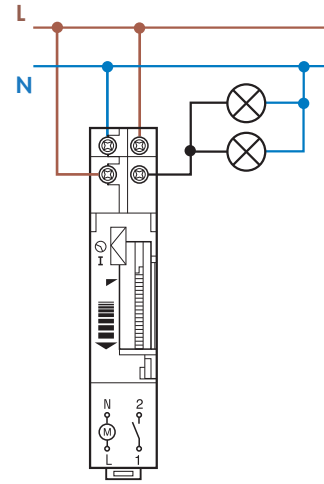

Type 12.11
Selector switch:
⊖ = Automatic
I = Permanently ON

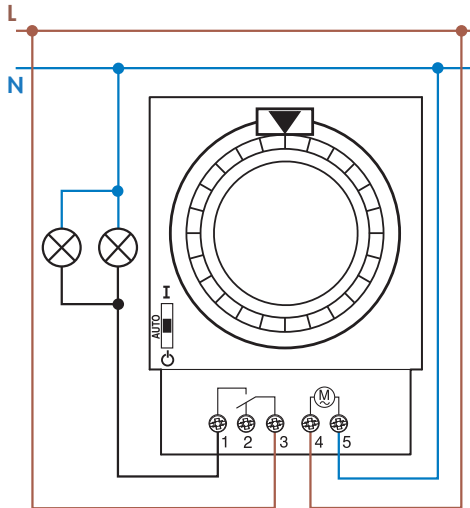

Type 12.31

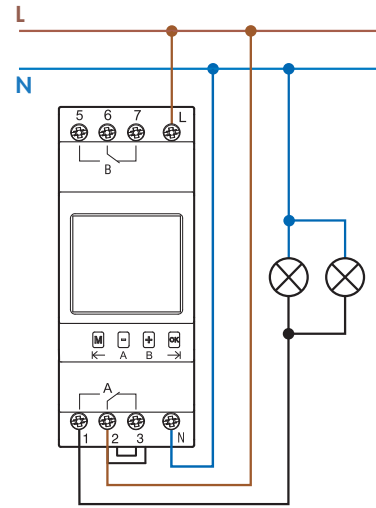

Type 12.21
12.22
12.91
12.92

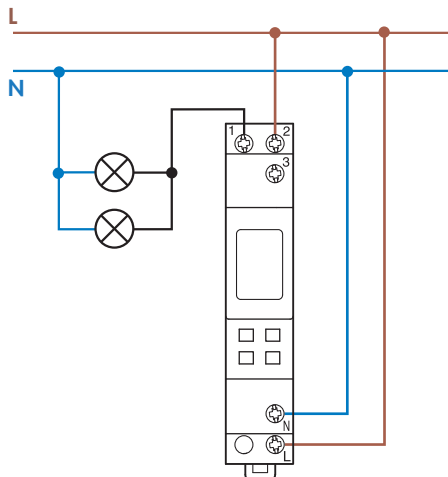

Type 12.71

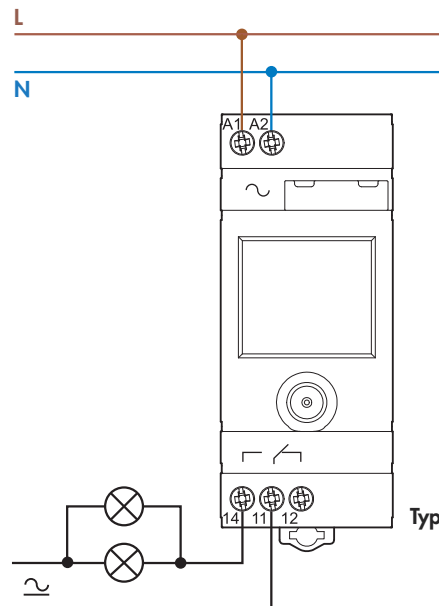

Type 12.51
12.81

Accessories for type 12.71 and 12.91



012.90

PC programming kit for type 12.71, 12.91.8.230.0090, 12.92.8.230.0090 | 012.90

This special PC programming kit, permits fast and easy programming of the Time Switch with a PC or Laptop. The program transfer can be done by the special Key Memory (supplied with the 12.91.8.230.0090, 12.92.8.230.0090) or directly by the Time switch 12.71.
Contents: Programming adaptor, USB cable (1.8 meter length), Software.

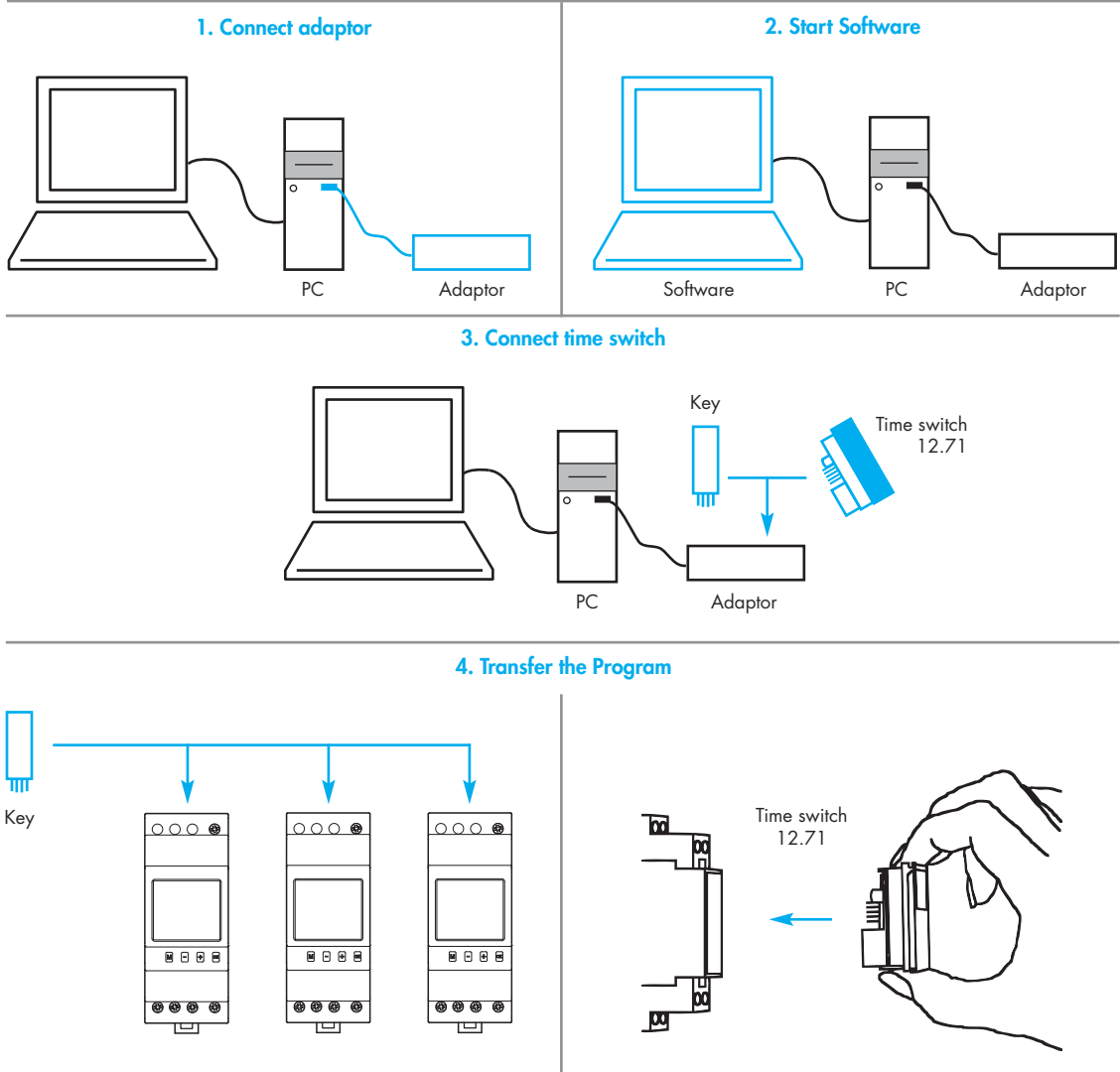

PC Programming software

Easy and intuitive software to create programs for the Time Switch, in a few fast steps. For Windows 7, 8, 2000/XP/Vista.

Residential applications

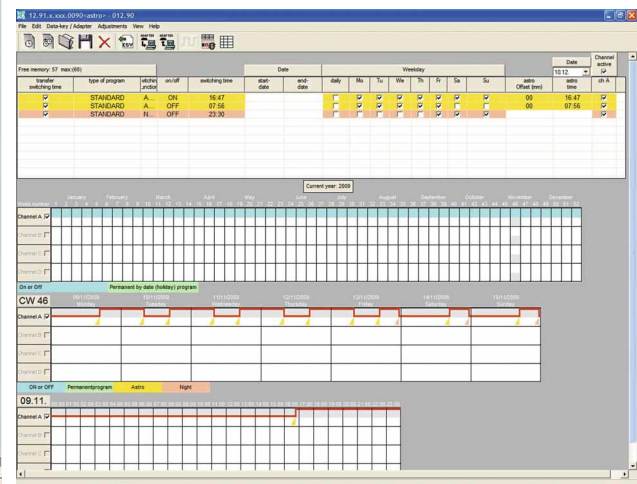
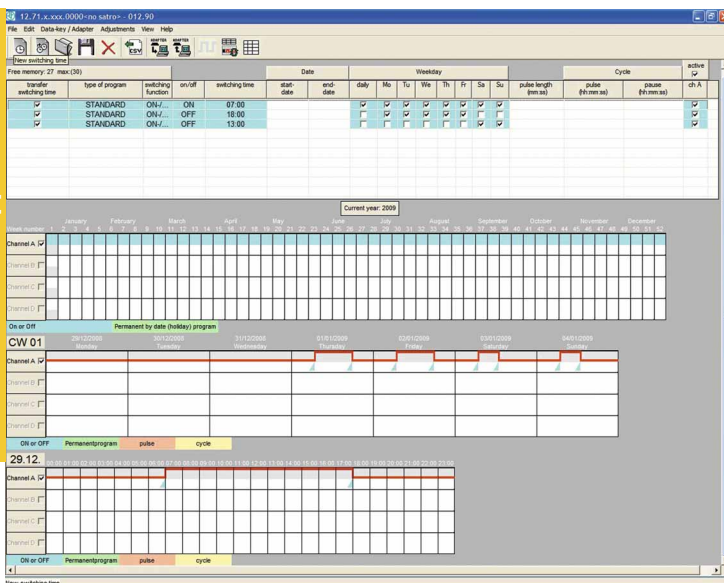

Battery replacement type 12.51 and 12.81



Accessories type 12.51 and 12.81



011.01

Adaptor for panel mounting, 35 mm wide

011.01

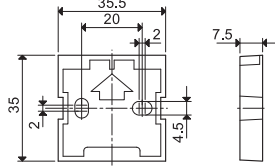

Outline drawings

12.01
Screw terminal

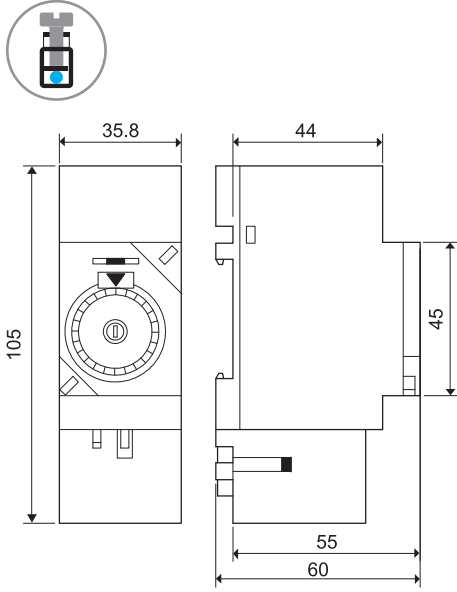

12.11
Screw terminal

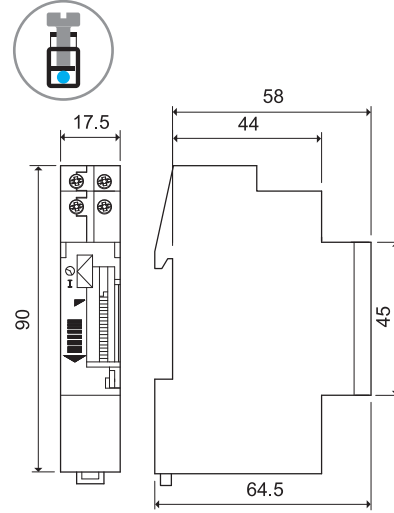

12.21
Screw terminal

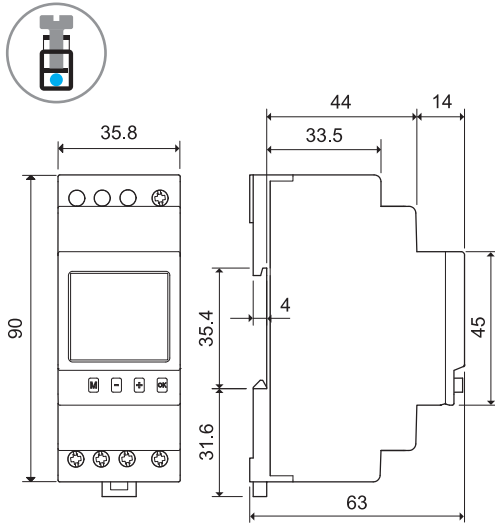

12.22
Screw terminal

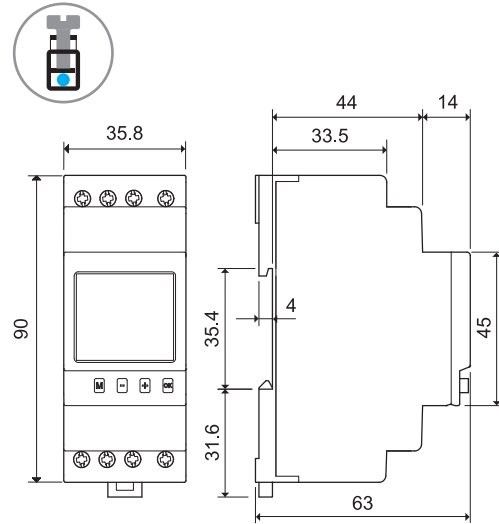

12.31
Screw terminal

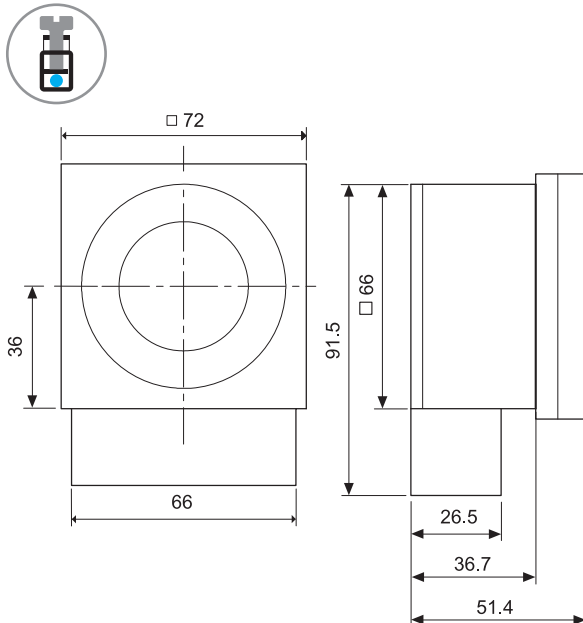

12.51/12.81
Screw terminal

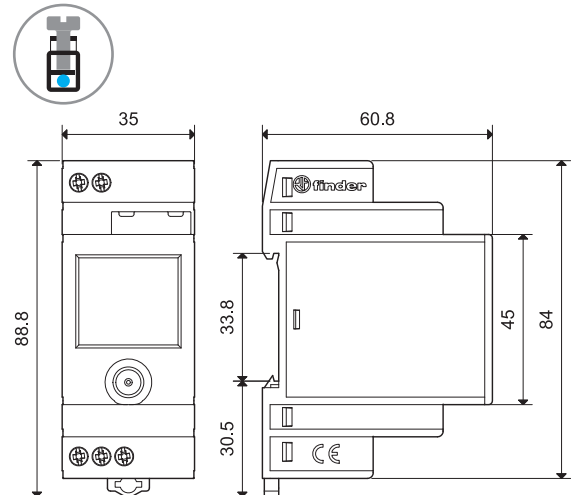

Outline drawings

12.71
Screw terminal

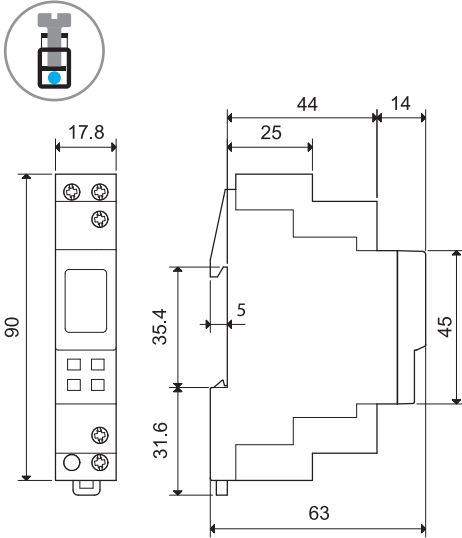

12.91...0000
Screw terminal

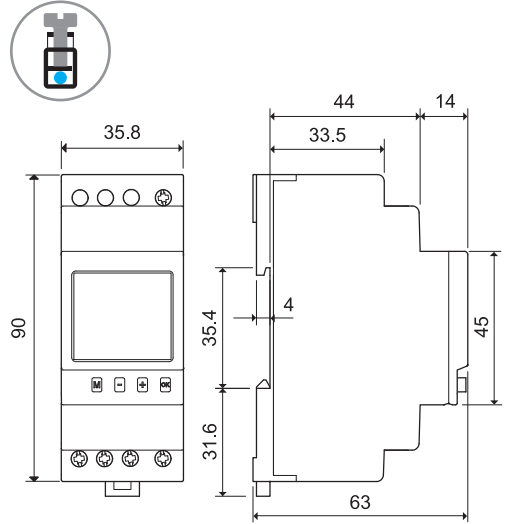

12.91...0090 / 12.92...0090
Screw terminal

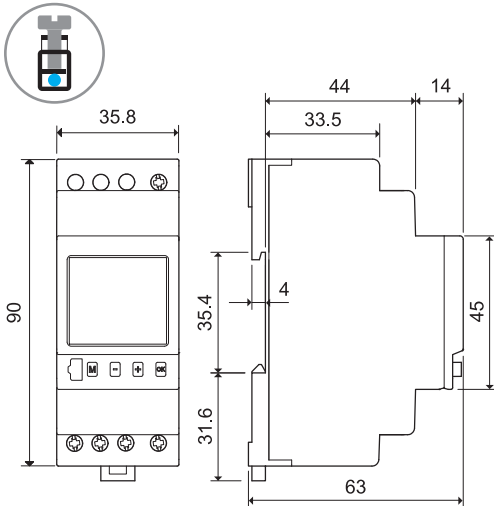

12.92
Screw terminal

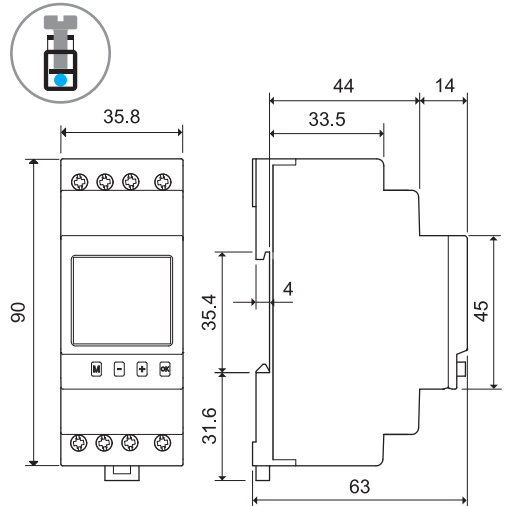

Functions type 12.51

All the functions and the values can be set through the joystick and are displayed on the LCD.

Display mode

During normal operation, with AC supply connected, the following is displayed:

- the current time (hours and minutes)
- the status (ON/OFF and symbol of contact open/closed) of the 11-14 output contact
- the program for the current day (each solid segment represents an half-hour interval set to ON)

From **Display mode** it is possible to enter in **Program mode** or **Setup mode** respectively with a short or long (> 2s) press to the joystick centre (⊙).



Manual mode

From **Display mode** it is also possible to enter in **Manual mode**, where (independently from the program) the 11-14 output contact can be forced into the ON or OFF position with a long (> 2s) press to the joystick (⬆) or (⬇) directions, respectively. The "hand" symbol is then displayed.

A long press in the opposite direction will exit the manual mode.

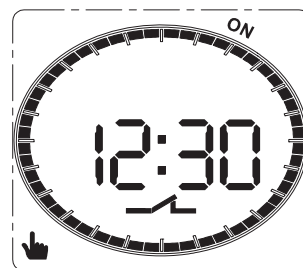

Setup mode

In this mode it is possible to set (in the following order):

- daily/weekly function
- current year
- current day
- current month
- current hour
- current minute
- enable/disable european summer time.

With a short press of the joystick (⬆) or (⬇), it is possible to pass from one setup step to another (confirming the set values); in any step it is possible to modify the set values with a short press to the joystick (⬆) or (⬇). A sustained (> 1s) press results in the fast increasing (or decreasing) of values.

A short press to the joystick centre (⊙) will restore the Display mode.

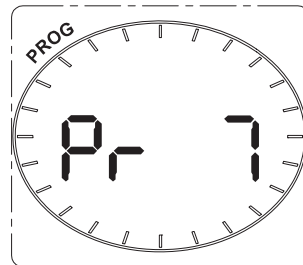

Note: the product is supplied factory set to Central Europe time with european summer time enabled.







Functions type 12.51

Program mode (daily)

In this mode it is possible to set the "pattern" of time segments, which define the ON time of the 11-14 output contact. This "pattern" will be the same for all days of the week (daily).

Entering Programming mode (from Display mode) with a short press to  takes the digital time to 00:00 (and any previously programmed segment pattern is displayed). Stepping backwards  or forwards  in time displays the appropriate segment time and the appropriate open or closed contact status for that time segment.



At any step it is possible to change the segment status with a short press to the joystick  (for ON) or  (for OFF) as appropriate, and this also automatically advances the time to the next segment, and always in a clockwise direction. If the joystick is pressed several times in, say, the  direction then each successive segment will assume the ON status. If it is then pressed several times in the  direction then each successive segment will assume the OFF status. This allows the rapid setting of many consecutive segments with the same status.

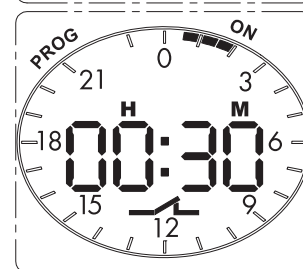
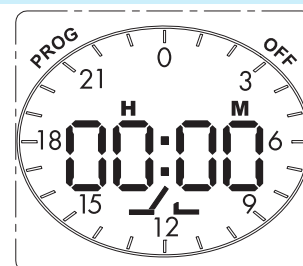



A short press to the joystick centre  will restore the display to the Display mode.



Program mode (weekly)

In this mode it is possible to set a different "pattern" of time segments for each day of the week (weekly).



Entering Programming mode (from Display mode) with a short press to  takes the display to the programming mode, for the current day. With a subsequent short press to  or  it is possible to pass from one day to another (Monday is day 1).

With the desired day selected it is possible to enter the programming mode for that day by pressing . Program the segments for that day by following the same procedure as described above for daily mode. When all 48 segments have been set, accept with a short press to . Then progress to the next day by pressing the joystick in the  or  direction. Repeat programming for the next day, and then repeat for other remaining days.

At any time return to the Display mode with a short press to the joystick centre .

COPY FUNCTION

View the particular day to be copied (using  or  as described above) and copy with a short press to  (the "copy icon" will then appear).

Then select another day, using  or , and paste the copied program with a short press to . This can be repeated for other days.

A short press to the joystick centre , or , will exit the copy function.

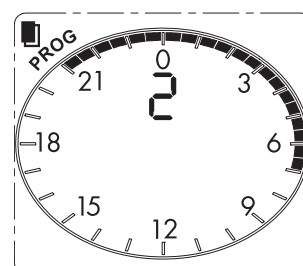
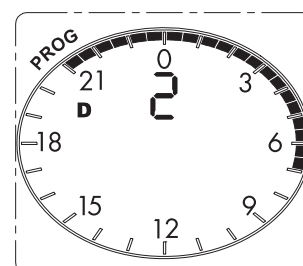

Power-save mode

If the 230 V AC supply is not connected, the time switch enters power-save mode: only the clock is maintained active whilst the display turns off so as to guarantee a long life for the built-in back-up battery.

With a press to the joystick it is possible to "awake" the device and enter Display mode (with the "plug" symbol displayed). A further press to  will enter the program or set-up mode as explained in the Display mode section above.

After about 1 minute of inactivity the power-save mode will start again. During program or set-up the current absorption is higher than in power-save mode, thus influencing the battery life.

In this mode the display back-light is not active. It is activated following a press to the joystick only with the 230 V AC supply connected, but after about 1 minute of inactivity the display back-light will turn off, and to activate it again it is necessary to press the joystick again.



Functions type 12.81

All the functions and the values can be set through the joystick and are displayed on the LCD.

Display mode

During normal operation, with AC supply connected, the following is displayed:

- the current time (hours and minutes)
- the status (ON/OFF and symbol of contact open/closed) of the 11-14 output contact

From **Display mode** it is possible to enter in **Program mode** or **Setup mode** respectively with a short or long (> 2s) press to the joystick centre (⊙).

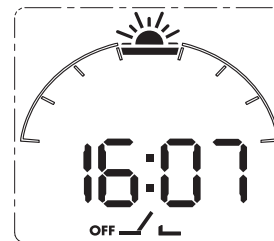

Manual mode

From **Display mode** it is also possible to enter in **Manual mode**, where (independently from the program) the 11-14 output contact can be forced into the ON or OFF position with a long (> 2s) press to the joystick (⊕) or (⊖) directions, respectively. The "hand" symbol is then displayed.

A long press in the opposite direction will exit the manual mode.



Setup mode

In this mode it is possible to set (in the following order):

- country (using Internet websites extension, e.g. IT, DE, FR..)
- post-code (CP, setting only the first 2 digits, 00 to 99 - or letters for UK)
- current year
- current day
- current month
- current hour
- current minute
- enable/disable european summer time.

From the Display mode - Enter the Setup mode with a long press (> 2 s) to (⊙).

With a short press to (→) or (←), it is then possible to pass from one setup step to another (confirming the set values). In any step it is possible to modify the set values with a short press to (⊕) or (⊖). A sustained (> 1s) press results in the fast increment (or decrement) of values.

A short press to the joystick centre (⊙) will restore the Display mode.

If the "country" is set to "Coor" (between IT and HU) or if the "postal code" is set to "Coor" (between 99 and 00*), press (→) to view the coordinates of latitude and use (⊕) or (⊖) to set between 30 and 64 ° North.

Press (→) again to view the coordinates of longitude and use (⊕) or (⊖) to set between 15 ° West and 50 ° East). Proceed in a similar way to set the time zone "Gmt" (00 corresponds to Greenwich Mean Time, 01 Central Europe, 02 Eastern Europe, and 03 European Russia), and then continue with setting year, day, month etc..

*or between ZE and AB for UK post codes.

Note: the product is supplied with the following factory settings:

- Central Europe time,
- european summer time enabled,
- country Italy,
- post-code 00 (the capital city Rome).

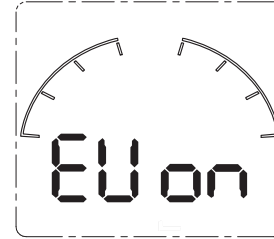
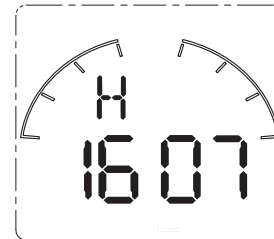
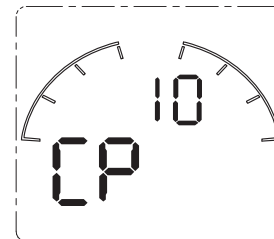
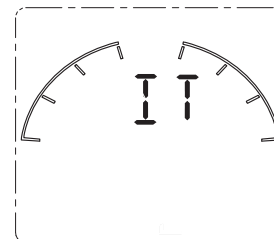
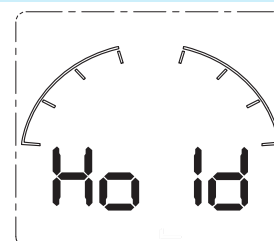

Functions type 12.81

Program mode (advance/retard setting)

In this mode it is possible to set independently:

- the advance (or the retard) of the light turn-on time in the evening with respect to the "astronomic" sunset time.
- the advance (or the retard) of the light turn-off time in the morning with respect to the "astronomic" sunrise time;

From the Display mode - A short press of the joystick (⊙) will display the "astronomic" sunset time, indicated by the (clockwise) transition from ☀️ to 🌙 ("ON" and closed contact symbols displayed). A short press to ⬆️ or ⬇️ will retard or advance the switch ON time about the astronomic time in 10 minute steps (up to a maximum of 90 min.).

Press ⬆️ to display the "astronomic" sunrise time, indicated by the (clockwise) transition from 🌙 to ☀️ ("OFF" and open contact symbols displayed). Again, a short press to ⬆️ or ⬇️ will retard or advance the switch OFF time about the "astronomic" time, in 10 minute steps.

At this point, either exit (to Display mode) with a short press to ⊙, or continue to set the **Astro ON period override time(s)** with a short press to ⬆️.

Set the OFF time using ⬆️ or ⬇️. A further short press to ⬆️ will display the ON time which again can be set using ⬆️ or ⬇️.

Note: setting "--:" for either OFF or ON means the function is inoperative.

Continuing to press ⬆️ will cycle through the "sunset" / "sunrise" / "OFF" / "ON" settings in turn.

A short press to ⊙ at any time will return the display to Display mode.

Note 1: The effect of the retard/advance settings is valid for all days. That is; lights will, for example, always turn-on every day for 30 minutes before the "astronomic" sunset time.

Note 2: The effect of the On period override settings is also valid for all days - but also see Note 3 by the function diagrams.

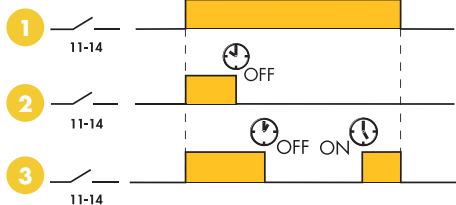

*Note 3: Depending on the time of year (summer specifically) it may be that the override ON time will fall after the AstroOFF time. In this case, the output switches off at the Astro OFF time and the override ON time is ignored.

The Override feature permits the 12.81 three different ways of functioning:

- 1 Classic function where the **AstroON** and **AstroOFF** times are determined by the geographic coordinates. These times vary every day.
- 2 Functions such that the output turns on according to the **AstroON** time and turns off according to the clock off-time ⌚_{OFF}. Application example: shop window lighting on by **AstroON** at sunset and off ⌚_{OFF} at 00:30.
- 3 Functions such that the output turns on according to the **AstroON** time and turns off according to the clock off-time ⌚_{OFF}, and then turns back on at the clock on-time ⌚_{ON} (for the remainder of the ASTRO time period). Application example: company car park lighting, on by **AstroON** at sunset, off end of the evening shift at 23:00 ⌚_{OFF}. On again at the beginning of the morning shift at 5:00 ⌚_{ON} and off automatically by AstroOFF*.

Power-save mode

If the 230 V AC supply is not connected, the time switch enters power-save mode: only the clock is maintained active whilst the display turns off so as to guarantee a long life for the built-in back-up battery. With a press to the joystick it is possible to "awake" the device and enter Display mode (with the "plug" symbol displayed). A further press to ⊙ will enter the program or set-up mode as explained in the Display mode section above.

After about 1 minute of inactivity the power-save mode will start again. During program or set-up the current absorption is higher than in power-save mode, thus influencing the battery life.

In this mode the display back-light is not active. It is activated following a press to the joystick only with the 230 V AC supply connected, but after about 1 minute of inactivity the display back-light will turn off, and to activate it again it is necessary to press the joystick again.

Note: the output relay only functions if the power supply is connected.

