

## Connectors according to DIN 41612 / IEC 60603-2

### Type R

Female connector

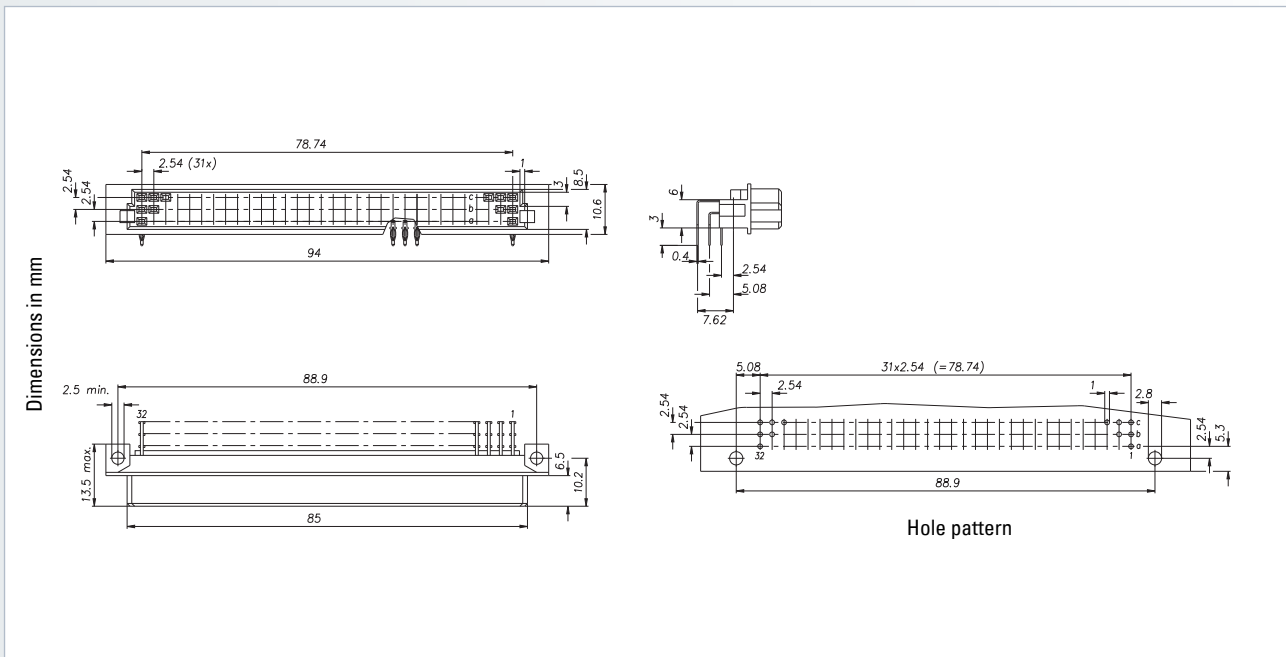

No. of contacts	Contact arrangement	Press-fit technology – Performance level II
		Termination length
		Part number
64		116-60054
96		116-60074

#### Accessories

- Press-fit tool (see page 210)
- Support tool (see page 211)

#### On request

- Performance levels I + III or customer-specific
- Special contact length

#### Options

- Without flange
- Contact arrangement (see page 162)

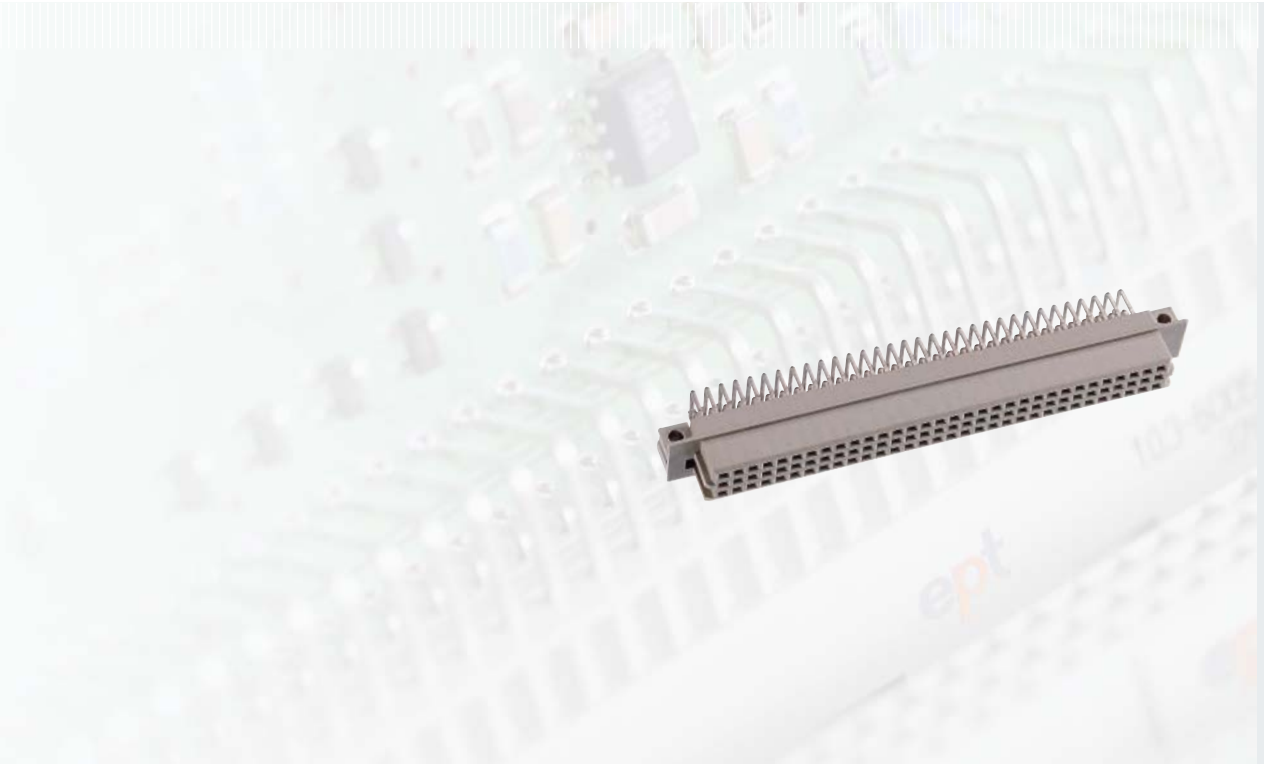

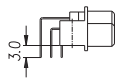
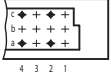
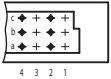
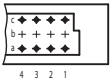
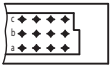
No. of contacts	Contact arrangement	Solder technology – Performance level II	
		Termination length	
			
		Part number	
32		116-40034	
48		116-40044	
64		116-40054	
96		116-40074	

**On request**

- Performance levels I + III or customer-specific
- Special contact length
- Also in THTR

**Options**

- Board lock (see page 159)
- Contact arrangement (see page 162)