

## Features

Level control relays for conductive liquids

**72.01 - Adjustable sensitivity**

**72.11 - Fixed sensitivity**

- Emptying or filling functions
- LED indicator
- Reinforced insulation (6 kV - 1.2/50 μs) between:
  - supply and contacts
  - electrodes and supply
  - contacts and electrodes
- 35 mm rail (EN 50022) mount
- Control about a single level or between Min./Max. limits
- 72.01 available also for supply 400 V

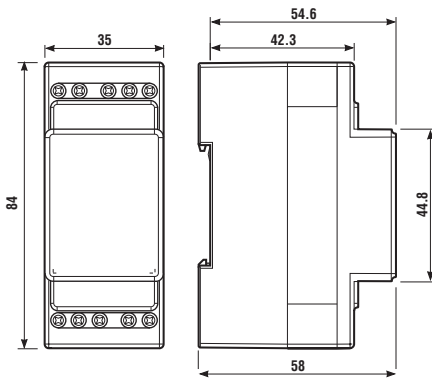

FOR UL HORSEPOWER AND PILOT DUTY RATINGS  
SEE "General technical information" page V

### 72.01



- Sensitivity range (5...150) kΩ adjustable
- Delay time (0.5s or 7s) switch selectable
- Emptying or filling functions switch selectable

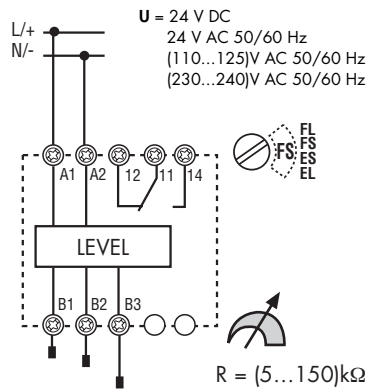

- FL = Filling - 7s delay
- FS = Filling - 0.5s delay
- ES = Emptying - 0.5s delay
- EL = Emptying - 7s delay

### 72.11



- Sensitivity fixed 150 kΩ
- Delay time fixed: 1 s
- Emptying or filling functions link selectable

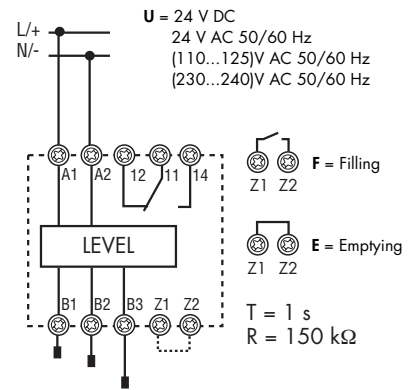

- T = 1 s
- R = 150 kΩ

#### Contact specification

Contact configuration	1 CO (SPDT)		1 CO (SPDT)
Rated current/Maximum peak current	A	16/30	16/30
Rated voltage/Maximum switching voltage V AC		250/400	250/400
Rated load AC1	VA	4,000	4,000
Rated load AC15 (230 V AC)	VA	750	750
Single phase motor rating (230 V AC)	kW	0.55	0.55
Breaking capacity DC1: 30/110/220 V	A	16/0.3/0.12	16/0.3/0.12
Minimum switching load	mW (V/mA)	500 (10/5)	500 (10/5)
Standard contact material		AgCdO	AgCdO

#### Supply specification

Nominal voltage (U <sub>N</sub> )	V AC	24 - 110...125 - 230...240	400	24 - 110...125 - 230...240
	V DC	24	—	24
Rated power AC/DC	VA (50 Hz)/W	2.5/1.5	2.5/1.5	2.5/1.5
Operating range	AC	(0.8...1.1)U <sub>N</sub>	(0.9...1.15)U <sub>N</sub>	(0.8...1.1)U <sub>N</sub>
	DC	(0.8...1.1)U <sub>N</sub>	—	(0.8...1.1)U <sub>N</sub>

#### Technical data

Electrical life at rated load AC1	cycles	100 · 10 <sup>3</sup>	100 · 10 <sup>3</sup>
Electrode voltage	V AC	4	4
Electrode current	mA	0.2	0.2
Run-on time	s	0.5 - 7 (selectable)	1
Max sensitivity range	kΩ	5...150 (adjustable)	150 (fixed)
Insulation between supply/contacts/electrode (1.2/50 μs)	kV	6	6
Ambient temperature	°C	-20...+60	-20...+60
Protection category		IP20	IP20

Approvals (according to type)



## Features

### 3 Phase - Rotation and phase loss monitoring relay

- Universal voltage monitoring ( $U_N$  from 208 V to 480 V, 50/60 Hz)
- Phase loss monitoring, under phase regeneration
- Positive safety logic - make contact opens if the relay detects an error
- Small size (17.5 mm wide)
- 35 mm rail (EN 50022) mount
- European patent pending for the fully innovative principle at the root of the 3 phase monitoring and error survey system

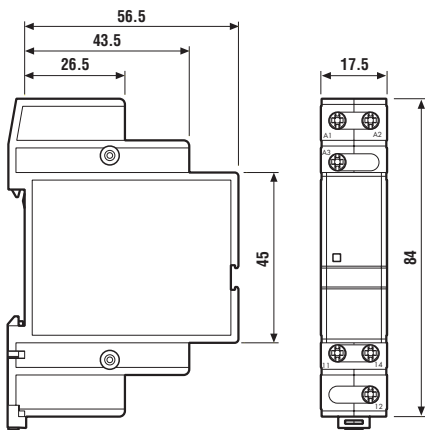

## 72.31



- Phase rotation monitoring
- Phase loss monitoring

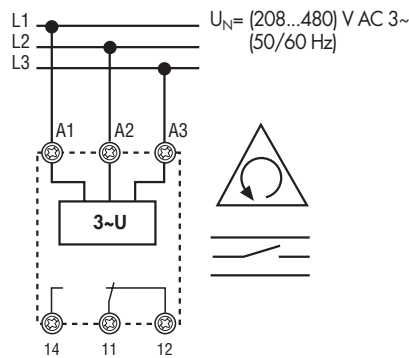

### Contact specification

Contact configuration		1 CO (SPDT)
Rated current/Maximum peak current	A	6/15
Rated voltage/Maximum switching voltage	V AC	250/400
Rated load AC1	VA	1,500
Rated load AC15 (230 V AC)	VA	250
Single phase motor rating (230 V AC)	kW	0.185
Breaking capacity DC1: 30/110/220 V	A	3/0.35/0.2
Minimum switching load	mW(V/mA)	500 (10/5)
Standard contact material		AgCdO

### Supply specification

Nominal system voltage ( $U_N$ )	V AC 3 ~	208...480
Frequency	Hz	50/60
Rated power	VA 50 Hz/ W	8/1
Operating range	V AC 3 ~	170...500

### Technical data

Electrical life at rated load AC1	cycles	$100 \cdot 10^3$
Switch-off/reaction time	s	<0.5/<0.5
Ambient temperature	°C	-20...+50
Protection category		IP20

### Approvals (according to type)



## Ordering information

### Level control relays

Example: 72 series level control relay, adjustable sensitivity range, (230...240)V AC supply voltage.

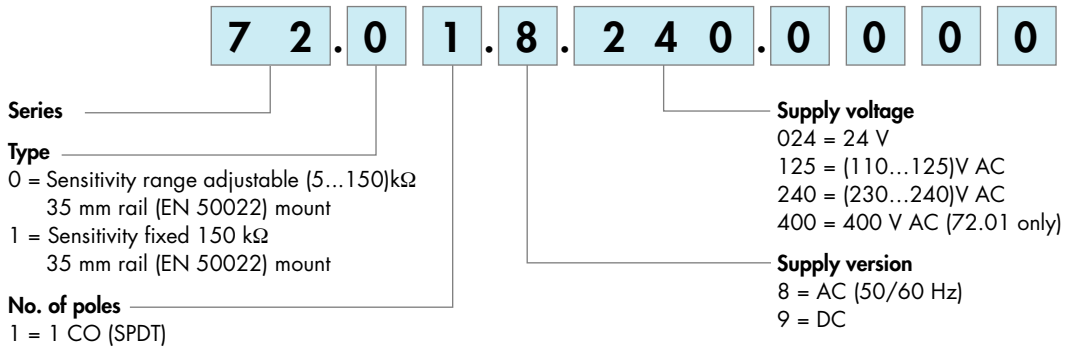

### Monitoring relays

Example : 3 phase line monitoring relay, phase rotation and loss monitoring, supply voltage (208...480)V AC 3~.

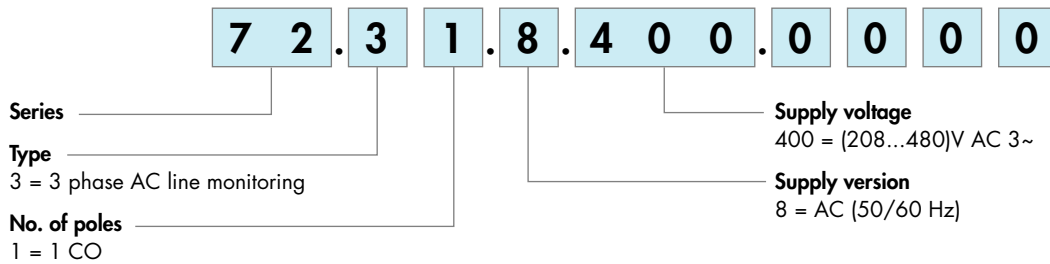

## Technical data for 72.01 and 72.11

Insulation			
Insulation		Dielectric strength	Impulse (1.2/50 µs)
	between supply and contacts	4,000 V AC	6 kV
	between electrodes, Z1-Z2 and supply*	4,000 V AC	6 kV
	between contacts and electrodes	4,000 V AC	6 kV
	between open contacts	1,000 V AC	1.5 kV
EMC specifications			
Type of test		Reference standard	
Electrostatic discharge	contact discharge	EN 61000-4-2	4 kV
	air discharge	EN 61000-4-2	8 kV
Radio-frequency electromagnetic field (80 ÷ 1000 MHz)		EN 61000-4-3	10 V/m
Fast transients (burst) (5-50 ns, 5 kHz) on Supply terminals		EN 61000-4-4	4 kV
Surges (1.2/50 µs) on Supply terminals		EN 61000-4-5	4 kV
Radio-frequency common mode (0.15 ÷ 80 MHz) on Supply terminals		EN 61000-4-6	10 V
Radiated and conducted emission		EN 55022	class B
Other data			
Current absorption on Z1 and Z2	mA	< 1	
Power lost to the environment	without contact current	W	1.5
	with rated current	W	3.2
Screw torque	Nm	0.8	
Max. wire size		solid cable	stranded cable
	mm <sup>2</sup>	1x6 / 2x4	1x4 / 2x2.5
	AWG	1x10 / 2x12	1x12 / 2x14
Max cable length between electrode and relay	m	200 (max. capacitance of 100 nF/km)	

\*There is no electrical isolation between electrodes and supply voltage for the 24 V DC types (72.x1.9.024.0000). Therefore, for SELV applications it would be necessary to use a SELV (non-grounded) power supply. In the case of a PELV (grounded) power supply take care to protect the level control relay against harmful circulating currents by ensuring that no electrodes are grounded.

However, there is no such problem for the 24 V AC types (72.x1.8.024.0000) which, by virtue of an internal isolating transformer, assure reinforced isolation between electrodes and supply.

## Technical data for 72.31

Insulation			
Insulation		Dielectric strength	Impulse (1.2/50 µs)
	between supply and contacts	3,000 V	5 kV
	between open contacts	1,000 V	1.5 kV
EMC specifications			
Type of test		Reference standard	
Electrostatic discharge	contact discharge	EN 61000-4-2	4 kV
	air discharge	EN 61000-4-2	8 kV
Fast transients (burst) (5-50ns, 5kHz) on A1, A2, A3		EN 61000-4-4	2 kV
Surge (1.2/50 µs)	differential mode	EN 61000-4-5	4 kV
Other data			
Start up time (NO contact closure after energising)	s	< 2	
Regeneration level (Maximum)		≤ 80% of average of other 2 phase	
Power lost to the environment	without contact current	W	1
	with rated current	W	1.4
Screw torque	Nm	0.8	
Max. wire size		solid cable	stranded cable
	mm <sup>2</sup>	1x6 / 2x4	1x4 / 2x2.5
	AWG	1x10 / 2x12	1x12 / 2x14

## Functions for 72.01 and 72.11

- U** = Supply voltage
- B1** = Max level electrode
- B2** = Min level electrode
- B3** = Common
- = Contact 11-14
- Z1-Z2** = Link to select emptying (Type 72.11)

LED	Supply voltage	NO output contact	Contacts	
			Open	Closed
	OFF	Open	11 - 14	11 - 12
	ON	Open	11 - 14	11 - 12
	ON	Open (Timing in Progress)	11 - 14	11 - 12
	ON	Closed	11 - 12	11 - 14

### Function and Run-on time

#### Type 72.01

- FL** = Level control by Filling, Long (7sec) run-on delay.
- FS** = Level control by Filling, Short (0.5sec) run-on delay.
- ES** = Level control by Emptying, Short (0.5sec) run-on delay.
- EL** = Level control by Emptying, Long (7sec) run-on delay.

#### Type 72.11

- F** = Level control by Filling, Z1-Z2 open. Run-on time fixed at 1sec.
- E** = Level control by Emptying, Z1-Z2 linked. Run-on time fixed at 1sec.

## Filling functions

### Wiring diagram

Examples with **3 electrodes**

#### Type 72.01

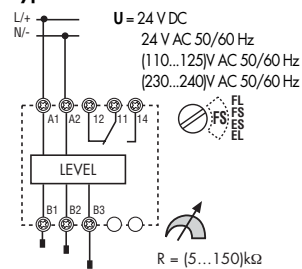

#### Type 72.11

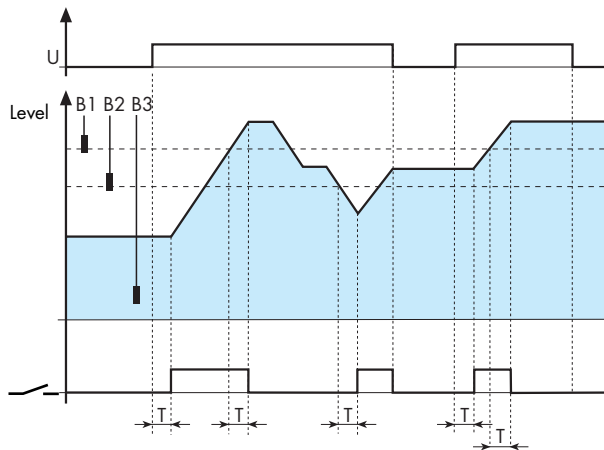
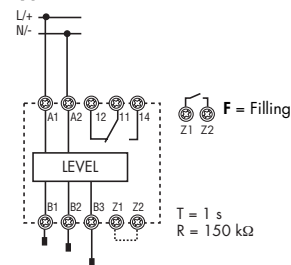

**Filling Control** – between Min. and Max. levels.  
Under normal operation the liquid level can be expected to cycle between the Minimum and the Maximum electrodes, B2 and B1 (plus a degree of over and under-shoot).

- Switch On:**
- On "power-up", if the liquid is below B1 the output relay will operate after time T has expired.
  - On the liquid level falling below B2, the output relay will operate after time T has expired.

- Switch Off:**
- On the liquid level reaching electrode B1, the output relay will de-energise after time T has expired.
  - On "power-off", the output relay will immediately de-energise.

### Wiring diagram

Examples with **2 electrodes**

#### Type 72.01

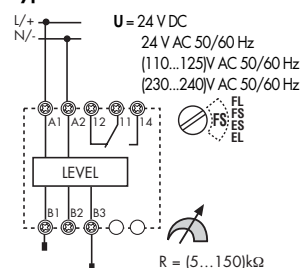

#### Type 72.11

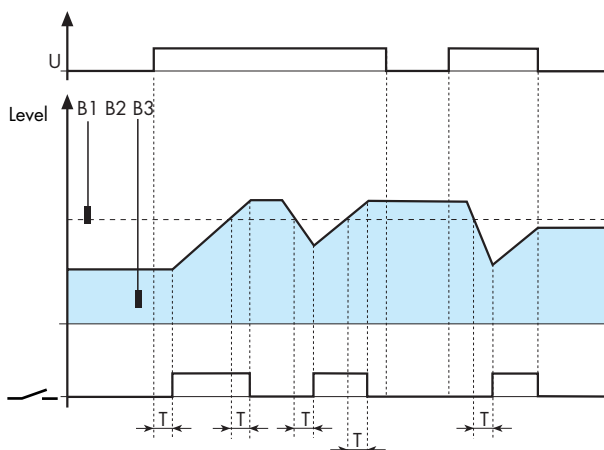
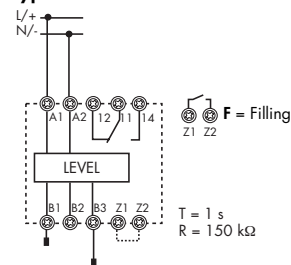

**Filling Control** – about a single level, B1.  
Under normal operation the liquid level can be expected to cycle about the level set by electrode B1 with a degree of over and under-shoot.

- Switch On:**
- On "power-up", if the liquid is below B1 the output relay will operate after time T has expired.
  - On the liquid level falling below B1, the output relay will operate after time T has expired.

- Switch Off:**
- On the liquid level reaching electrode B1, the output relay will de-energise after time T has expired.
  - On "power-off", the output relay will immediately de-energise.

## Emptying functions

### Wiring diagram

### Examples with 3 electrodes

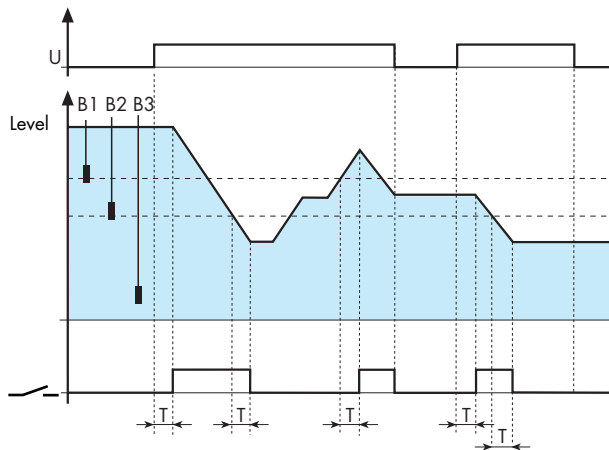
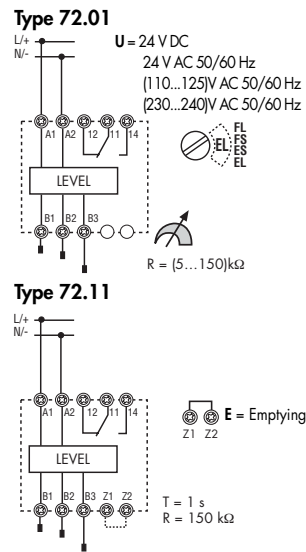

### Emptying Control – between Max. and Min. levels.

Under normal operation the liquid level can be expected to cycle between the Maximum and the Minimum electrodes, B1 and B2 (plus a degree of over and under-shoot).

### Switch On:

- On “power-up”, if the liquid level is above B2 the output relay will operate after time T has expired.
- On the liquid level rising to B2, the output relay will operate after time T has expired.

### Switch Off:

- On the liquid level falling below electrode B2, the output relay will de-energise after time T has expired.
- On “power-off”, the output relay will immediately de-energise.

### Wiring diagram

### Examples with 2 electrodes

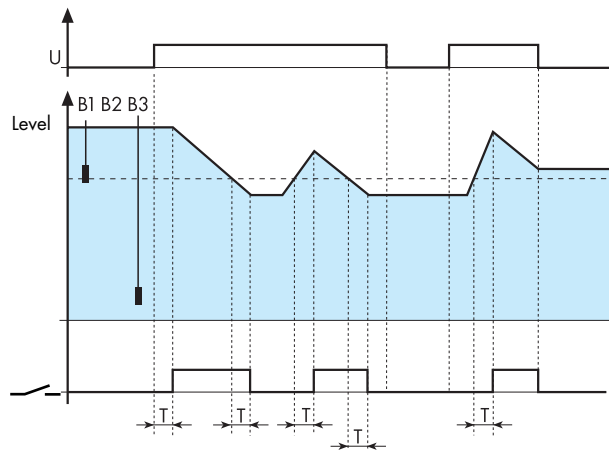
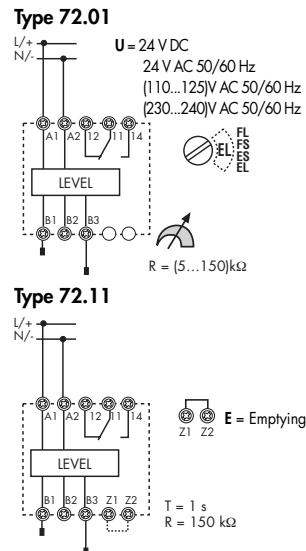

### Emptying Control about a single level, B1.

Under normal operation the liquid level can be expected to cycle about the level set by electrode B1 with a degree of over and under-shoot.

### Switch On:

- On “power-up”, if the liquid is above B1 the output relay will operate after time T has expired.
- On the liquid level rising to B1, the output relay will operate after time T has expired.

### Switch Off:

- On the liquid level falling below electrode B1, the output relay will de-energise after time T has expired.
- On “power-off”, the output relay will immediately de-energise.

## Applications for 72.01 and 72.11

### FILLING function:

Examples with 3 electrodes and with a contactor connected to the contact.

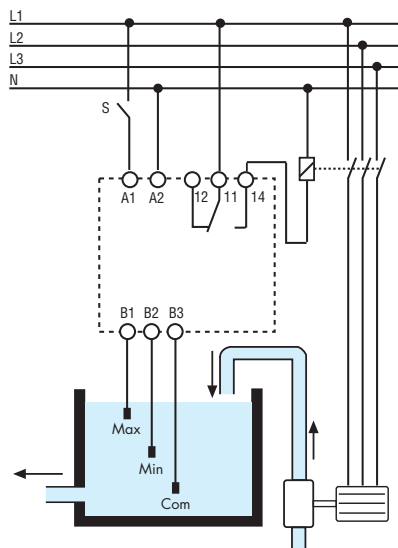

### EMPTYING function:

Examples with 3 electrodes and with a motor pump connected directly to the contact.

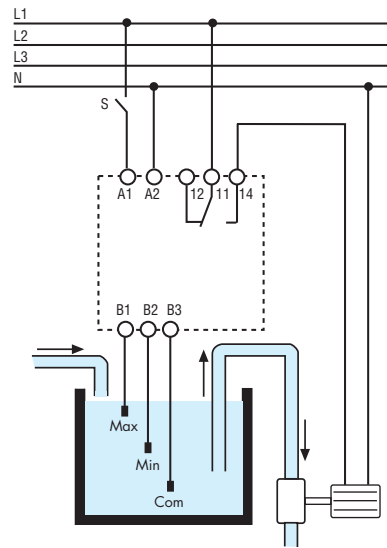

The 72 series level control relays work by measuring the resistance through the liquid, between the common (B3) electrode and Min. and Max. electrodes (B2 and B1). If the tank is metallic, then this can be substituted as the B3 electrode.

Take care to ensure that the liquid has a suitable resistivity – see below:

### SUITABLE LIQUIDS

- City water
- Well water
- Rainwater
- Sea water
- Liquids with low-percentage alcohol
- Wine
- Milk, Beer, Coffee
- Sewage
- Liquids fertilizer

### UN-SUITABLE LIQUIDS

- Demineralised water
- Fuels
- Oil
- Liquids with high-percentage alcohol
- Liquid gas
- Paraffins
- Ethylene glycol
- Paint

## Functions for 72.31

L1, L2, L3 = Supply voltage

= Contact 11-14

LED status		Supply voltage	NO output contact	Contacts	
			Open	Open	Closed
	Supply voltage OFF	OFF	Open	11 - 14	11 - 12
	- Incorrect phase rotation - Phase loss	ON			
	Normal operation	ON	Closed	11 - 12	11 - 14

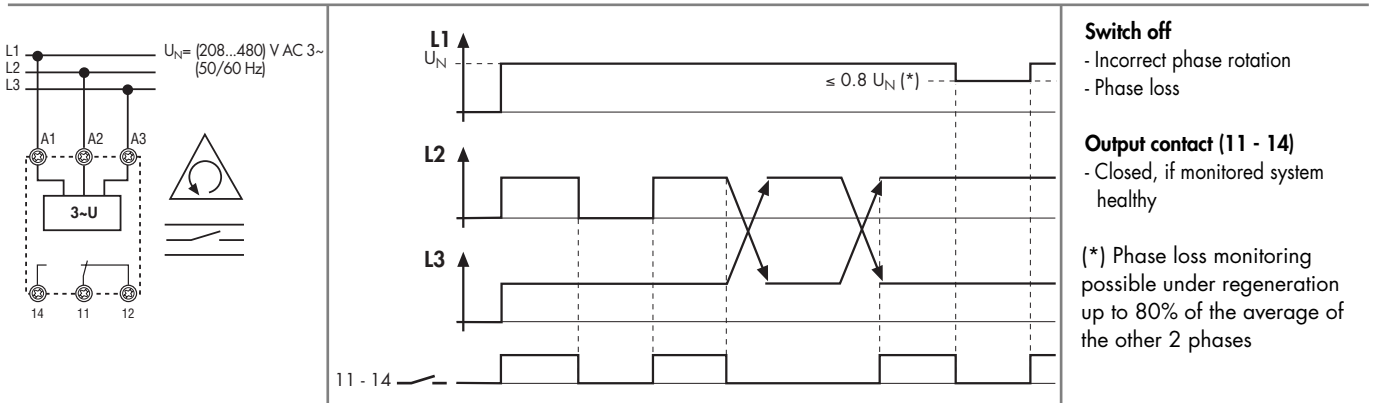

## Accessories for 72.01 and 72.11



072.01.06

**Suspended electrode for conductive liquids**, complete with cable. Suitable for level monitoring in wells and reservoirs not under pressure. All materials used are compatible with food processing applications (according to European Directive 2002/72 and cod. FDA title 21 part 177).

Order appropriate number of electrodes - additional to the relay.

Cable length: 6 m (1.5 mm<sup>2</sup>)

072.01.06

Cable length: 15 m (1.5 mm<sup>2</sup>)

072.01.15

### Technical data

Max. liquid temperature °C +100

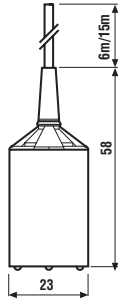

072.51

**Electrode holder with two pole connector**, one connected directly to the electrode and the second connected to the grounded installation thread. Suitable for metal tank with G3/8" linkage.

Electrode not included. Order appropriate number of electrodes holders - additional to the relay.

072.51

### Technical data

Max liquid temperature °C + 100

Max tank pressure bar 12

Cable grip mm  $\varnothing \leq 6$

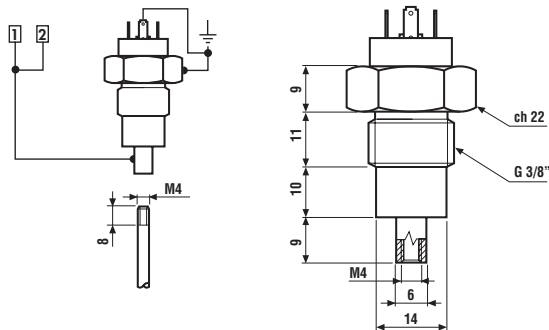

072.53

**Electrode holder with three poles**. Electrode not included.

Order appropriate number of electrodes holders - additional to the relay.

072.53

### Technical data

Max liquid temperature °C + 130

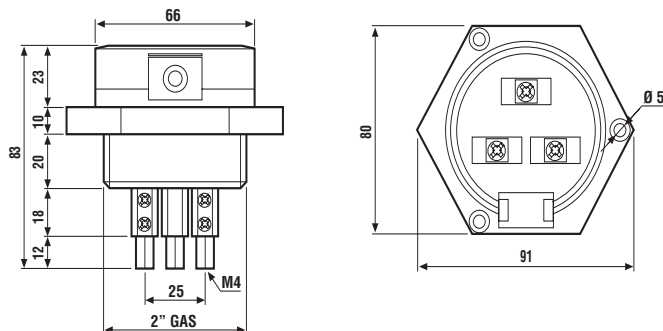



## Accessories for 72.01 and 72.11

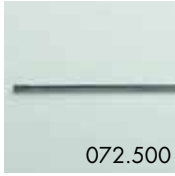

**Electrode and electrode connector**, multiple electrodes may be interconnected to provide required length

### Technical data

Electrode - 500 mm long, M4 thread, stainless steel	072.500
Inter-electrode connector - M4 thread, stainless steel	072.501



Illustration of interconnection of electrodes.



## Application notes for 72.01 and 72.11

### Applications

The main application for these relays is for the sensing and control of the level of conductive liquids.

Selectable options allow for this control to be achieved either through a filling operation or through an emptying operation, and in either case "positive logic" is used.

Level control can be achieved around a single level – using 2 electrodes, or between Minimum and Maximum levels – using 3 electrodes.

Additionally, the 72.01, with its adjustable sensitivity setting, can be ideal for monitoring the conductivity of liquids.

### Positive safety logic

These relays work according to the principle that it is the closure of a normally open output contact that will be used to control the pump, both in filling and emptying applications. Consequently, in the event of a failure of the supply local to the relay, the filling or emptying will cease. This is generally considered to be the safest option.

### Overrunning of tank on filling

Care must be exercised to ensure that the tank cannot overrun. Factors that have to be considered are the pump performance, the rate of discharge from the tank, the position of the single level electrode (or maximum electrode), and the run-on time delay. Keeping the time delay to a minimum will minimise the possibility of tank overrun, but will increase the installed switching rate.

### Prevent dry running of pump on emptying

Care must be exercised to ensure that the pump cannot run dry. Similar considerations must be given as outlined above. In particular, keeping the run-on time delay to a minimum will minimise the risk, but again, it will increase the installed switching rate.

### Run-on time

In commercial and light industrial applications the use of a short Run-on time delay is more appropriate, due to the relatively small size of tanks and the consequential need to react quickly to the change in level. Larger scale industrial applications involving larger tanks and powerful pumps must avoid a frequent switching cycle, and the use of the 72.01 set for the longer Run-on time of 7 seconds is suggested.

Note that the short run-on time will always achieve closer control to the desired level(s), but at the cost of more frequent switching.

### Electrical life of the output contact

The electrical life of the output contact will be enhanced where a larger distance between the Max. and Min. electrodes (3-electrode control) can be realised. A smaller distance, or level control to a single level (2-electrode control), will result in more frequent switching and therefore a shorter electrical life for the contacts. Similarly, the long run-on time will enhance, and the short time will reduce, electrical life.

### Pump control

Small single-phase pumps within the kW (0.55 kW - 230 V AC) rating stated may be driven directly by the level relay output contact. However, where very frequent switching is envisaged, it is better to "slave" a higher power relay or contactor to drive the pump motor. Large pumps (single-phase and three-phase) will of course require an interposing contactor.

### Electrodes and cable lengths

Normally 2 electrodes or 3 electrodes will be required for control about a single level, or control between Min. and Max. levels, respectively. However, if the tank is made of conductive material it is possible to use this as the common electrode, B3, if electrical connection can be made to it.

The maximum permitted length of cable between the electrode and the relays is 200m, for a cable not exceeding 100nF/km.

A maximum of 2 relays and associated electrodes can be employed in the same tank – if two different levels need monitoring.

Note: It is permitted to make direct electrical connection between terminals B1-B3, and B2-B3, (without using electrodes/liquid), but in this case it is not possible to set up the sensitivity.

### Electrode choice

The choice of electrodes may depend on the liquid being monitored. Standard electrodes 072.01.06 and 072.51 are suitable for many applications but some liquids may be corrosive for example, and may therefore require custom made electrodes - but these can usually be used with the 72.01 and 72.11 relays.

### On site commissioning

To confirm the suitability of the relay sensitivity to the resistance between electrodes it is suggested that the following checks are made. For convenience it is suggested that the fill function and the shortest run-on time are selected.

### Commissioning

Follow these setting-up instructions to achieve correct operation:

#### 72.01

Select the function "FS" (Filling and Short delay of 0.5 s), and set the sensitivity control to 5 k $\Omega$ . Ensure that all electrodes are immersed in the liquid - expect the output relay to be ON. Then, slowly rotate the sensitivity control in the 150 k $\Omega$  direction until the level relay switches OFF (internal output relay will switch OFF and red LED will switch slowly flash).

(If the level relay does not switch OFF then, either the electrodes are not immersed, or the liquid has too high impedance or the distance between electrodes is too long).

Finally, select the filling or emptying function as required, run in real time and confirm that the level relay works as required.

#### 72.11

Select the Filling function "F", (Z1 – Z2 open). Ensure that all electrodes are immersed in the liquid, but leave electrode B3 disconnected – output relay should be ON. Connect electrode B3, and the level relay should switch OFF

(internal output relay will switch OFF and red LED will switch slowly flash).

(If the level relay does not switch OFF then, either the electrodes are not immersed, or the liquid has too high impedance or the distance between electrodes is too long.)

Finally, select the filling or emptying function as required, run in real time and confirm that the level relay works as required.