

THESE DRAWINGS ARE THE PROPERTY OF QUALTEK ELECTRONICS AND NOT TO BE REPRODUCED FOR OR COMMUNICATED TO A THIRD PARTY WITHOUT THE EXPRESS WRITTEN PERMISSION OF AN OFFICER OF QUALTEK ELECTRONICS.

REVISION			
REV.	DESCRIPTION	DATE	APPROVED
B	RoHS Compliancy	06-01-06	DP

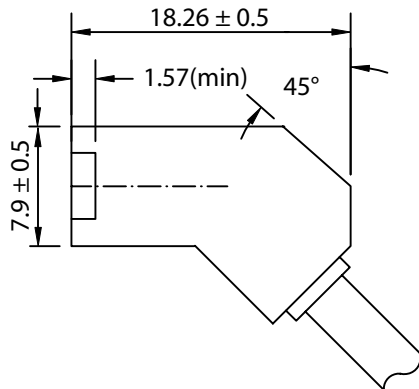
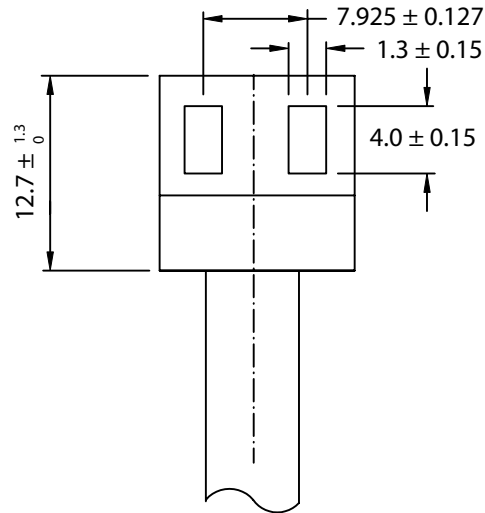

NOTES:

1. UL LISTED (10 AMP/125 V)  
CSA CERTIFIED (7 AMP/125 V)
2. CORDAGE: SPT-1, 18/2, 105°C, 300V
3. CORD LENGTH: 60 INCHES
4. TERMINATION: BLUNT CUT
5. RoHS COMPLIANT

**CONTROLLED**

Dim range (mm)	Tolerance +/- (mm)	Qualtek Electronics Corp. FAN-S DIVISION		
		Part Number: 07145-60		RoHS Compliant
0-1	0.15	Description: MOLDED FAN CORD FEMALE 45°		
1-6	0.20	UNIT: mm		
6-18	0.30			
18-50	0.50	REV: B		
50-120	0.70	Drawn / Date	Checked / Date	Approved / Date
120-250	0.90	K.Huang 08-21-98	08-21-98	JJH / 08-21-98
250-500	1.20			