

Thermal device circuit breaker - TCP 8A - 0712291

Please be informed that the data shown in this PDF Document is generated from our Online Catalog. Please find the complete data in the user's documentation. Our General Terms of Use for Downloads are valid (<http://phoenixcontact.com/download>)



Thermal miniature circuit breaker, pluggable in screw-type fuse terminal block UK 6-FSI/C and spring-cage fuse terminal block ST 4-FSI/C

The illustration shows version TCP 2A

Product Features

- A version with screw or spring-cage connection is used as a basic terminal block
- The reclosable thermal circuit breaker is available in ten nominal current levels ranging from 0.1 to 10 A
- Compact design
- The integrated switching function enables immediate reclosure and therefore ensures the availability of the system



Key Commercial Data

Packing unit	1 pc
Weight per Piece (excluding packing)	10.67 g
Custom tariff number	85362010
Country of origin	Indonesia

Technical data

General

Installation instructions	When mounted in rows, the nominal device current can be limited to just 80% or must be overdimensioned accordingly.
Mounting type	On base element
Color	black
Number of positions	1
Overvoltage category	II
Insulating material	PPS
Flammability rating according to UL 94	V0

Electrical data

Thermal device circuit breaker - TCP 8A - 0712291

Technical data

Electrical data

Fuse	Slow-blow
Fuse type	Automatic device
Rated surge voltage	2.5 kV
Rated voltage	250 V AC
	65 V DC
	250 V (AC according to UL 1077)
	72 V (DC according to UL 1077)
Rated current I_N	8 A
Insulation resistance R_{iso}	> 100 M Ω (500 V DC)
Rated short-circuit switching capacity I_{cn}	64 A (250 V AC / 65 V DC)
	160 A (30 V DC)
Short-circuit switching capacity I_k	2000 A 250 V AC / UL 1077
	2000 A 72 V DC / UL 1077
Dielectric strength	3000 V AC (Actuation area)
	1500 V AC (Installation area)
Switching cycles, max.	6000 (At 1 x I_n , low-induction)
	3000 (At 1 x I_n , inductive)
	500 (At 2 x I_n , inductive)
Degree of pollution	2
Overvoltage category	II
Insulating material group	IIIb

Dimensions

Height	24.4 mm
Width	8.2 mm
Depth	44.5 mm
Height NS 35/7,5	55 mm

Ambient conditions

Degree of protection	IP40 (Actuation area)
Ambient temperature (operation)	-20 °C ... 60 °C

Standards and Regulations

Standards/specifications	EN 60934
--------------------------	----------

Thermal device circuit breaker - TCP 8A - 0712291

Classifications

eCl@ss

eCl@ss 4.0	27141116
eCl@ss 4.1	27141116
eCl@ss 5.0	27141116
eCl@ss 5.1	27141116
eCl@ss 6.0	27141116
eCl@ss 7.0	27141116
eCl@ss 8.0	27141116

ETIM

ETIM 2.0	EC000899
ETIM 3.0	EC000899
ETIM 4.0	EC000899
ETIM 5.0	EC000899

UNSPSC

UNSPSC 6.01	30211812
UNSPSC 7.0901	39121411
UNSPSC 11	39121411
UNSPSC 12.01	39121411
UNSPSC 13.2	39121411

Approvals

Approvals

Approvals

CSA / UL Recognized / VDE Zeichengenehmigung / cUL Recognized / EAC / EAC / cULus Recognized

Ex Approvals

Approvals submitted

Approval details

Thermal device circuit breaker - TCP 8A - 0712291

Approvals

CSA	
Nominal current I _N	8 A
Nominal voltage U _N	250 V

UL Recognized

VDE Zeichengenehmigung

cUL Recognized

EAC

EAC

cULus Recognized

Drawings

Thermal device circuit breaker - TCP 8A - 0712291

Diagram

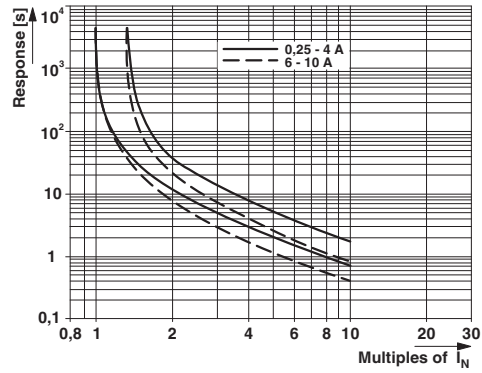

Application drawing

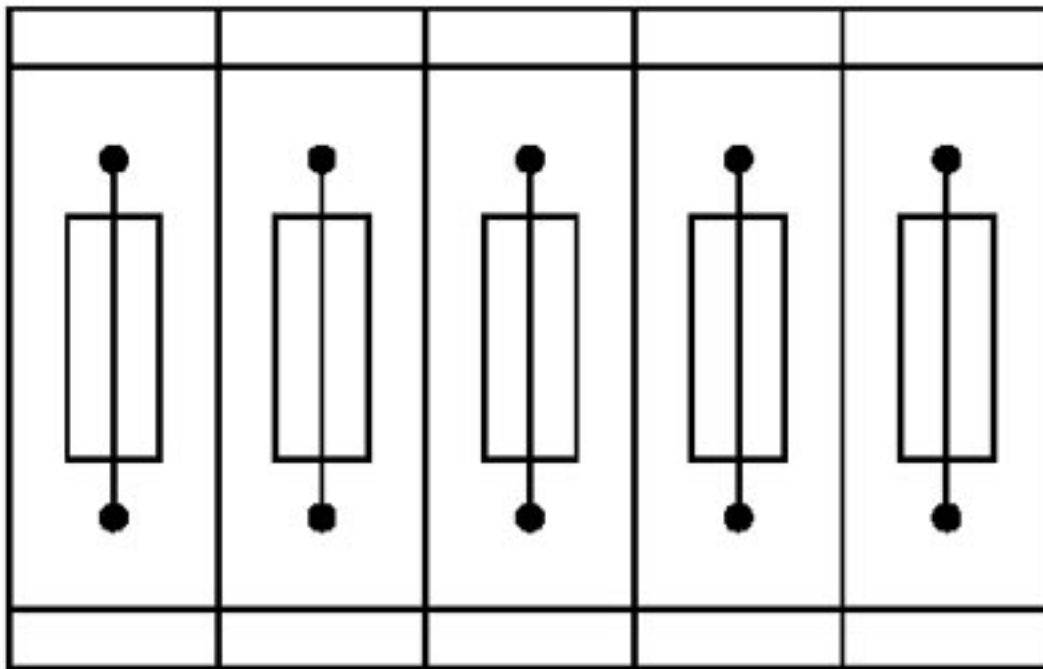

Fuse terminal blocks in interconnected arrangement, block consisting of 5 fuse terminal blocks

Thermal device circuit breaker - TCP 8A - 0712291

Application drawing

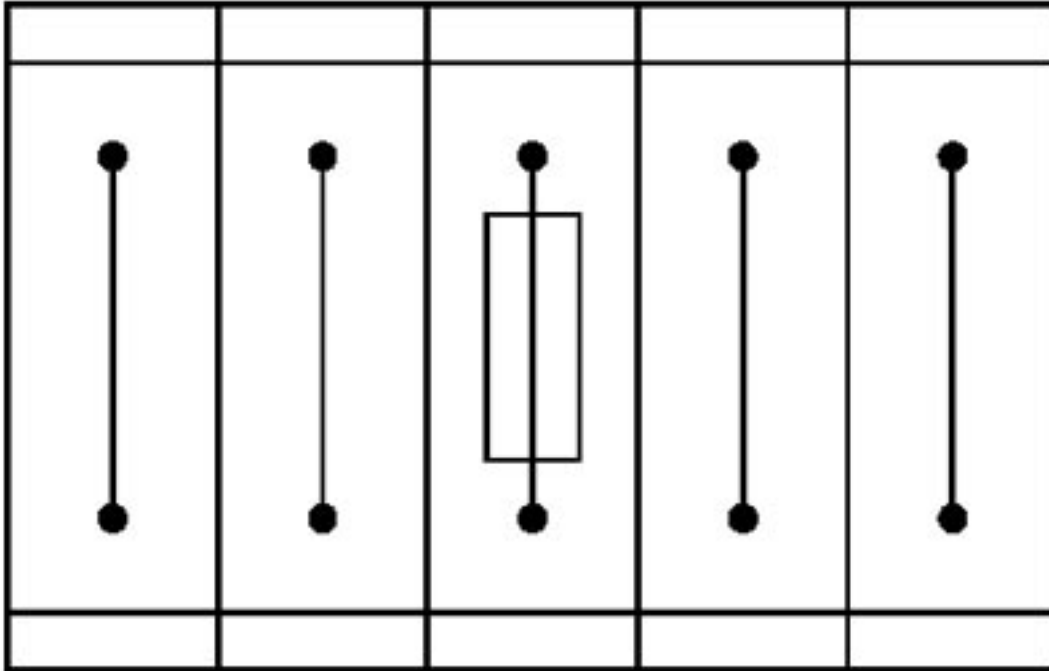

Fuse terminal block in single arrangement,
block consisting of one fuse terminal block and 4 feed-through terminal blocks

Thermal device circuit breaker - TCP 8A - 0712291

Dimensional drawing

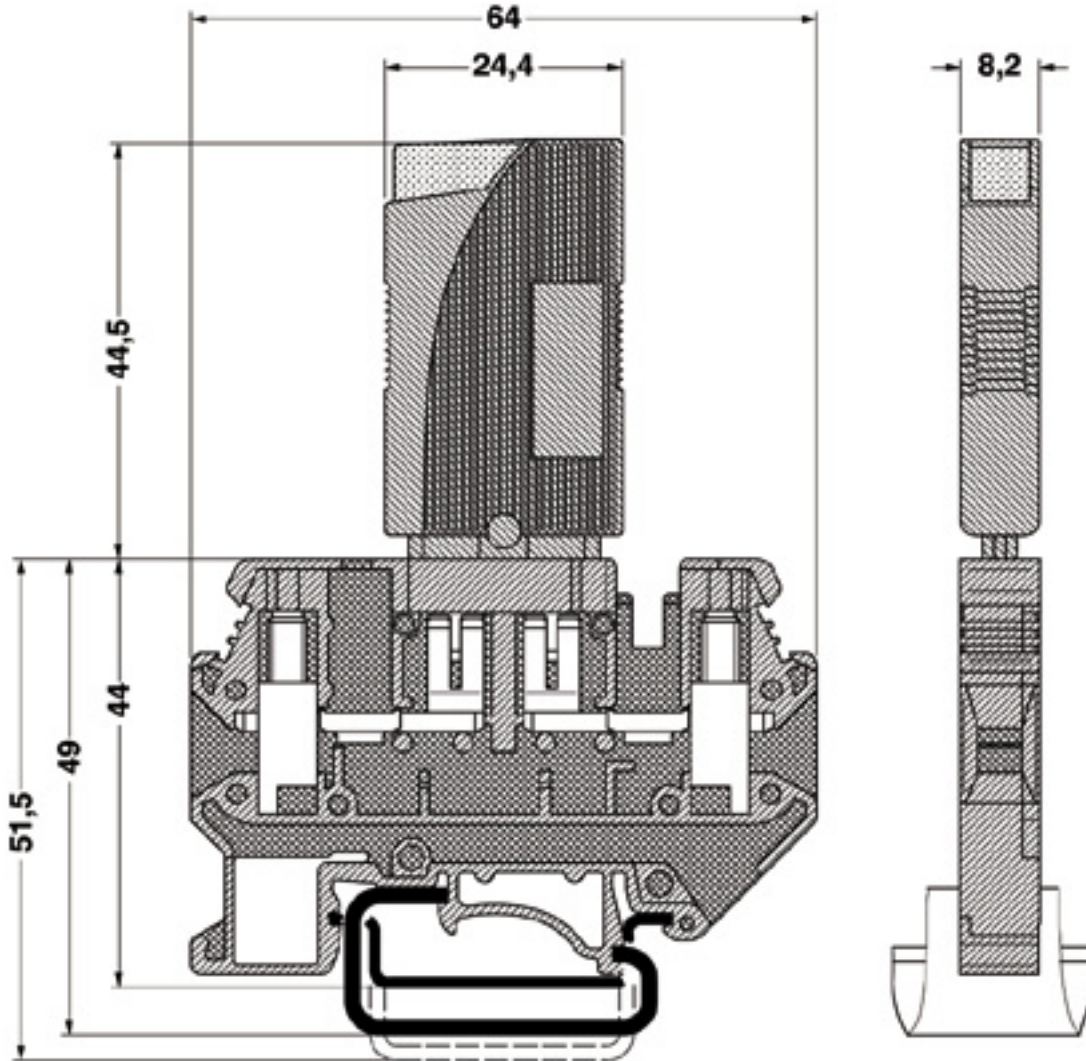

Thermal device circuit breaker - TCP 8A - 0712291

Dimensional drawing

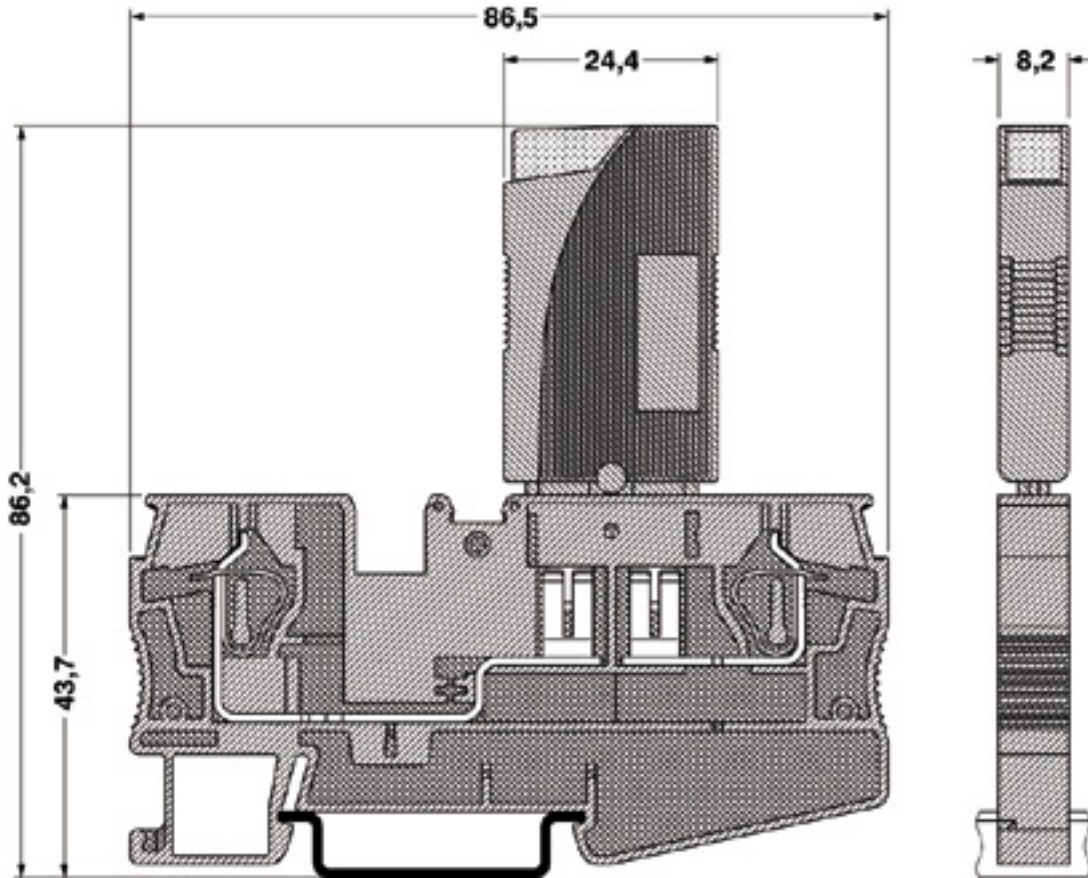

Thermal device circuit breaker - TCP 8A - 0712291

Application drawing

