

03

0315

Circular connectors with threaded joint M16 acc. to IEC 61076-2-106, IP40/IP67/IP68



Chassis plug acc. to IEC 61076-2-106, IP68, with threaded joint and solder terminals, for back side mounting

03 0315

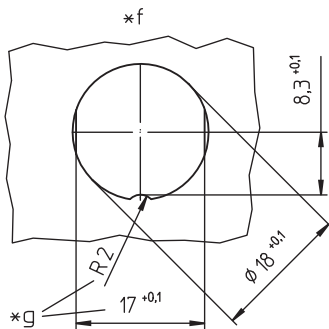
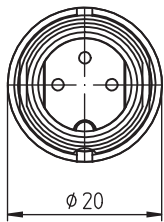
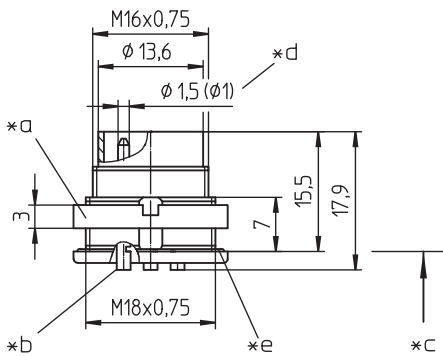
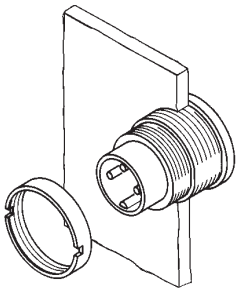

Environmental conditions

Temperature range -40 °C/+85 °C

Materials

Insulating body	PA GF, V-0 according to UL94
Contact pin	CuZn, silver-plated and flash gold-plated (3-8 poles) CuZn, pre-nickel and gold-plated (12-14 poles)
Housing	Zn diecast, pre-copper and nickel-plated
Ring screw	CuZn, nickel-plated
Seal	NBR

Mechanical data

Tightening torque connector	1-3 Nm
Tightening torque nut	1-3 Nm
Protection class	IP68 ¹
Further data	depending on pin configuration, see below

¹ according to IEC DIN EN 60529, only in locked condition with an appropriate counterpart; IPX8 requirements under agreement between manufacturer and user

Connectable conductors for solder area

Section	≤ 0,75 mm ² (AWG 20) (3-8 poles) ≤ 0,25 mm ² (AWG 24) (12-14 poles)
---------	--

Electrical data (at T_{amb} 20 °C)

Rated current	5 A (T _{amb} 40 °C, 3-8 poles) 3 A (T _{amb} 40 °C, 12-14 poles)
Rated voltage	with pollution degree 1: 300 V (versions 03, 04, 05-1, 06, 07) 100 V (versions 05, 07-1, 08, 08-1) 160 V (versions 12, 14) with pollution degree 2: 250 V (versions 03, 04) 32 V (versions 05, 07-1, 08, 08-1) 160 V (versions 05-1, 06, 07, 12, 14)
Rated impulse voltage	1500 V (versions 03, 04, 05-1, 06, 07, 12, 14) 500 V (versions 05, 07-1, 08, 08-1)
Material group	II (IEC)/1 (UL) (400 ≅ CTI < 600)
Overvoltage category	I
Insulation resistance	> 100 MΩ

03

0315

Pin configurations, solder side view

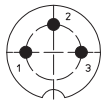

03-a
0315 03

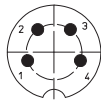

04-a
0315 04

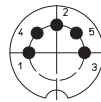

05-b
0315 05

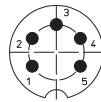

05-a
0315 05-1

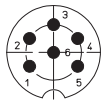

06-a
0315 06

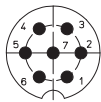

07-a
0315 07

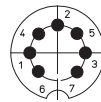

07-b
0315 07-1

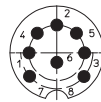

0315 08

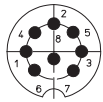

08-a
0315 08-1

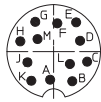



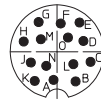



12-a
0315 12







14-a
0315 14

Associated products

Counterparts

 0321	 0322	 0322-1
 032200	 0360	 036000

Accessories

 0383	 038399	 0384
 0385	 038899	

- *a nut enclosed separately
- *b cup-shaped solder terminal
- *c mounting direction
- *d contact pin
Ø 1.5 mm (0315 03–0315 08-1)
Ø 1.0 mm (0315 12–0315 14)
- *e O-ring gasket
- *f port in mounting plate
- *g anti-rotation, alternative execution

03

0315

Designation	Pole Number	PU (Pieces)	MDQ (Pieces)
0315 03	3	50	100
0315 04	4	50	100
0315 05	5	50	100
0315 05-1	5	50	100
0315 06	6	50	100
0315 07	7	50	100
0315 07-1	7	50	100
0315 08	8	50	100
0315 08-1	8	50	100
0315 12	12	50	100
0315 14	14	50	100

Packaging:

in a cardboard box