

03 0307

Circular connectors with threaded joint M16 acc. to IEC 61076-2-106, IP40/IP67/IP68



Chassis socket acc. to IEC 61076-2-106, IP68, with threaded joint, for printed circuit boards, for back side mounting

03 0307

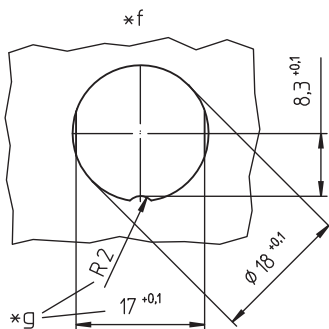
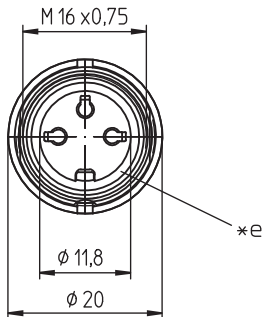
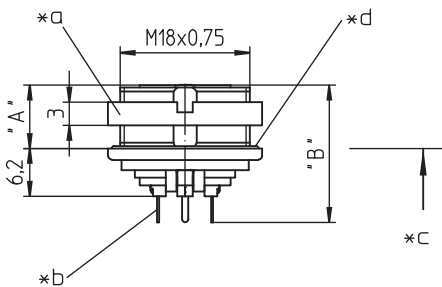
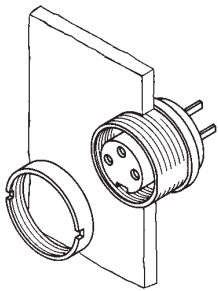

### Environmental conditions

Temperature range -40 °C/+85 °C

### Materials

Insulating body	PA GF, V-0 according to UL94
Contact bush	CuZn, silver-plated and flash gold-plated, tin-plated in solder area (3-8 poles) CuZn, pre-nickel and gold-plated, tin-plated in solder area (12-14 poles)
Housing	Zn diecast, pre-copper and nickel-plated
Ring screw	CuZn, nickel-plated
Seal	CR (flat), NBR (O-ring)

### Mechanical data

Insertion force/contact	≤ 5.0 N <sup>1</sup>
Withdrawal force/contact	≥ 1.2 N (3-8 poles) ≥ 0.9 N (12-14 poles) <sup>1</sup>
Tightening torque connector	1-3 Nm
Tightening torque nut	1-3 Nm
Protection class	IP68 <sup>2</sup>

<sup>1</sup> measured with a polished steel pin, nominal thickness 1.5 mm (1.0 mm with 12-14 poles)

<sup>2</sup> according to IEC DIN EN 60529, only in locked condition with an appropriate counterpart; IPX8 requirements under agreement between manufacturer and user

### Electrical data (at T<sub>amb</sub> 20 °C)

Contact resistance	≤ 5 mΩ
Rated current	5 A (T <sub>amb</sub> 40 °C, 3-8 poles) 3 A (T <sub>amb</sub> 40 °C, 12-14 poles)
Rated voltage	with pollution degree 1: 300 V (versions 03, 04, 05-1, 06, 07) 100 V (versions 05, 07-1, 08, 08-1) 160 V (versions 12, 14) with pollution degree 2: 250 V (versions 03, 04) 32 V (versions 05, 07-1, 08, 08-1) 160 V (versions 05-1, 06, 07, 12, 14)
Rated impulse voltage	1500 V (versions 03, 04, 05-1, 06, 07, 12, 14) 500 V (versions 05, 07-1, 08, 08-1)
Material group	II (IEC)/I (UL) (400 ≤ CTI < 600)
Overvoltage category	I
Insulation resistance	> 100 MΩ

03

0307

Pin configurations, solder side view

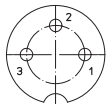

**03-a**  
**0307 03**

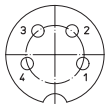

**04-a**  
**0307 04**

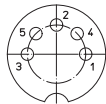

**05-b**  
**0307 05**

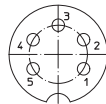

**05-a**  
**0307 05-1**



**06-a**  
**0307 06**

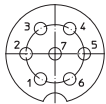

**07-a**  
**0307 07**

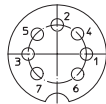

**07-b**  
**0307 07-1**



**0307 08**



**08-a**  
**0307 08-1**





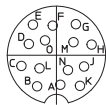



**12-a**  
**0307 12**









**14-a**  
**0307 14**

Associated products

Counterparts

 0331	 0332	 0332-1
 033200	 0365	 036500

Accessories

 0322 C 16	 0381	 038199
 0384	 0385	 038799

03 0307

Printed circuit board layout, solder side view

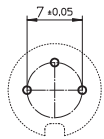

03-a  
0307 03

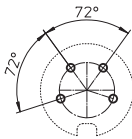

04-a  
0307 04

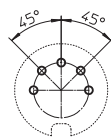

05-b  
0307 05

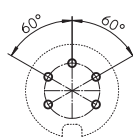

05-a  
0307 05-1

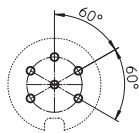

06-a  
0307 06

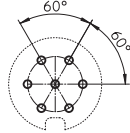

07-a  
0307 07

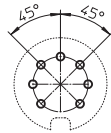

07-b  
0307 07-1

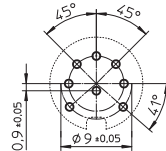

0307 08

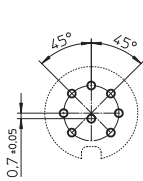

08-a  
0307 08-1

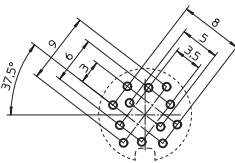

12-a  
0307 12

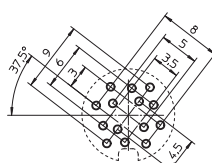

14-a  
0307 14

- \*a nut enclosed separately
- \*b for bore hole of PCB  
Ø 1,0 mm (0307 03-0307 08-1)  
Ø 0,7 mm (0307 12-0307 14)
- \*c mounting direction
- \*d O-ring gasket
- \*e flat gasket
- \*f port in mounting plate
- \*g anti-rotation, alternative execution

03

0307

Designation	Pole Number	PU (Pieces)	MDQ (Pieces)	Dimensions	
				A (mm)	B (mm)
0307 03	3	50	100	8.2	17.8
0307 04	4	50	100	8.2	17.8
0307 05	5	50	100	8.2	17.8
0307 05-1	5	50	100	8.2	17.8
0307 06	6	50	100	8.2	17.8
0307 07	7	50	100	8.2	17.8
0307 07-1	7	50	100	8.2	17.8
0307 08	8	50	100	8.2	17.8
0307 08-1	8	50	100	8.2	17.8
0307 12	12	50	100	7.9	17.1
0307 14	14	50	100	7.9	17.1

**Packaging:**

in a cardboard box